

Bring
Technology
to Life



Real-time PCR System

Gentier 96E/96T/96R



USER MANUAL

Xi'an Tianlong Science and Technology Co., Ltd.

Real-time PCR System

User Manual

Xi'an Tianlong Science and Technology Co., Ltd.

Bring Technology to Life

Disclaimer and Copyright

Copyright ©(2017-2024) **Xi'an Tianlong Science and Technology Co., Ltd.** (hereinafter referred to as **XATL Co., Ltd.**). All rights reserved.

All contents of this manual (including but not limited to text, trademark, logo, buttons icons, graphics, tables, data, etc.) are subject to the copyright and other intellectual property rights of **XATL Co., Ltd.** These materials shall not be reproduced in any form, neither mechanical nor electronic, nor translated into any other languages without the express written permission of **XATL Co., Ltd.**

Every effort has been made to ensure that all the information contained in this manual is correct at the time of publishing. However, **XATL Co., Ltd.** reserves the right to make any changes necessary. The contents of this manual are subject to change without prior notice at any time, and the updated revision prevails.

User Manual Version: V2.8

User Manual Document No.: 16EC22ESTRC

User Manual Revision Time: 1-Jul.-2024

Suitable Instrument Model: Gentier 96E, Gentier 96T, Gentier 96R



is a registered trademark for **Xi'an Tianlong Science and Technology corporate limited.**

Intended Use

The Gentier real-time PCR system (hereinafter referred to as **Gentier instrument**) is intended for performing rapid, accurate polymerase chain reaction (PCR), meanwhile real-time measuring nucleic acid signals from DNA-binding fluorescent dyes or labeled probes and converts them to comparative quantitative readouts of DNA or reverse transcribed RNA.

Special Declaration

Before installing and operating the Gentier instrument, please read this manual carefully, observe the warnings and non-recommended functions. Also bear mind the potential scope for misuse; it is advisable to draw attention to the possible consequences.











Contraindication

This product belongs to IVD diagnostic medical device, no contraindications.



User Requirements

The Gentier instrument must only be used by laboratory professionals trained in laboratory techniques, who have carefully read this manual.

Safety Labels on Transport Package

Label	Description
	Fragile: the items inside are fragile, please handle with care.
	This Side Up: indicates the upward side of the transport package.
	Keep Dry: keep the transport package away from rain or any liquid.
	IVD Instrument: the instrument belongs to In Vitro Diagnostic equipment.
	Temperature Limit: indicates the temperature limits for the storage and transportation of package.
	Humidity Limit: indicates the humidity limits for the storage and transportation of package.
	Atmospheric Pressure Limit: indicates the atmospheric pressure limits for the storage and transportation of package.
	Max 2 Packages: it is prohibited to stack more than 2 layers for the storage and transportation of packages.
	Recycle: indicates the packaging materials are recyclable.
	CE Mark: indicates the instrument is in conformity with In Vitro Diagnostic Medical Devices Regulation (EU) 2017/746.
	Made in China: indicates that the instrument originated in China.

Safety Labels on Gentier Instrument

Label	Description
	Biohazard: indicates that a certain area of the Gentier instrument can be easily contaminated with biological reagents or samples. Reminding user to timely disinfect this area, keep necessary precautions during operation and take corresponding protective measures at the same time.
	High Temp.: indicates that a certain area of the Gentier instrument may produce high temperature. Reminding user to pay attention and be careful for burns.



Warning hands pinching: indicates that a certain part of the Gentier instrument may produce extrusion, such as automatic door. Reminding user to proceed with appropriate caution.



Warning danger: indicates that a certain part of the Gentier instrument may cause personal injury.



IVD Equipment: The Gentier instrument belongs to In Vitro Diagnostic equipment.



European Community Representative: indicates the authorized representative of this instrument in European.



CE Mark: indicates the instrument is in conformity with In Vitro Diagnostic Medical Devices Regulation (EU) 2017/746.



Serial Number: indicates the serial number of this instrument.



Manufacturer: indicates the manufacture of this instrument.



Caution: indicates the “caution” of this instrument.



Manufacture Date: indicates the manufacture date of this instrument.



Consult Instructions for Use: indicates the consult instructions for the use of this instrument.





Separate Collection for this Equipment: indicates that when the end-user wishes to discard this electrical and electronic equipment, it should not be discarded as unsorted waste but must be sent to separate collection facilities for recovery and recycling.



Made in China: indicates that the instrument originated in China.

Symbols Used in This Manual

Symbol	Description
	Caution: reminding user to pay attention to a certain operation. Operating the Gentier instrument in any manner unspecified in this manual may results in instrument damage or abnormal function.
	Reminding: providing important information regarding the Gentier instrument operation and successful application, including the information explained in further detail elsewhere in this manual.
	Prohibit: prohibiting user from a certain dangerous operation. Otherwise, it may results in instrument damage or abnormal function, even constitutes a personal injury hazard.

Conventions Used in This Manual

Convention	Meaning
Ordered list	Procedure steps must be performed follow the list order.
(Double) Click A	Click A on the application software.
Click A > B	Click B in menu A on the application software.
Press A	Press A key on the instrument system software.
<i>Italic + Bold</i>	Refers to the instructions/options of the application software.
< <i>Italic + Bold</i> >	Refers to the keys/icons of the application software.
Bold	Refers to the instructions/options of the instrument system software.
< Bold >	Refers to the keys/icons of the instrument system software.
[]	Refers to the keys on computer keyboard.
<i>italic + Blue</i>	Indicate the reference chapter.

Safety and Regulatory Compliance

The operation, maintenance and repair of Gentier instrument shall strictly follow the safety specifications listed in this section and through this manual. The design of Gentier instrument has fully considered its biological contamination protection, electrical safety protection and mechanical motion protection. Non-observance of the instructions or performing any operations not stated herein may affect the safety protection provided, and may also destroy the safety standards of design and manufacture as well as the expected application scope of the Gentier real time PCR system.

XATL Co., Ltd. will not be responsible for any possible consequence caused by either not read or violate the instructions mentioned herein.

 **Caution:** please carefully read this manual before operating the Gentier instrument. Incorrect understanding or operations may result in instrument damage or inefficiency usage, laboratory damage, even personal injury.

 **Reminding:** please pay attention to the descriptions with 'Caution', 'Reminding', 'Prohibit' symbols, and the safety labels on the instrument and transport package.

I. General Instrument Safeties and Precautions







 **Caution:** no person except the **XATL Co., Ltd** professional engineers are allowed to open the instrument, to replace any component or to debug the Gentier instrument.

 **Caution:** do not drop or damage the Gentier instrument, please handle it with care.



 **Caution:** in case of any following conditions, immediately cut off the power supply and contact the distributor or manufacturer to ask for professional engineer for processing.

- Any liquid has entered into the Gentier instrument;
- Abnormal sound or smell appears while the Gentier instrument is running;
- Gentier instrument is soaked with water or rain;
- Obvious functional changes of the Gentier instrument.











 **Prohibit:** never handling or move the Gentier instrument while it is running.

-  **Caution:** for protection against overheating hazards, the openings on the instrument are designed for ventilation. Please do not block these openings nor cover the instrument with dust cover and other materials while it is running.
-  **Caution:** Gentier instrument installation and transportation should be performed by professional engineer or under professional guidelines.
-  **Caution:** please remove the transport lock after instrument installation and reserve the transport lock for future use.
-  **Caution:** please confirm you have removed the transport lock before power on the instrument.
-  **Caution:** do not open the loading platform while the instrument is running, this may break the biological safety and electromagnetic radiation protection measures of the instrument.
-  **Caution:** do not force to place unmatched consumables into the sample block.





II. Personal Safeties and Precautions

-  **Caution:** Gentier instrument is heavy, please adopt appropriate tools and methods, or cooperate with other people to complete the lifting or moving of the instrument. Move or lift the instrument in an improper way may result in bodily injury, pain, or instrument damage.
-  **Prohibit:** never touch the plug, the power cord or the power switch with wet hands.
-  **High Temp.:** do not directly touch the sample block and the hot lid while the instrument is still running, they may generate enough heat to cause serious burns. Please wait the sample block to return to idle temperature before opening the loading platform.





III. Electrical Safeties and Precautions

-  **Prohibit:** the voltage of Gentier instrument can cause harms to human body, please cut off the power supply before opening the instrument shell, and it is prohibited to replace any part of the instrument while it is electrified.
-  **Caution:** Gentier instrument should be properly grounded, any damage of the internal or external grounding path may cause dangerous.
-  **Caution:** in case of electric leakage, immediately unplug the Gentier instrument and stop using.
-  **Caution:** please unplug the power cord before moving the Gentier instrument.
-  **Reminding:** under normal circumstances, please use the instrument attached power cord. If the original power cord is destroyed, please substitute it with an equal one.
-  **Caution:** for protection against electric shock hazards, the Gentier instrument must be grounded properly. The power cord provided is a standard three-pin plug, please plug it into an appropriate three-wire grounded receptacle for operation safety.
-  **Caution:** the power grid environment of Gentier instrument must have ground wire.
-  **Caution:** please check the power connection carefully. Hold the power plug when you plug the power cord and make sure the power plug is perfectly inserted into the socket, do not pull the power cord to pull out the plug.
-  **Caution:** please keep the power cord away from heater or other high temperature objects. Please do not put anything on the power cord and keep it away from places where people move around.
-  **Caution:** the fuse tube type of the Gentier instrument is F10AH250V, located in the fuse tube box near the power outlet at the rear of the instrument.
-  **Caution:** use improper fuse tube may lead to circuit system damage. Please check and make sure that the fuse tube has been properly installed before switch on the instrument. If the fuse fails, please replace it with the same type of fuse tube.

IV. Environmental Safeties and Precautions

-  **Caution:** Gentier instrument is for indoor use only, the room should be well ventilated and without corrosive gas.
-  **Prohibit:** never run the Gentier instrument in places that have or may have flammable and explosive gas.
-  **Prohibit:** spraying liquid on electrical parts may cause a short circuit and result in fire, do not use sprays in vicinity of the Gentier instrument.
-  **Reminding:** the working environment temperature of Gentier instrument should be between 10°C~30°C, and the relative humidity should be between 20%~85%.
-  **Reminding:** the working environment of the Gentier instrument should be under normal atmosphere (the altitude should below 2000m).

V. Biological Safety and Precautions

-  **Biohazard:** the sample objects of the Gentier instrument are nucleic acids, please consider all samples are with potential biohazard, and please take applicable safety protection measures and wear appropriate protective goggles, clothing and gloves while processing the samples.
-  **Biohazard:** in case of any liquid overflows during the operation, please immediately disinfect the contaminated area with appropriate detergent to avoid the spreading of contaminant, prevent the laboratory or instrument from biohazards.
-  **Biohazard:** please comply with the local or national applicable regulations to complete the disposal of waste samples and contaminated materials.
-  **Biohazard:** user should consider the abandoned Gentier instrument as biological contaminated material and comply with the local or national applicable regulations to complete the instrument disposal. Before disposal or recycle the instrument, please completely clean and disinfect the instrument.
-  **Biohazard:** user should only use reagents and consumables that are within their expiration date.

Content

A. OVERVIEW	2
1. APPLICATION FIELDS	2
2. PRODUCT CONSTITUTE AND INSTRUMENT STRUCTURE	2
2.1 <i>Product Constitute</i>	2
2.2 <i>Instrument Structure</i>	2
3. PRODUCT INTRODUCTION	3
3.1 <i>Instrument Parameters and Characters</i>	3
3.2 <i>Software Characters</i>	8
3.3 <i>Reagent Specifications</i>	9
3.4 <i>Consumable Specifications</i>	9
B. GENTIER INSTRUMENT INSTALLATION	10
1. UNPACKING INSTRUCTIONS	10
2. WORKING ENVIRONMENTAL REQUIREMENTS	12
2.1 <i>Instrument Space Requirements</i>	12
2.2 <i>Instrument Power Requirements</i>	13
3. INSTRUMENT INSTALLATION	14
3.1 <i>Remove Transport Lock</i>	14
3.2 <i>External Device Connection</i>	16
3.3 <i>Application Software Installation</i>	16
3.4 <i>Unlock the Gentier Instrument</i>	17
3.5 <i>Computer Network Setting</i>	19
C. THE PREPARATION BEFORE EXPERIMENT	21
1. INSTRUMENT SELF INSPECTION	21
2. REAGENT PREPARATION	21
3. INSTRUMENT LOADING	21
D. APPLICATION SOFTWARE OPERATION	22
1. STARTUP APPLICATION SOFTWARE	22
2. QUICK START BAR	23
3. MAIN INTERFACE	27
3.1 <i>Menu Bar</i>	28
3.2 <i>Tool Bar</i>	49
3.3 <i>Operation Area</i>	50

E. INSTRUMENT SOFTWARE OPERATION	107
1. BOOT SCREEN & MAIN MENU INTERFACE	107
2. INSTRUMENT SOFTWARE OPERATION AREA	109
2.1 <i>Experiment File</i>	109
2.2 <i>Run Setting</i>	112
2.3 <i>Run Monitoring</i>	125
2.4 <i>General Setting</i>	128
F. INSTRUMENT CLEANING AND MAINTENANCE	134
1. INSTRUMENT CLEANING OPERATION INSTRUCTIONS	134
1.1 <i>Clean Instrument Shell</i>	135
1.2 <i>Clean Touch Screen</i>	135
1.3 <i>Clean Loading Platform and Sample Block</i>	135
2. INSTRUMENT MAINTENANCE OPERATION INSTRUCTIONS.....	136
2.1 <i>Maintain Sufficient Air Flow</i>	136
2.2 <i>Maintain Stable Power Supply</i>	136
2.3 <i>Maintain Instrument Cleanliness</i>	136
2.4 <i>Replace Fuse Tube</i>	137
2.5 <i>Replace Dust Filter Foam</i>	137
3. TRANSPORTATION OR RETURN TO FACTORY	138
3.1 <i>Instrument Disinfection</i>	138
3.2 <i>Gentier Instrument Transportation Locking</i>	139
3.3 <i>Product Packaging</i>	142
4. TROUBLESHOOTING	144
G. CONTACT INFORMATION	146
APPENDIX 1 - PRODUCT ACCESSORIES LIST	147

User Manual Modification Points between Versions				
SN	Modification Point	Current Version	Page	Date
1	Manual Version; Modification Time	V2.8	II	01.07.2024
2	User Manual Modification Points between Versions		1	
3	Description of Accuracy of Thermo Control, Uniformity of Thermo Control and Consistency of Thermo Control		5	
4	Application Software Installation		16	
5	Reminding added		109	
<p>Note: This modification points are only for client reference. If you need modification details, please contact <i>XATL Co., Ltd</i> after-sale service referring to "G. Contact Information".</p>				

A. Overview

1. Application Fields

The Gentier real-time PCR system is intended for performing rapid, accurate polymerase chain reaction (PCR), meanwhile real-time measuring the nucleic acid signals from DNA-binding fluorescent dyes or labeled probes and converts them to comparative quantitative readouts of DNA or reverse transcribed RNA.

The Gentier real-time PCR system can be used in medical institution laboratories and clinical laboratories for infectious pathogens (such as viruses, bacteria, mycoplasma, chlamydia, etc.) detection; or multiple tumor marker tests of neoplastic diseases, etc. For scientific research, it could be used for the fluorescence quantitative or qualitative analysis of genetic materials DNA/RNA in fields of immunology, molecular biology, forensic science, genetics, archeology, zoology, phytology, etc.

2. Product Constitute and Instrument Structure

2.1 Product Constitute

The Gentier real-time PCR system is mainly consisted of control system, power system, temperature control system, detection system, man-machine interface system and instrument shell, etc.

Among them, the temperature control system includes Peltier heating module, sample block and hot lid, etc.; the detection system includes LED excitation light source, photodiodes and light filter, etc.; the man-machine interface system includes data acquisition and analysis software, which is mainly responsible for real-time data collection, fluorescence diagram formation, data processing and diagram analysis, in order to quantify or characterize the target nucleic acid and obtain other test report information, etc.

2.2 Instrument Structure

The structure of Gentier instrument is shown in figure A-1.

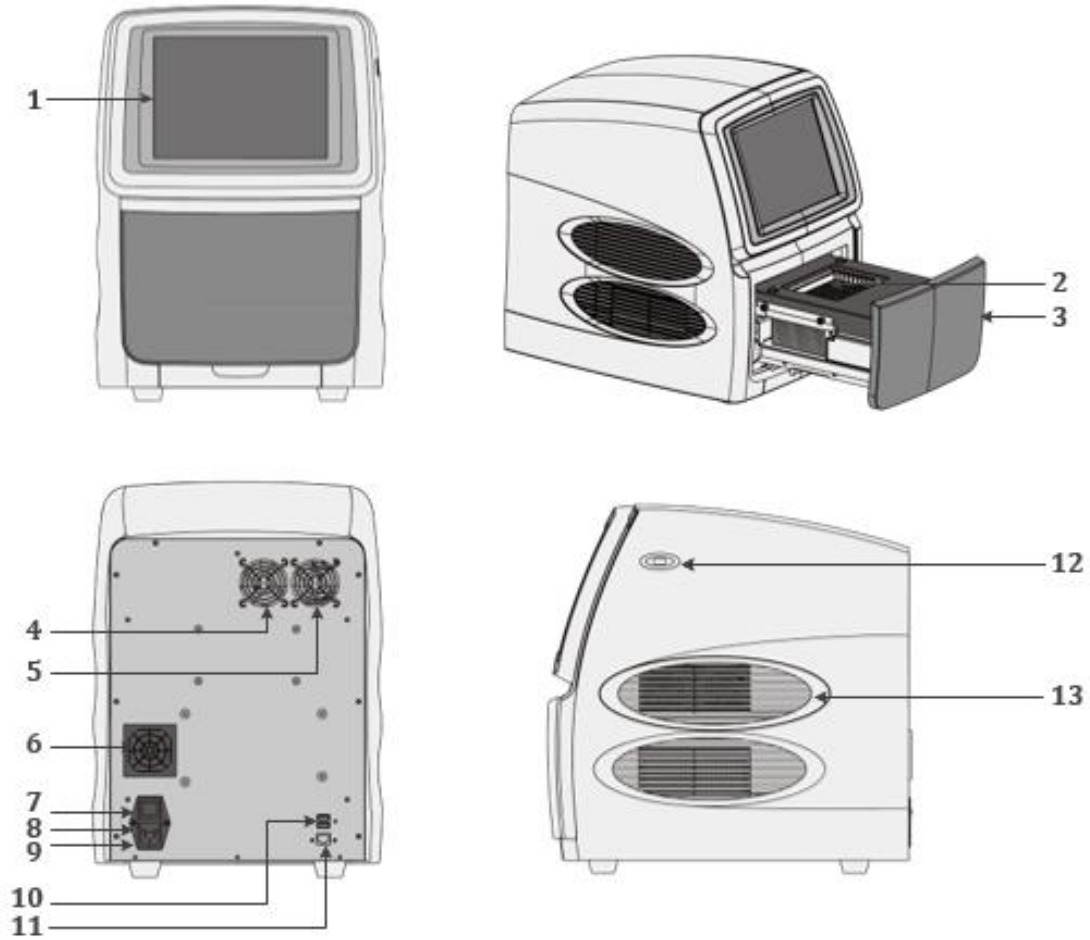

Figure A-1. Gentier Instrument Structure

1. Touch Screen

2. Sample Block

3. Loading Platform

4&5. Cooling Fan

6. Air Vent

7. Power Switch

8. Fuse Tube Box

9. Power Socket

10&12. USB Interface

11. Internet Access

13. Removable Air Vent Cover

3. Product Introduction

3.1 Instrument Parameters and Characters

3.1.1 Instrument General Parameters

► **Instrument Specification:**

Dimension: 475mm(L) × 355mm (W) × 484mm (H);

Weight: 30kg;

▶ **Package Specification:**

Dimension: 670mm(L) × 580mm (W) × 580mm (H);

Weight: 38kg;

▶ **Power Specification:**

Voltage: AC 100~240V;

Frequency: 50/60Hz;

Rated power: 900VA;

Overvoltage category: II;

▶ **Power Cord:**

less than 1.5 meters;

▶ **Network Cable:**

Cat 5e FTP cable with length less than 3 meters;

▶ **Communication Specification:**

Network port: TCP/IP protocol;

Ethernet connection;

USB 2.0 interface;



Reminding: Connected to IEC/EN 60950-1 approved computer host and mouse.

▶ **Application Environment:**

Temperature: 10°C ~30°C;

Relative humidity: 20%~85%, non-condensing;

Altitude/pressure: 0m - 2000m, 85.0kPa~106.0kPa;

▶ **Storage and Transportation Environment:**

Temperature: -20°C~55°C, with transport package;

Relative humidity: 0%~93%, non-condensing;

Altitude/pressure: 0m - 10000m, 26.4kPa~106.0kPa;

▶ **Running Noise:**

The maximum noise while instrument running does not exceed 65 decibel.

- ▶ **Pollution Degree:** 2

3.1.2 Instrument Technical Parameters

Thermal Parameters

- ▶ **Accuracy of Thermo Control:** $\leq 0.1^{\circ}\text{C}$;
- ▶ **Uniformity of Thermo Control:** $\pm 0.1^{\circ}\text{C}$;
- ▶ **Consistency of Thermo Control:** $\leq 0.1^{\circ}\text{C}$;
- ▶ **Average Heating Ramp:** $\geq 4.5^{\circ}\text{C/s}$
- ▶ **Max Heating Ramp:** $\geq 6.1^{\circ}\text{C/s}$
- ▶ **Average Cooling Ramp:** $\geq 2.8^{\circ}\text{C/s}$
- ▶ **Max Cooling Ramp:** $\geq 5.0^{\circ}\text{C/s}$

Optical Parameters

- ▶ **Excitation Light Source:** LED light sources;
- ▶ **Detect System:** photodiodes;

▶ Channel:	Dyes	Instrument Models		
		96E	96T	96R
1	FAM, SYBR Green I, LC Green, Eva Green, SYTO 9	✓	✓	✓
2	HEX, TET, VIC, JOE	✓	✓	✓
3	Texas Red, ROX	✓	✓	✓
4	Cy5	✓	✓	✓
5	Alexa Fluor 680	✓	✓	✗
6	(FRET probe) ^① or (Tamra, Cy3, NED) ^②	①	②	✗

- ⚠ **Reminding:** 96E & 96T two instrument models possess 6 channels, but the suitable dyes are different.
- ⚠ **Reminding:** 96R instrument model possesses 4 channels.
- ⚠ **Reminding:** the channel 6 of 96E instrument model is for FRET probe, which takes the report group of channel 1 as the energy donor and the report group of channel 3 as the energy receptor.

Detective Parameters

- ▶ **Throughputs:** simultaneously detect 96 samples.
 - ▶ **Repeatability:** $CV \leq 0.5\%$.
 - ▶ **Linear Correlation:** $|r| \geq 0.999$, within the scope of no less than five magnitudes concentration gradients.
-

Man-machine Interactive System Parameters

- ▶ **Touch Screen:** with built-in 10.4' inches color touch screen, providing more simple operation. The instrument can run alone without the control computer. The stand-alone running saves more space and energy.
- ▶ **USB interface:** the USB interface of Gentier instrument is only used to connect USB disk.
 - ⊘ **Prohibit:** the USB interface of Gentier instrument can not be used for charging.
 - ⊘ **Prohibit:** do not connect external devices via USB interface while the instrument is running.
 - ⚠ **Reminding:** the connected external devices, electric circuit connected shall pass the security certification to ensure that the Gentier instrument will not be damaged.
 - ⚠ **Reminding:** the rated output voltage of the USB interface is $5 \pm 5\%$;
 - ⚠ **Reminding:** the rated output voltage of the USB interface is 500mA.
 - ⚠ **Reminding:** please format the USB disk as FAT32 format before connect it to the Gentier instrument.
 - ⚠ **Reminding:** please make sure that there is at least 1GB space left in the USB disk before connect it to the Gentier instrument.

- ▶ **Main Control Computer:** the recommend configurations of main control computer are listed as below.
 - Computer Processors: quad core CPU;
 - Internal Storage: 8GB;
 - Hard Disk: 500GB;
 - Network Card: 10M/100M adaptive network card;
 - Display Resolution: 1440 x 900 or higher;
 - Operating System: Windows 7_ 64bit/32bit, Windows 10 _ 64bit/32bit;
 - Necessary Software: Office/Excel 2010.

 **Caution:** the main control computer of the Gentier instrument is not designed for online use, connect it to internet may cause risks of computer virus infection or hacker attacks. **XATL Co., Ltd.** will not be responsible for any damages caused by.

 **Caution:** it is not recommended to install other software on the main control computer of the Gentier instrument. Otherwise, there may be potential risks of software module conflict, and may also influences the results reliability.

 **Caution:** **XATL Co., Ltd.** will not provide anti-virus software. Therefore, if necessary, please take preventive measures to prevent the main control computer from virus.

3.1.3 Instrument Characters

- ▶ **Touch Screen Operation:** Gentier instrument possesses a built-in 10.4-inch colored touch screen and is very easy for operation. It can run independently from the computer;
- ▶ **Independent Temperature Control:** Gentier instrument adopts independent temperature control technology and high repeatability temperature zone. Truly realize the optimization of PCR;
- ▶ **Loading Platform:** the Gentier instrument possesses loading platform that can be ejected, very convenient for sample loading and reduce the experiment environment contamination.
- ▶ **Concealed Hot Lid:** Gentier instrument possesses a constant pressure, thermostatic concealed hot lid. This unique design could avoid the possible contact between user and the hot lid, therefore ensure the operation safety;

- ▶ **Power-off Protection:** Gentier instrument possesses instantaneous power-off protection function which can protect all configuration settings in case of power off and the interrupted experiment can continue after power on.
- ▶ **Multiple PCR Step Modes:** Gentier instrument provides multiple PCR step modes, such as touchdown step, long step, gradient step, melting step and so on.
- ▶ **Network Control:** one computer can connect with 10 Gentier instruments at the same time, user can remote control the experiment and truly realize the network centralized control.
- ▶ **Remote Running:** user could edit experiment settings on control computer and command the connected Gentier instrument, truly realize the remote running control and real-time monitoring.
- ▶ **Lis System:** the Gentier instrument can be connected to hospital Lis system.

3.2 Software Characters

- ▶ **Software Interface:** wizard-style interface, intuitive layout and program setting, very easy for operation.
- ▶ **Software Language:** with switchable multiple languages. Default languages are Chinese and English.
- ▶ **Multiple Functions:** the software possesses multiple analysis functions that can adapt to a variety of experimental requirements. Such as absolute quantification analysis, relative quantification analysis, melting curve analysis, high resolution melting (HRM) analysis, genotyping analysis, end point fluorescence analysis, etc.
- ▶ **Data Transmission:** data can be transmitted between the Gentier instrument and the control computer. In the process of experiment, Gentier instrument will real-time transmitting the experiment data to the control computer.
- ▶ **Data Storage:** the Gentier instrument can store 1000 experiment setting /experiment data files at most.
- ▶ **Program Setting:** each Stage can contain 99 steps, and the maximum cycle number is 99. User can set the program for low temperature long-term preservation after the experiment.
- ▶ **Report Template Design:** the unique report function is designed by **XATL Co., Ltd.** for user to customize their own report form, more suitable for the personal needs of all user.

3.3 Reagent Specifications

- ▶ **PCR Reagent:** open platform for all qualitative and quantitative PCR reagent.
- ▶ **Dye:** FAM/SYBR Green I/LC Green/Eva Green/SYTO 9, HEX/TET/VIC/JOE, Texas Red/ROX, Cy5, Alexa Fluor 680, Tamra/Cy3/NED, etc.
- ▶  **Biohazard:** user should only use reagents and consumables within their expiration date.

3.4 Consumable Specifications

- ▶ 0.2mL single PCR tube (clear, white or frosted), clear tube cap.
- ▶ 0.2 mL 8-strip PCR tube (clear, white or frosted), clear tube cap.
- ▶ 0.2 mL 96-well no skirt PCR plate (clear, white or frosted).
- ▶  **Reminding:** When there is only few sample size for experiment run, it is recommended that user is supposed to leave an empty PCR tube in each corner of sample block for supporting the hot lid to avoid tube deformation occurrence because of uneven pressure from hot lid or PCR tube heating up.

B. Gentier Instrument Installation

1. Unpacking Instructions

The Gentier transport package is as shown in figure B-1. The Gentier instrument and its accessories are well preserved in a carton case. In order to prevent the collision and oscillation during transportation, the Gentier instrument is sealed with plastic bag and well supported by protective foams.

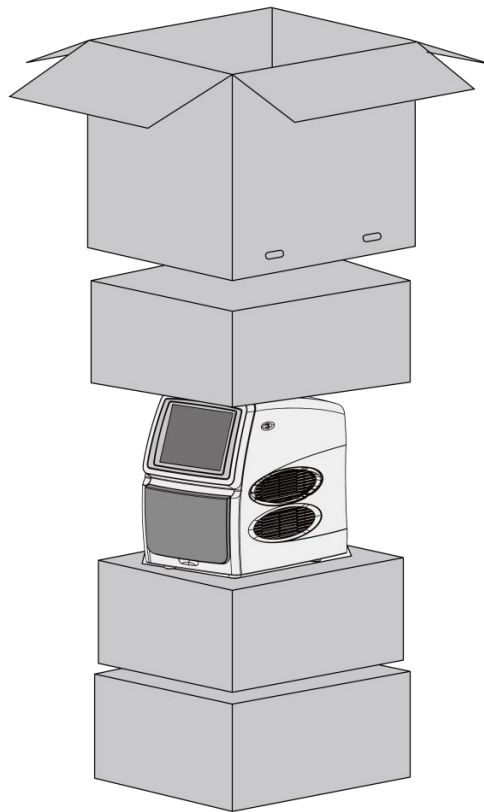
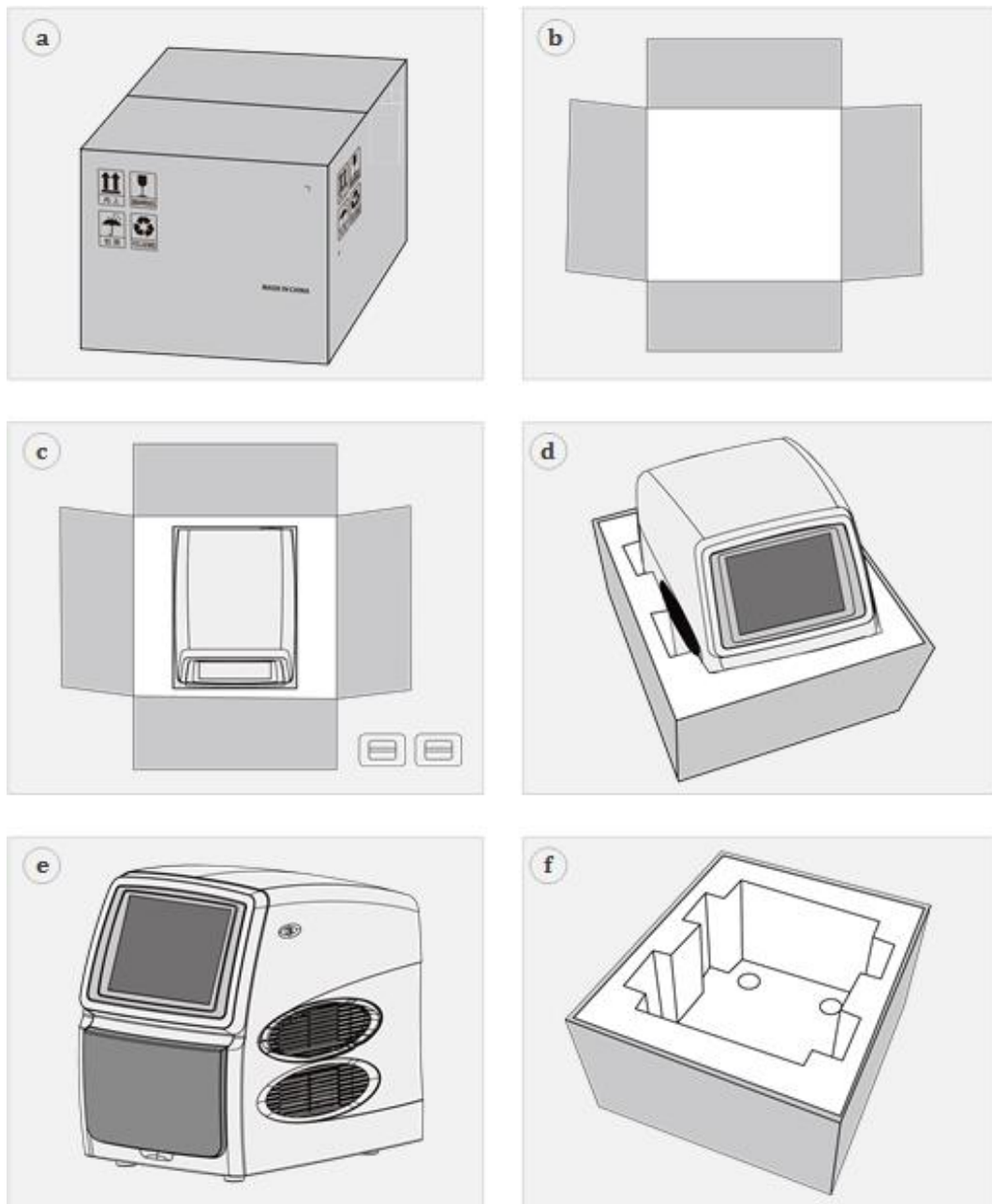



Figure B-1. Package Details

The unpacking of the Gentier transport package mainly includes 3 steps, as shown in figure B-2. The specific operation method is as follow.

- 1st Step:** please cut off the packing belt and unseal the transport package, as shown in figure B-2a. Then remove the top protective foam, as shown in figure B-2b.
- 2nd Step:** please remove the four plastic buckles on both sides of the package, as shown in figure B-2c. Grasp the handles and remove the top half carton, as shown in figure B-2d.
- 3rd Step:** please hold the Gentier instrument on both sides, take it out of the carton and place it on steady plane, shown in figure B-2e, B-2f.



- ❗ **Reminding:** in order to prevent the formation of condensation water, please do not open the transport package until it reaches the room temperature.
- ❗ **Reminding:** please check the package integrity before open it. In case there is any damage, collision or water mark, please contact the transport department or our company.
- ❗ **Reminding:** please check the instrument and accessories according to the packing list and ensure that all components are present and intact, report any missing items to **XATL Co., Ltd.**

 **Reminding:** please fill in the relevant content on installation information feedback table after acceptance, and send it back to our company for document and warranty.

 **Caution:** please reserve the original packing materials for future use. The transport package of Gentier instrument is designed to reduce the instrument damage and ensure its transportation safety. Adopt other packaging materials will break the warranty, and **XATL Co., Ltd.** will not be responsible for damages as consequences of improper packaging that incurred during the transportation. Please also keep instrument related documents provided by our company for future use too.

2. Working Environmental Requirements

2.1 Instrument Space Requirements

- 1) The Gentier instrument is for indoor use only. It should be placed in the room with low humidity (between 20% ~85%RH) and appropriate temperature (between 10°C~30°C). The room should be well ventilated and without corrosive gas.
- 2) The Gentier instrument should be placed on steady lab work bench and leave enough space for placing the attachments, cables and reagent bottles, etc.
- 3) Please keep the Gentier instrument away from heat sources (directly sunshine, heater, stoves) and water sources (such as water pool, water tube etc.).
- 4) The working environment of Gentier instrument should be without electromagnetic interference, vibration and high frequency wave electrical equipment.
- 5) For single Gentier instrument running, the distance between adjacent objects and the surrounding ventilation openings shall be no less than 30cm. In case that multiple instruments are running at same time, the distance between adjacent instruments should not be less than 80cm.
- 6) For protection against overheating hazards, the openings on the Gentier instrument are designed for ventilation. Please do not block or cover these ventilation openings while it is running.
- 7) Do not place the Gentier instrument on soft surface, the instrument base may sink into the soft surface and block up the air inlet beneath.
- 8) Do not place the Gentier instrument close to the wall or pile up other goods at the rear of the instrument, this may affect heat dissipation.
- 9) Do not place the Gentier instrument in such a way that is difficult for disconnection.

2.2 Instrument Power Requirements

- 1) The power grid environment of Gentier instrument should possess ground wire and the instrument should be properly grounded.
- 2) Please ensure the power strip of Gentier instrument has 3~4 three-phase plugs in order to meet the demands for the instrument, control computer and printer.
- 3) The power specifications of Gentier instrument are listed in *"A3.1 Instrument Parameters and Characters - 3.1.1 Instrument General Parameters"*, use improper power may damage the circuit system and cause fire, it is recommended to use UPS (Uninterruptible Power Supply).



Reminding: before connecting the AC power supply, please ensure the consistent of the Gentier instrument required voltage and the power supply voltage (allowable deviation $\pm 10\%$). And make sure that the rated load of receptacle is no less than the requirement of the Gentier instrument.



Reminding: if the power supply system of the Gentier instrument working environment is unstable, please do not connect other electrical equipment at the same power circuit, and it is required to equip with over 900VA AC regulated power supply.



Prohibit: spraying liquid on electrical parts may cause a short circuit and result in fire, do not use sprays in vicinity of the instrument.



Caution: do not put anything on the power cord and keep it away from places where people move around. Hold the power plug when you plug the power cord and make sure the power plug is perfectly inserted into the socket, do not pull the power cord to pull out the plug.



Reminding: under normal circumstances, please use the instrument attached power cord.



Reminding: please check the power cord periodically, substitute with an equal one in case it is found to be damaged.

3. Instrument Installation

3.1 Remove Transport Lock

After unpacking, please do not directly power on the Gentier instrument, it is fixed by transport lock during transportation. Please remove the transport lock in accordance with the instructions as below before running the Gentier instrument.

1st Step: there is a removable air vent cover located on the right side of the instrument shell, as shown in figure B-3a. Please use appropriate tool to pry off and remove the removable air vent cover, as shown in figure B-3b.

2nd Step: the transport lock screw is fixed upon two cooling fans, as shown in figure B-3c. Please use screwdriver to remove the fixed transport lock screw, as shown in figure B-3d, e.

3rd Step: after unscrewing the transport lock screw, please well reserve it for future use. Then install the air vent cover back to the original place on the instrument shell, as shown in figure B-3f. At this point, the remove of transport lock is completed

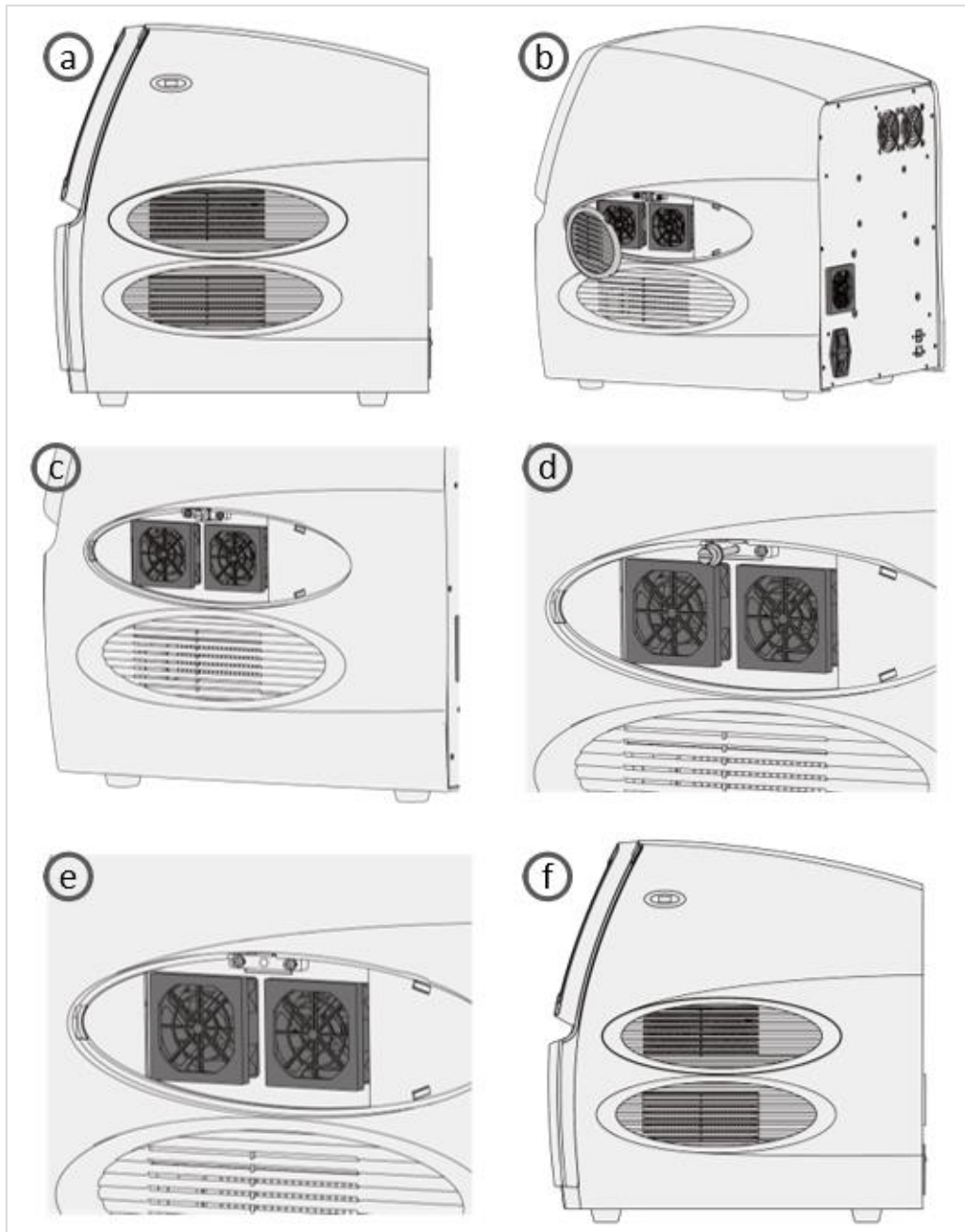





Figure B-3. Remove Transport Lock

-  **Caution:** unless it is noted in this manual, please do not loosen or remove any internal and external screws or other parts, otherwise it will break the instrument warranty and result in instrument misalignment.
-  **Caution:** Gentier instrument should be installed by professional engineer or under the guidance of professional engineer.

3.2 External Device Connection

Please plug the corresponding power cords of Gentier instrument, control computer and printer to the power supply respectively. Then please confirm the connections of external devices, such as the control computer, display, keypad, mouse and printer, etc.

 **Reminding:** under normal circumstances, please use the instrument attached power cord. If the original power cord is destroyed, please substitute it with an equal one.

 **Caution:** Gentier instrument should be properly grounded, any damage of the internal or external grounding path may cause dangerous.

 **Reminding:** the connected external devices through USB interface shall pass the security certification to ensure that that with the Gentier instrument will not be damaged.

3.3 Application Software Installation

The application software is required on the control computer for commanding the Gentier instrument and analyzing the experimental data. Before starting up the application software, user should install it on the control computer. The specific operations are as follow:

1st step: switch on the control computer, open the installation package of the Gentier application software on the control computer.

2nd step: the application software installation interface will automatically pop up, please follow the prompt to install the software.

3rd step: double-click the  icon on the desktop to startup the Gentier application software.

3.4 Unlock the Gentier Instrument

At the first time Gentier instrument startup, the instrument system software will prompt user to unlock it and the specific operation steps are as follows:

1st step: the instrument system software will prompt user to confirm that the transport lock has been removed, as shown in figure B-4.

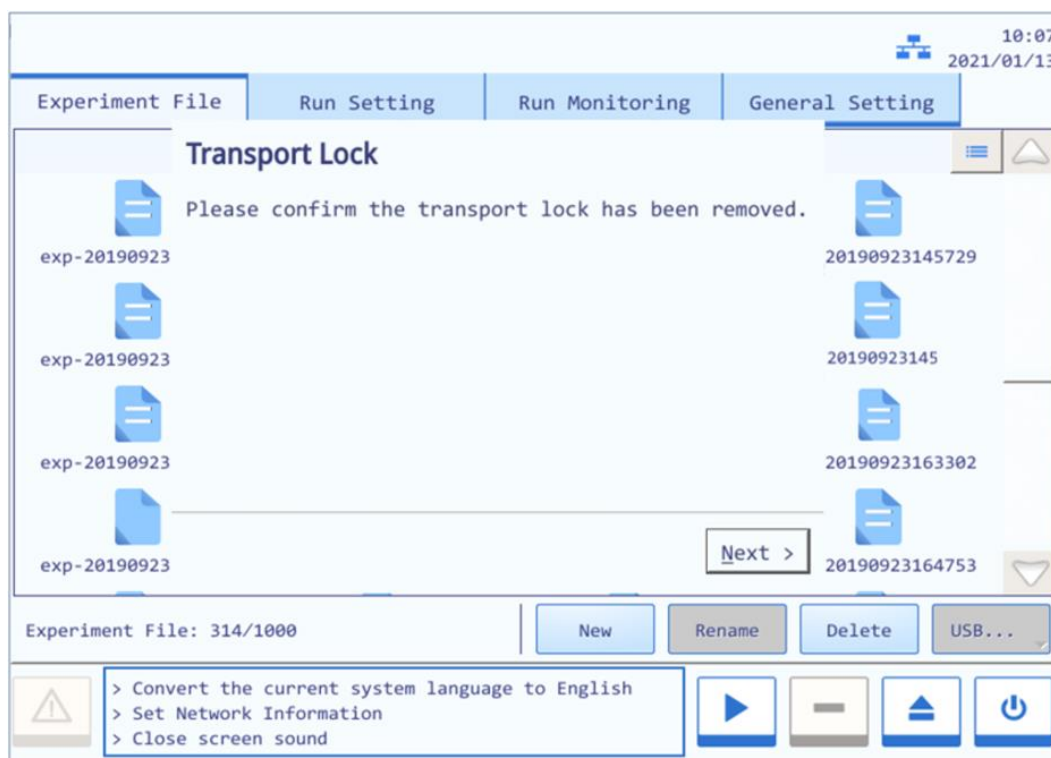

Figure B-4. Instrument System Software - Unlock the Gentier Instrument (1)

2nd step: If the transport lock has been removed, press < **Next** > and the instrument system software interface will be as shown in figure B-5.

3rd step: press < **Unlock** > and the mechanical parts of the Gentier instrument will automatically move and reset. After the instrument is reset, press < **Next** > and the instrument system software will prompt user the instrument has been unlocked, as shown in figure B-6.

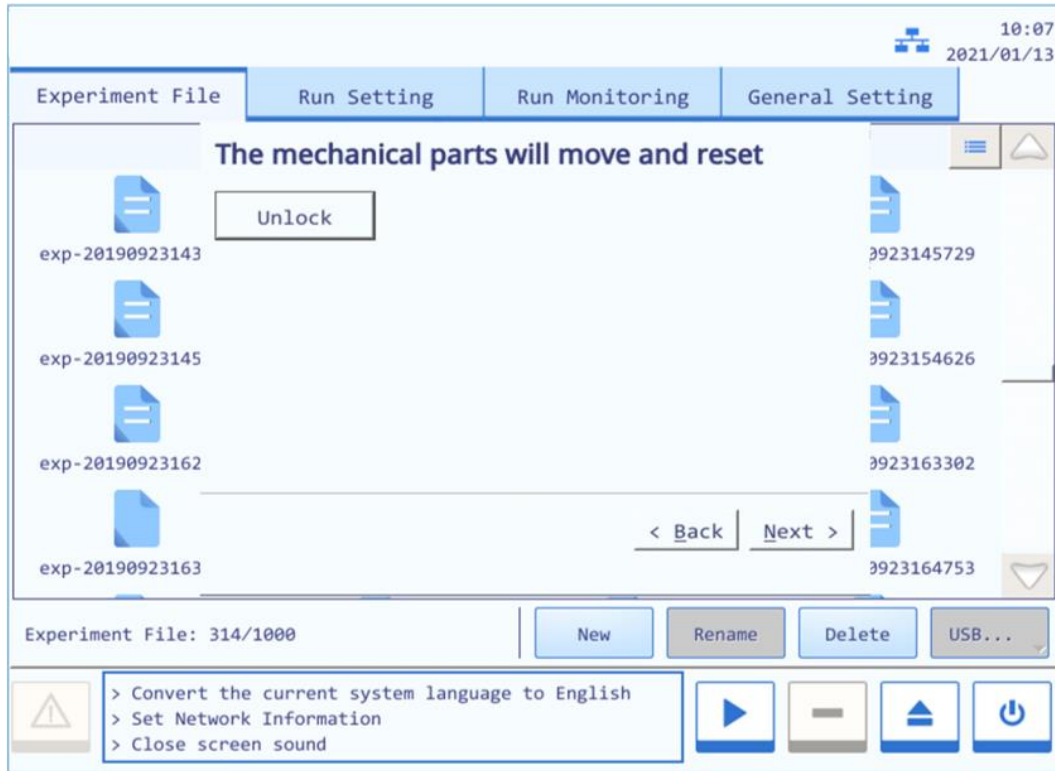

Figure B-5. Instrument System Software - Unlock the Gentier Instrument (2)

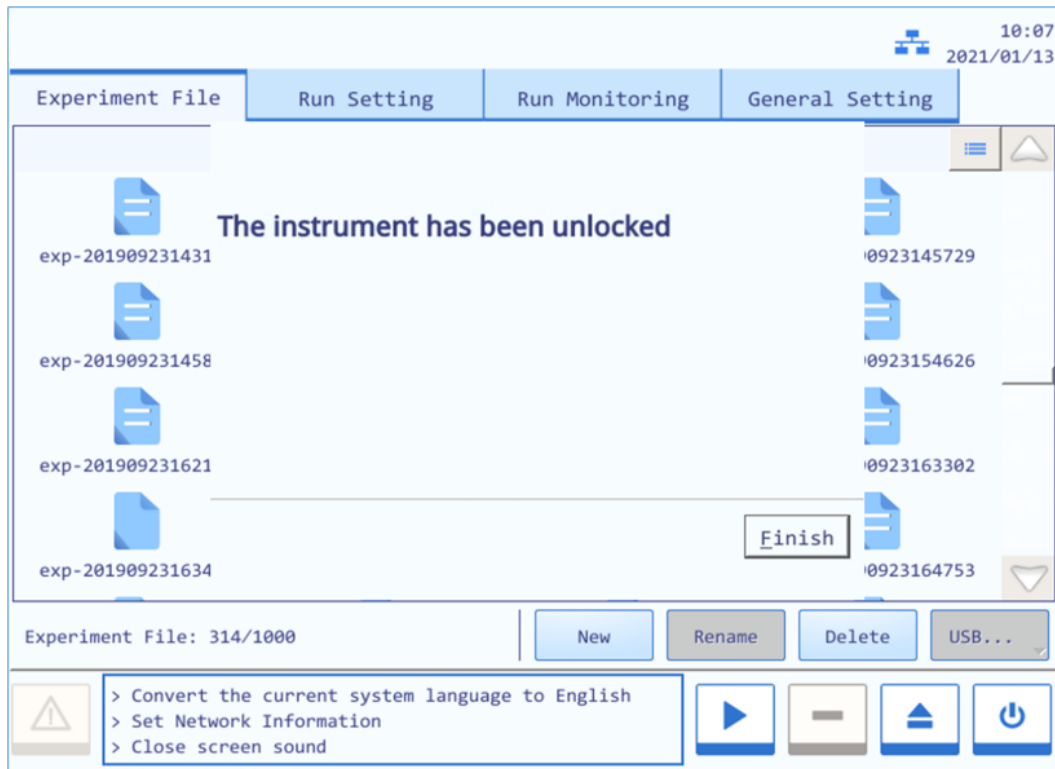

Figure B-6. Instrument System Software - Unlock Gentier Instrument (3)

3.5 Computer Network Setting

The network address of the control computer should be set according to the default network information of the Gentier instrument. So the control computer can connect the identifiable Gentier instruments within LAN.

1st step: please first check the network information of Gentier instrument, which is displayed on the network information window of the instrument software, as shown in figure B-7a. For detailed operation, please refer to [E-2.4 General Settings - 2.4.2 Configuration Sub-tab - Network Information](#).

2nd step: please open **Control Panel > Network and Sharing Center > Local Area Connection > Properties > Internet Protocol Version 4 (TCP/IPv4)** on the control computer, as shown in figure B-7b.

3rd step: set the IP address, subnet mask and default gateway of control computer according to the default network information of the Gentier instrument.

- **IP address:** the first 3 bytes of control computer IP address should be identical to the Gentier instrument IP address while the last one should be different to the instrument's.
- **Subnet mask:** the control computer subnet mask should be identical to the Gentier instrument subnet mask.
- **Default gateway:** the control computer default gateway should be identical to the Gentier instrument default gateway.

4th step: click [**OK**] to confirm the control computer network setting.

5th step: after the control computer network setting, user can connect the identifiable Gentier instruments within LAN, for detailed operations, please refer to [D-3.1 Menu Bar - Tool \(T\) submenu- Instrument Management](#).

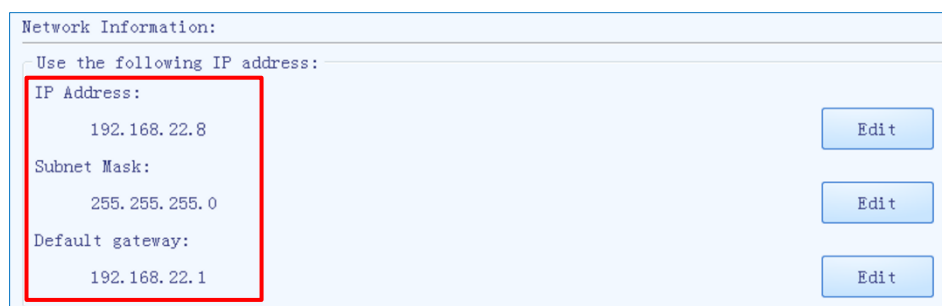

Figure B-7a. Network Information Window - Default Network Information

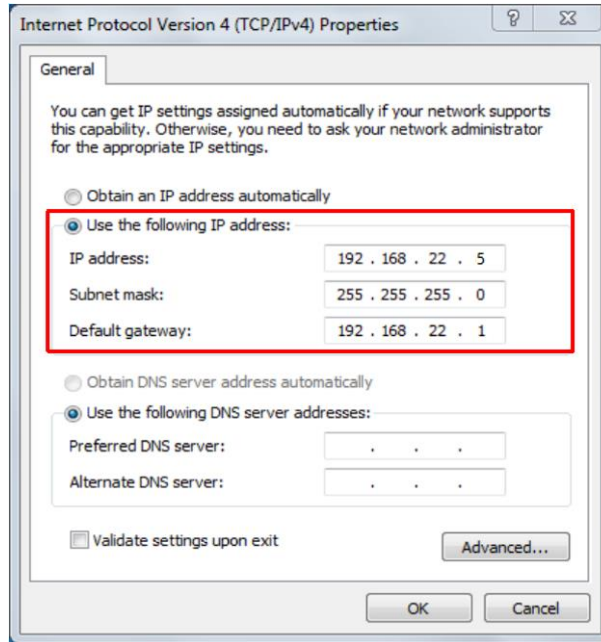

Figure B-7b. Control Computer Network Setting

C. The Preparation before Experiment

1. Instrument Self Inspection

The Gentier instrument possesses self-inspection function, it is recommended conduct the self-inspection before running any experiment, to ensure that it can work normally.

1st Step: switch on the power switch of Gentier instrument.

2nd Step: Gentier instrument will automatically conduct the self-inspection after power on, which will inspect instrument version, whether electric system is in normal working state, whether power supply is normal and initialize the motor positions, etc.

3rd Step: after the self-inspection, the Gentier instrument will enter the standby state.

 **Caution:** before power on the Gentier instrument, please ensure:

- The transport lock of the Gentier instrument is removed.
- The external devices of the Gentier instrument are properly connected.
- The power supply of Gentier instrument is properly connected.

 **Caution:** in case the Gentier instrument fails to pass the self-inspection, do not slap or shake it, please contact the distributor or **XATL Co., Ltd.**

2. Reagent Preparation

1st Step: please follow the operation instructions of PCR kit to prepare the PCR reagent.

2nd Step: please add the sample and PCR reagent into the suitable consumables, then cap or seal the consumables.

3. Instrument Loading

1st Step: press <  **Open/Close** > function key on the touch screen, the instrument will eject the loading platform and the sample block will be present in front of the user.

2nd Step: place the consumables that contain the sample and PCR reagent mixture into the sample block and press the <  **Open/Close** > function key again to withdraw the loading platform.

3rd Step select or edit an experiment program and then start running.

D. Application Software Operation

The software operation instructions of the Gentier real-time PCR system mainly including the introduction of basic software functions and operation descriptions, such as user account management, new experiment creation and edition, real-time monitoring and experiment data analysis, etc. Among all the 96 throughputs Gentier instrument models, Gentier 96E instrument model possesses the most comprehensive functions. Therefore, the Gentier 96E instrument model is taken as an example for the function and operation description in this user manual, the instrument and software interface figures presented herein are all based on Gentier 96E instrument model. For different Gentier instrument models, the software interface will display the corresponding features and instrument model names, this user manual will specify the differences of software interfaces or functions.

1. Startup Application Software

After successfully installing the application software on the control computer, user can double click the  icon on the desktop or click the application software file on the start menu to startup the Gentier real-time PCR application software. The Welcome screen of the application software is as shown in Figure D-1.



Figure D-1. Welcome Screen of Gentier Real-time PCR Application Software

After starting the application software, the Welcome screen will automatically switch to the startup interface and pop up quick start bar on this interface, as shown in figure D-2.

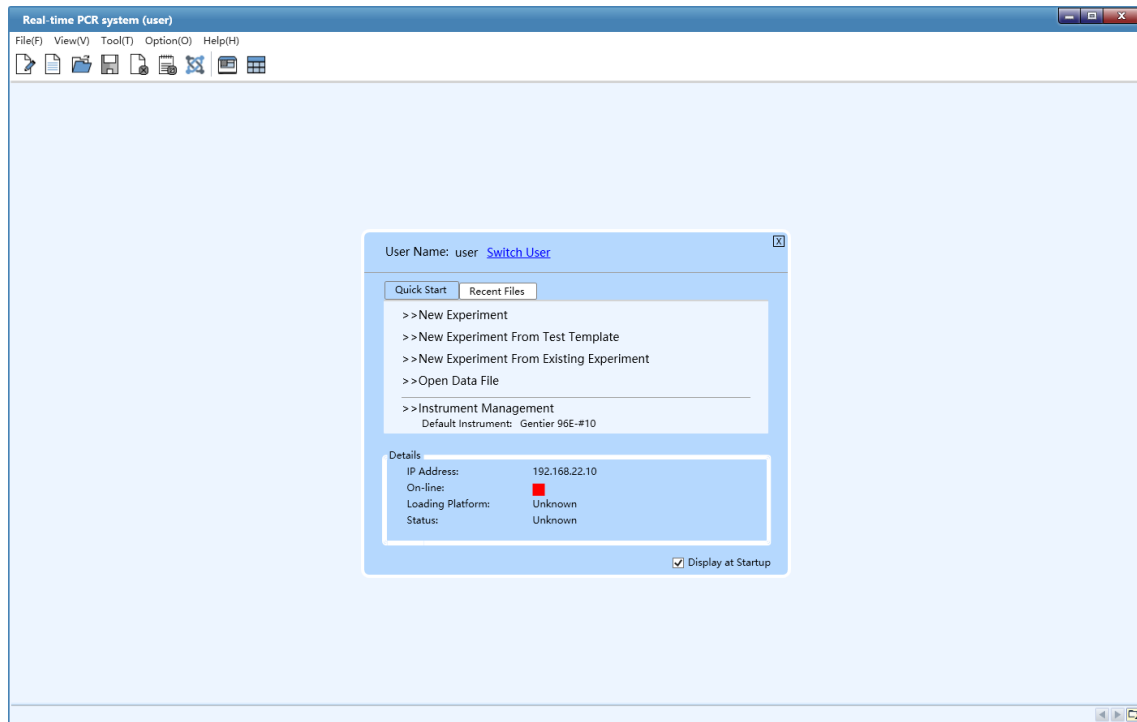

Figure D-2. Startup Interface Of Application Software

2. Quick Start Bar

The quick start bar of application software is as shown in figure D-2.1. At this interface, user can login, create new experiments, open data file, set default instrument, view instrument information and conduct other operations.

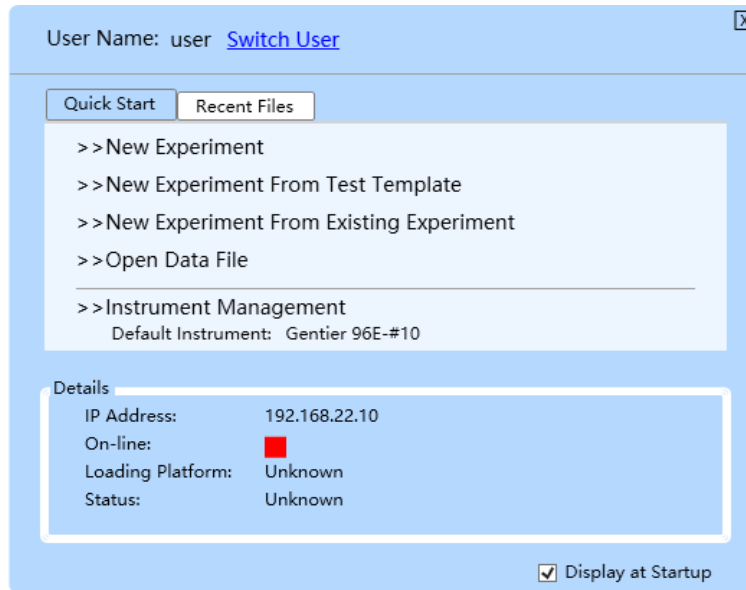

Figure D-2.1 Quick Start Bar

Quick Start Bar Introduction & Parameter Descriptions

- ▶ The current **User Name** is displayed on the top of quick start bar and user can click < **Switch User** > to change the current user account.
- **Login:** user can click < **Switch User** > and enter the registered account name in the input box; or select a registered account name in the drop-down menu, and then click < **Login** > to log in as the current user account, as shown in figure D-2.1a.
- ❗ **Reminding:** the application software provides two user names by default: **user** and **admin**.

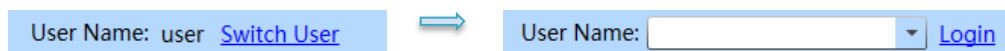

Figure D-2.1a. Quick Start Bar - Login

- ▶ **Quick Start** tab: includes four shortcut keys: < **New Experiment** >, < **New Experiment from Test Template** >, < **New Experiment from Existing Experiment** >, < **Open Data File** > and < **Instrument Management** >.
- Click < **New Experiment** > and the application software will automatically pop up the new experiment dialog box, as shown in figure D-2.1b. User can manually enter a name in the

Experiment Name input box and choose the experiment save path from **Save Path** drop down list, finally click < **New** > to create a new experiment file.

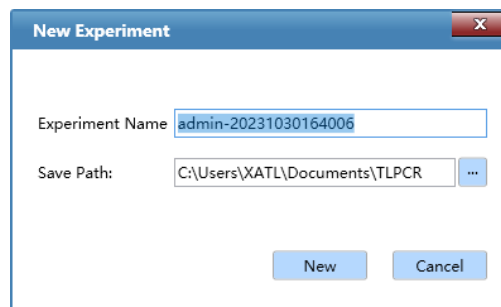

Figure D-2.1b Quick Start Bar - New Experiment

- ❗ **Reminding:** the application software defaults to name the current new experiment with the logged in user account name and experiment creation time.
- ❗ **Reminding:** the experiment name can consist of numbers, letters, horizontal lines, underlines, or Chinese characters, but cannot contain special characters.
- Click < **New Experiment from Test Template** > and the new experiment window will automatically pop up, as shown in figure D-2.1c. User can input the **Experiment Name** and select the **Save Path** for the new experiment. According to the specific test item of the new experiment, user can select the test template and click < **New** >, the application software will create a new experiment file with same experiment settings as the selected test template.

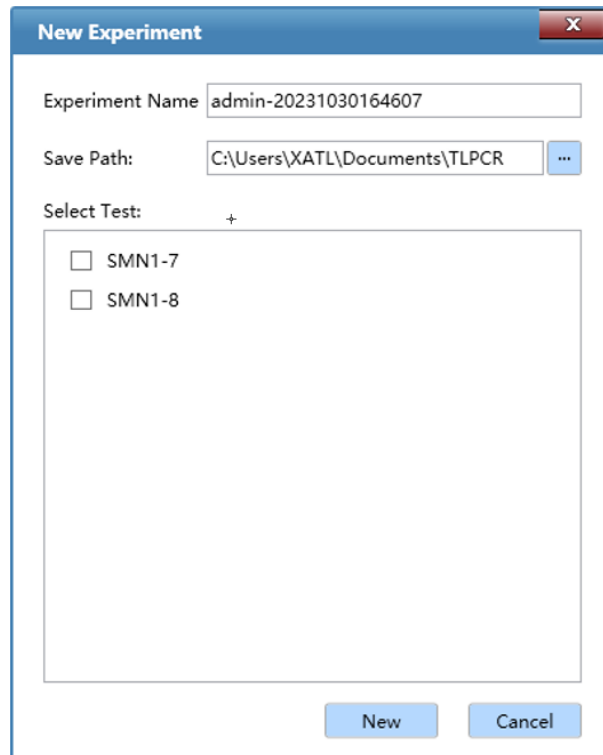



Figure D-2.1c. Quick Start Bar - New Experiment from Test Template

- Click **< New Experiment from Existing Experiment >** and the application software will automatically pop up the choose experiment file window; user can choose a pre-existed experiment file and click **< Open >**; then the application software will create a new experiment file with same experiment settings as the selected experiment file.
- Click **< Open Data File >** and the application software will automatically pop up the open experiment file window; user can select an experiment data file from the save path and click **< Open >** to view and analysis the experiment data file.
- Click **< Instrument Management >** and the application software will automatically pop up the instrument management interface; user can manage all instruments within the local area network (LAN). For operation details, please refer to **D-3.1 Menu Bar - Tool (T) submenu- Instrument Management**.
- ▶ **Recent Files** tab: display the recent experiment or data files and user can directly click the file name to open the file.
- ▶ **Details**: the details of the default instrument are displayed at the bottom part of quick start bar, including **IP Address, On-line, Loading Platform** and **Status** information; when user open the application software again after setting the default instrument, the application software will automatically connect the default instrument and display its status.

- ▶ User can check the **Display at Startup** check box to decide whether to open the quick start bar automatically when starting the application software.
 - ▶ User can click the  icon on the upper right corner of quick start bar to close the quick start bar. To open the quick start bar again, please click **View > Quick Start [Ctrl + G]** in the menu bar of application software's main interface or click <  **Quick Start** > icon in the toolbar to open the quick start bar.
-

3. Main Interface

After closing the quick start bar, the application software will automatically enter the main interface, which consists of menu bar, tool bar and operational area, as shown in figure D-3.

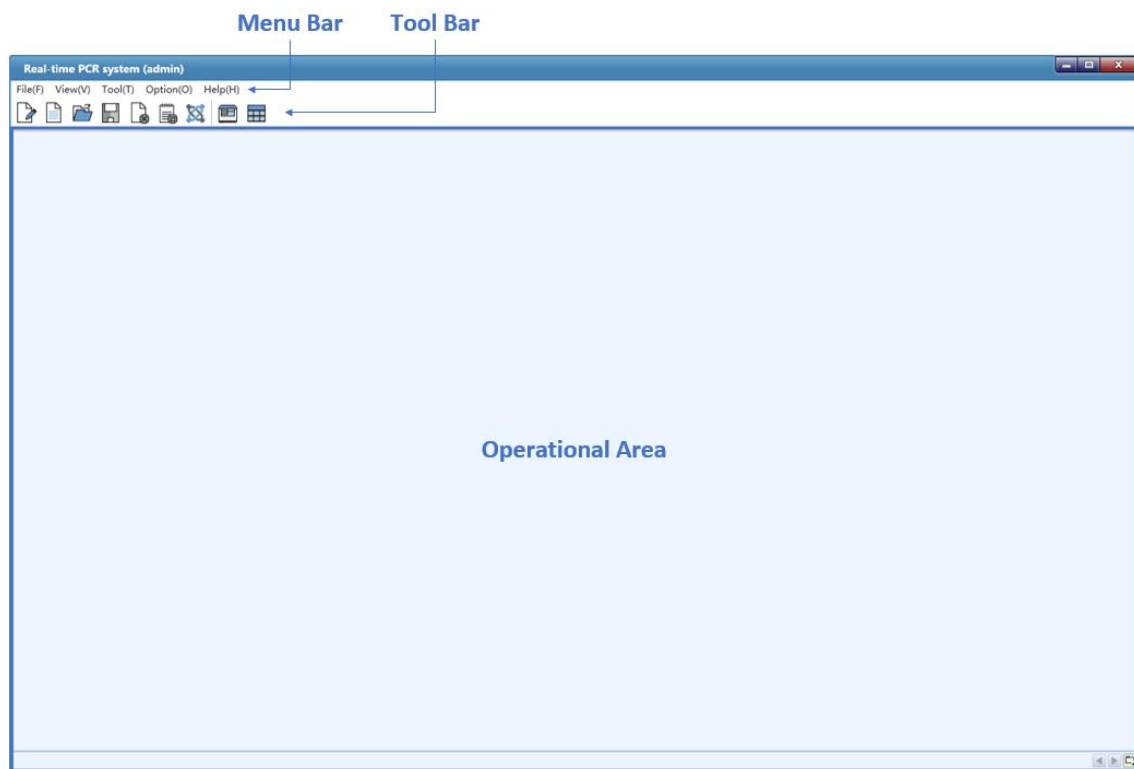

Figure D-3. Main Interface

3.1 Menu Bar

The menu bar of application software includes: **File (F)**, **View (V)**, **Tool (T)**, **Option (O)** and **Help (H)** five submenus.

File (F) submenu: includes following options.

Options and Functional Description

1. **New Experiment (N)**: create a new experiment.
 2. **New Experiment from Test Template**: user can select a saved test template and create a new experiment file with same experiment settings as the selected test template.
 3. **New Experiment from Existing Experiment**: user can select a saved experiment file and create a new experiment file with same experiment settings as the selected experiment file.
 4. **New Experiment from PANA or Other Device**: Gentier instrument can be connected with PANA nucleic acid workstation and the Gentier application software can establish experiment according to the PCR reaction system established by the PANA nucleic acid workstation.
 5. **Open Data File...**: user can select an experiment data file from the save path and click < **Open** > to view and analysis the experiment data file.
 6. **Recent Files**: user can click the experiment name from the list to open the selected data file.
 7. **Close Experiment**: close an opened or created experiment file.
 8. **Save...**: the experiment file is saved to the default file path.
 9. **Save As...**: user shall specify another file save path and save the experiment file.
 10. **Export Raw Data ...**: user can choose a path to export the experiment raw data file.
 11. **Export All Data Sheets to Excel ...**: user can choose a path to export the experiment data as an Excel file.
 12. **Report Manager**: user can edit and manage the experiment report information after the experiment.
 13. **Exit**: exit and close the application software.
-

View (V) submenu: includes following options.

Options and Functional Description

1. **Quick Start:** open the **Quick Start** bar. For detailed functions, refer to [D-2 Quick Start Bar](#).
2. **View Log:** user can view the operation type, time and remarks of the instrument.
3. **Show Toolbar:** user can decide whether to **Show Toolbar** on the main interface of application software. For detailed functions, refer to [D-3. Main Interface - 3.2 Tool Bar](#).
4. **Show Instrument Information:** user can decide whether to **Show Instrument Information** on the main interface of application software.
 - ▶ If user check the **Show Instrument Information** option in the **View** submenu, the instrument information area will be displayed on the top right corner of main interface to remind user the current status of the connected Gentier instrument, as shown in figure D-3.1.

On-line: ■ Loading Platform: Close Status: Ready

Figure D-3.1 View Submenu - Instrument Information Area

- **On-line:** display the connection status between the application software and the instrument: ■ indicates disconnected status; ■ indicates connected status;
- **Loading Platform:** display the status of Loading Platform, which is **Close** or **Open**;
- **Status:** display the running state of the connected instrument, which is **Ready** or **Running**.

Tool (T) submenu: includes following options.

Options and Functional Description

1. **Instrument Management:** Click **Instrument Management** option in **Tool** submenu and the application software will automatically pop up the instrument management interface, which consists of three parts: **Instrument List**, **Details** tab and **File Transmission** tab, as shown in figure D-3.2. User can manage all instruments within the LAN on this interface.

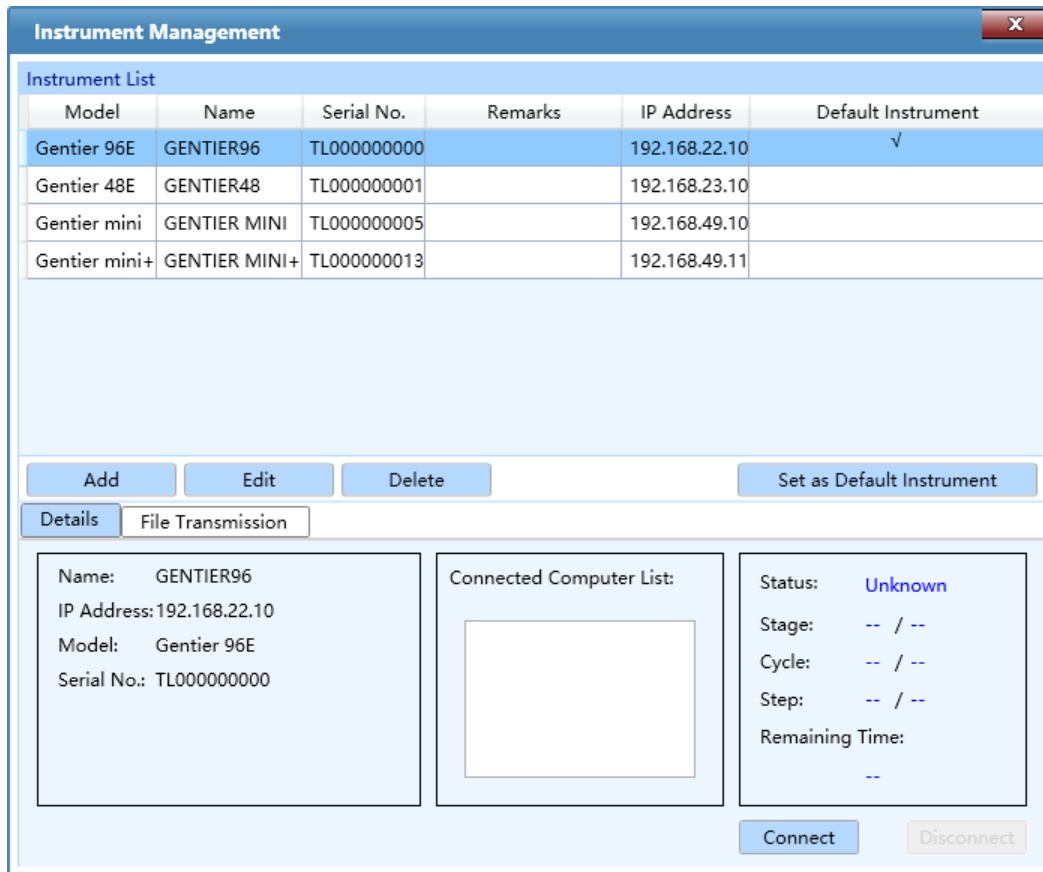

Figure D-3.2. Tool Submenu - Instrument Management Interface

- **Instrument List:** displays relevant information of instrument connected, including **Model**, **Name**, **Serial No.**, **Remarks**, **IP Address** and whether the instrument is set as the **Default Instrument**. There are four function keys under the list: **< Add >**, **< Edit >**, **< Delete >** and **< Set as Default Instrument >**.

- a. Click **< Add >** and the **Add Instrument** window will automatically pop up, as shown in figure D-3.2a.

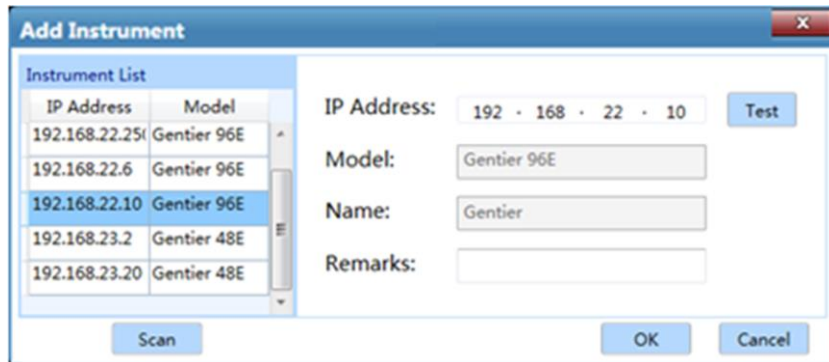

Figure D-3.2a. Instrument Management Interface - Add Instrument Window

- User can click < **Scan** > and the application software will automatically scan all identifiable Gentier instrument within LAN and display their **IP Address** and **Model** in **Instrument List**.
 - User can double click a certain instrument IP address in the **Instrument List** and the selected IP address will be displayed in the **IP Address** input box on the right; click < **Test** > and the application software will test the selected IP address; if the test passes, the selected instrument can be connected, then click < **OK** > to add the current instrument.
 - If user already know the IP address of a certain instrument, you can also manually enter the address in **IP Address** input box and click < **Test** >; if the test passes, the selected instrument can be connected, then click < **OK** > to add the current instrument.
- b. Click < **Edit** > and the Edit Instrument window will be automatically popped up; user can change the remarks of instrument in the **Remarks** input box, as shown in figure D-3.2b.

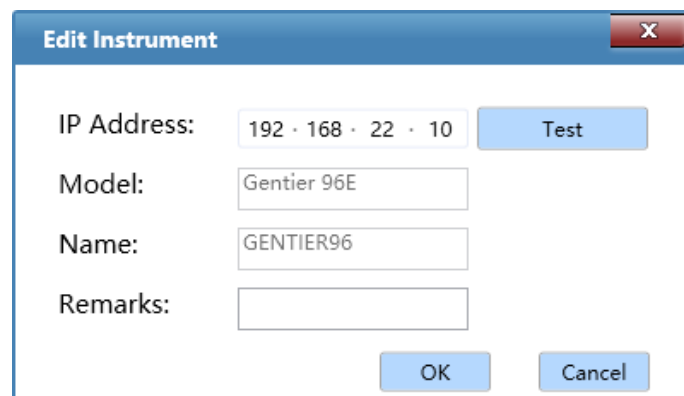

Figure D-3.2b. Instrument Management Interface - Edit Instrument Window

- c. Click < **Delete** > to delete the instrument selected in the list.
- d. Select any instrument in **Instrument List** and click < **Set as Default Instrument** > to set it as the default instrument, it will be automatically connected after application software startup.

- **Details** tab: includes 3 information areas and two function keys, as shown in figure D-3.2c.

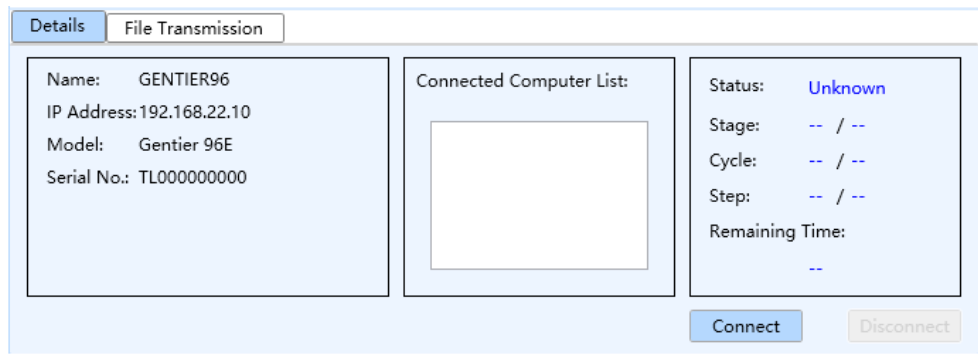

Figure D-3.2c. Instrument Management Interface - Details Tab

a. Information Areas:

- Instrument Information Area: display the relevant information of instrument selected in the *Instrument List*, such as *Name*, *IP Address*, *Model*, *Serial No.* and *Version No.* of instrument components, etc.
- Computer information Area: display the IP address list of the *Connected Computer* within LAN.
- ❗ **Reminding:** the IP address of the *Connected Computer* should be set according to the default IP address of Gentier instrument.
- Running information Area: display the real-time *Status* of connected instrument, such as *Stage*, *Cycle*, *Step* and *Remaining Time*.

b. Function keys:

- Click < *Connect* > to connect the instrument selected in the *Instrument List*.
 - Click < *Disconnect* > to disconnect the connected instrument.
- **File Transmission** tab: to transmit the file between the control computer and the connected Gentier instrument, as shown in figure D-3.2d.

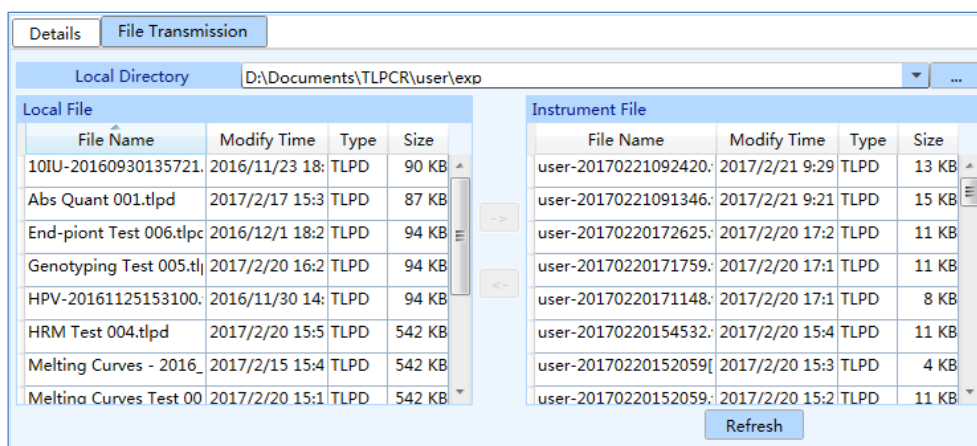

Figure D-3.2d. Instrument Management Interface - File Transmission Tab

- a. **Local Directory:** user can select a local experiment file directory or experiment data file directory from the drop-down list of **Local Directory**.
 - b. **Local File:** after selecting a **Local Directory**, the **Local File** list will display all experiment files and data files in this directory.
 - c. **Instrument File:** display all experiment files and data files saved in the connected instrument.
 - Click < → > to download the selected **Local File** to the connected instrument.
 - Click < ← > to upload the selected **Instrument File** to the control computer and save in the **Local Directory** selected by user.
 - Click < Refresh > to refresh the displayed **Instrument File** list.
2. **T_m Calculator:** Click **T_m Calculator** option in **Tool** submenu and the application software will automatically pop up the T_m Calculator interface, as shown in figure D-3.3.

Figure D-3.3. Tool Submenu - T_m Calculator Interface

Interface Introduction and Functional Description

- ▶ User can click **A T G C** four keys to input the forward primer sequence in **Forward Primer** input box;
 - ▶ User can click **A T G C** four keys to input the reverse primer sequence in **Reverse Primer** input box;
 - ▶ User can input the salt concentration value in **Salt Concentration** input box by using the keyboard or **↑ ↓** keys;
 - ▶ User can click **< Calculate >** and the application software will automatically calculate **Fwd Primer T_m value, Rev Primer T_m value, Avg. T_m value** and **Annealing Temperature**.
3. **Research Report:** Click **Research Report** option in **Tool** submenu and the application software will automatically pop up the research report interface, as shown in figure D-3.4.

⚠ Reminding: user shall create an experiment before entering the research report interface.

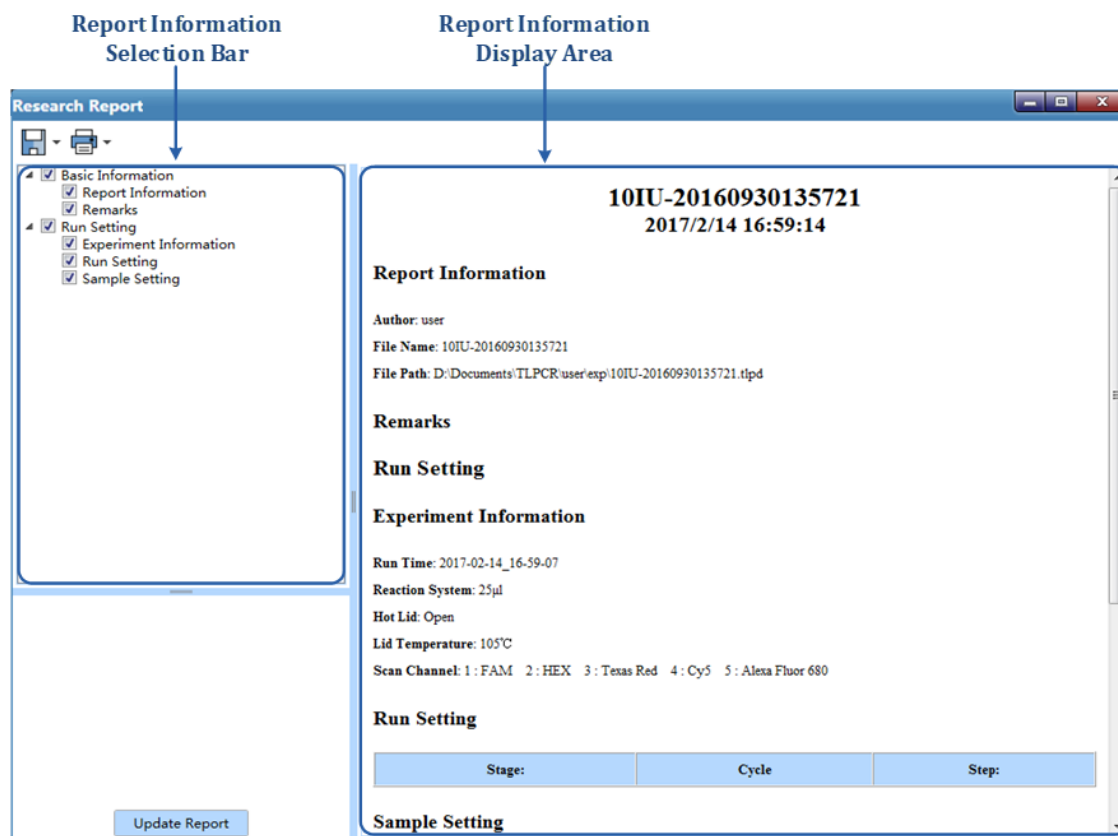



Figure D-3.4. Research Report Interface - Research Report

Interface Introduction and Functional Description

- ▶ **Report Information Selection Bar:** user can check the relevant information check boxes in the report information selection bar to determine the information to be displayed and printed in research report.
- ▶ **Report Information Display Area:** display the information selected in the report information selection bar.
- ▶ **Update Report:** user can click < *Update Report* > to refresh the information in the research report.
- ▶ **Save Research Report:** after editing the research report, please click <  *Save* > icon to choose a path for saving the research report and choose a file format from the drop-down list after the icon to save the research report as a PDF or html file.
- ▶ **Print Research Report:** After editing the research report, user could click <  *Print* > icon to choose a printer and select *Print* option from the drop-down list after the icon to print the

current research report, or select **Print Preview** option from the drop-down list after the icon to preview the research report.

4. **New Test Template:** click the **New Test Template** option in **Tool** submenu and the application software will automatically pop up the test template interface, which consists of three tabs: **Basic Information**, **Program** and **Analysis Parameters**. Users can set the parameters and information of the new test template in this interface. The test template interface displays the **Basic Information** tab by default, as shown in figure D-3.5a.

The screenshot shows the 'Test Template' window with the 'Basic Information' tab selected. The 'Test Name' field contains 'New Test Template'. There are checkboxes for 'SMA Test' and 'Set Excitation Gain', and input fields for 'Reaction Volume' (25 µL) and 'Lid Heating' (105 °C) with an 'Open' checkbox. The 'Reagent Name' is a dropdown menu. Below is the 'Test Target' section with 'Number of Well(s) for One Sample' set to 1 and 'Vertical' orientation. A table lists channels 1-4 with dye options (FAM, HEX, Texas Red, Cy5) and gain correction coefficients. A table below shows the well configuration for 'Well 1' with dye 'FAM' and 'Internal Control' unchecked. At the bottom, 'Suitable Instrument Model(s)' includes 'Gentier 48E' and 'Gentier 48R'.

Figure D-3.5a. Research Report Interface – Basic Information

- **Basic Information** tab: is as shown in figure D-3.5a.
 - a. **Test Name:** user can input the name of the new test template;
 - b. **SMA Test:** user can select if the new test is SMA test or not.
 - c. **Set Excitation Gain:** user can change the LED electric current of channel by selecting Set Excitation Gain.
 - d. **Reaction Volume:** user can input the reaction volume for the new test template;
 - e. **Lid Heating:** the user can input the hot lid temperature for the new test template and check the check box to determine whether to apply the lid heating function;
 - f. **Reagent Name:** user can select reagent crosstalk number for the new test.
 - g. **Test Target :**

- **Number of Well(s) for one sample:** user can manually input or use and keys to set the number well(s) for one sample, and select well arrangement orientation from the subsequent drop-down menu: **Horizontal** or **Vertical**.
- **Select Well :** user can select all wells or any well of the current sample for setting.
- **Dye :** user can set fluorescence dye(s) for all wells or any well of the current sample.
- **Gain Correction Coefficient :** user can check the check box of **Gain Correction Coefficient**, and set the fluorescence gain correction coefficient for the corresponding **Channel**.

❗ **Reminding:** after user completes the settings of **Select Well, Dye** and **Gain Correction Coefficient** for the current sample, the information of all sample wells will be displayed in the list, which consists of **No., Well, Dye, Internal Control** and **Gene** five columns. User can check any check box in the **Internal Control** column to set it as the internal control of the current sample and edit the name of the target gene for any well in the **Gene** column.

h. Suitable Instrument Model(s): user can select suitable instrument for the current template.

❗ **Reminding:** general user can only check the default instrument model of the current application software. Admin user can check different suitable instrument models according to different dye/channel settings.

► **Program** tab: is as shown in figure D-3.5b.

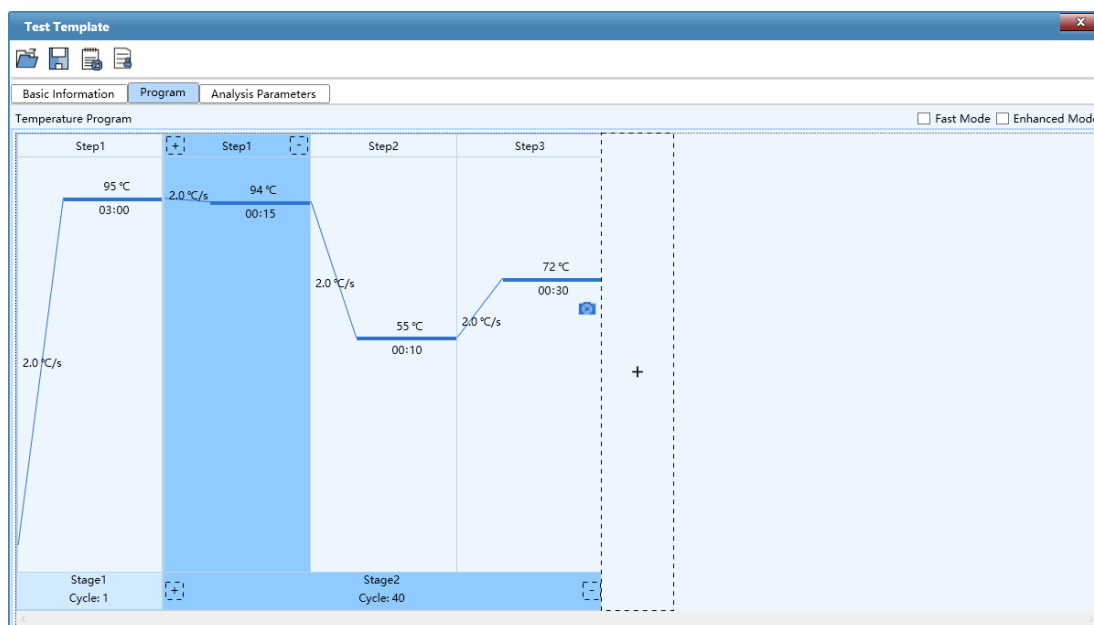

Figure D-3.5b. Research Report Interface – Program

► **Analysis Parameters** tab: is as shown in figure D-3.5c.

Test Template

Basic Information Program Analysis Parameters

Analytical Method: Abs Quant Select Stage: Stage2 Select Step: Step3





Parameter Setting

Manual Baseline Manual Threshold Internal Control Participation Analysis Real-time Prediction

No.	Dye	Gene	Internal Control	Positive Ct Threshold	Negative Ct Threshold	Positive Result	Negative Result
1	FAM		<input checked="" type="checkbox"/>	< 40.00	No Ct	Positive	Negative

Gray Area: Gray Area

Figure D-3.5c Research Report Interface – Analysis Parameters

- a. **Analytical Method** : user can set the corresponding analysis parameters for the current template according to the experiment type and data analysis requirement.
- b. **Select Stage** : user can choose the stages that need to be analyzed.
- c. **Select Step** : user can choose the step that need to be analyzed.
- d. **Parameter Setting** : the parameter setting list shows the corresponding parameters of samples, including: **No.**, **Well**, **Dye**, **Gene**, **Internal Control**, **Baseline Start Value** and **Baseline End Value**, **Threshold**, **Positive Ct Threshold**, **Negative Ct Threshold**, **Positive Result** and **Negative Result**. User can set the corresponding analysis parameters for the current template according to the experiment type and data analysis requirement.
 - **Manual Baseline** : when user select the **Abs Quant** analytical method for data analysis, the application software will check the check box of **Manual Baseline** by default, and show the **Baseline Start Value** and **Baseline End Value**. User can select any well in the parameter setting list, manually enter or use  and  keys to set the **Baseline Start Value** and **Baseline End Value**.
 - **Manual Threshold** : when user select the **Abs Quant** analytical method for data analysis, the application software will check the check box of **Manual Threshold** by default, and show the **Threshold**, **Positive Ct Threshold** and **Negative Ct Threshold** of each channel. User can select any well in the parameter setting list, manually enter or use  and  keys to set the **Threshold**, **Positive Ct Threshold** and **Negative Ct Threshold**.

- **Internal Control Participation Analysis** : when user select the **Abs Quant** analytical method for data analysis, user can check the check box of **Internal Control Participation Analysis** to determine whether to involve the internal control in data analysis.
 - **Real-time Prediction** : when user select the **Abs Quant** analytical method for data analysis, user can check the check box of **Real-time Prediction** to determine whether to real-time prediction the positive/negative results.
5. **Test Template Management**: click the **Test Template Management** in **Tool** submenu and the application software will automatically pop up the test template management interface, as shown in figure D-3.6.

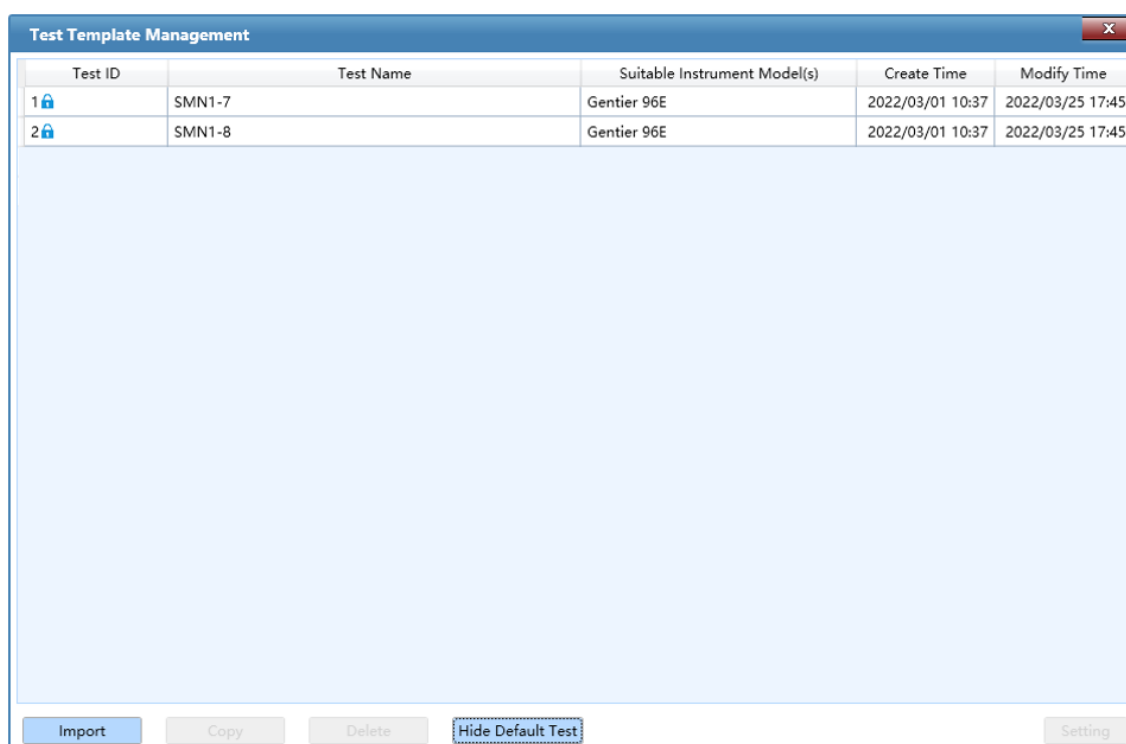

Figure D-3.6. Test Template Management

- ▶ **Test Template List**: user can view the test template information saved by the current application in the test template list, including **Test ID**, **Test Name**, **Suitable Instrument Model(s)**, **Create Time** and **Modify Time**.
- ▶ **Import**: user can click < **Import** > and select a test template to import it into the current application software.
- ▶ **Copy**: user can select a test template in the test template list and click < **Copy** > to copy it.
- ▶ **Delete**: user can select a test template, click < **Delete** > to delete from the test template list.

- ▶ **Hide Default Test:** user can hide the default test template by clicking < **Hide Default Test** >.
 - ▶ **Setting:** user can select any test template in the test template list and click < **Setting** > to modify the settings of this test template.
6. **Crosstalk Number Management:** user can add crosstalk number in **Crosstalk Number Management**, as shown in figure D-3.7.

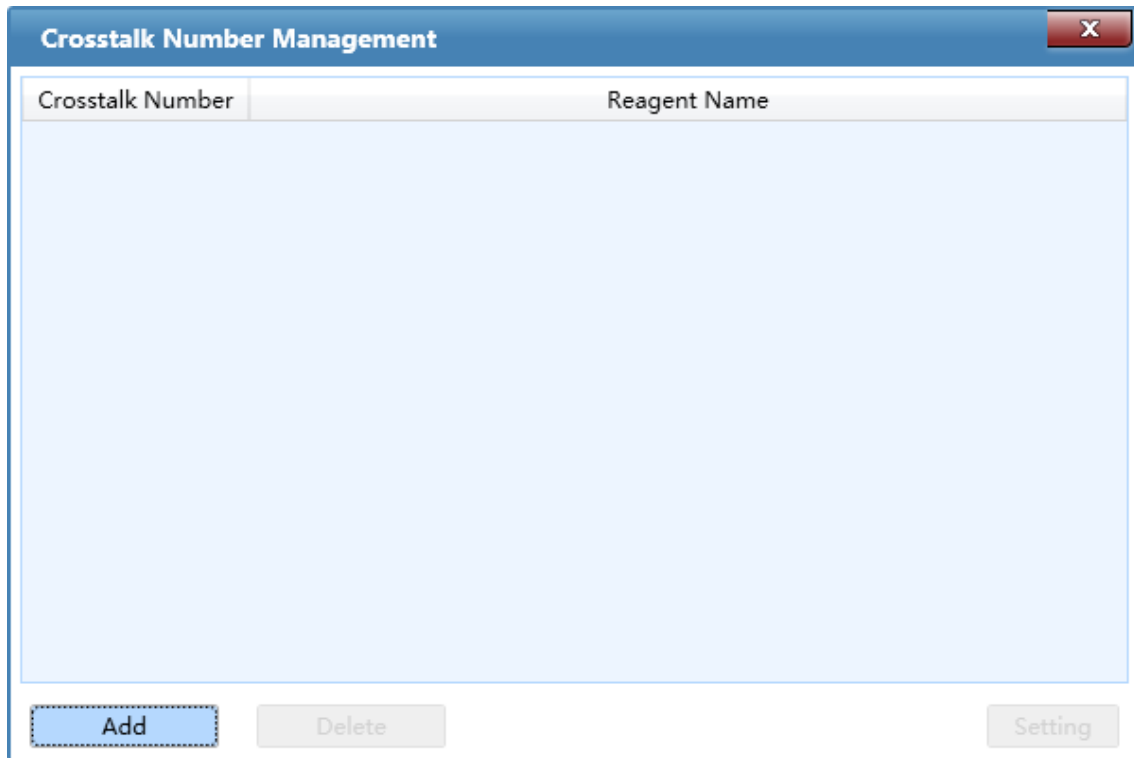

Figure D-3.7. Add Crosstalk Number

The software will automatically pop up add crosstalk number interface by clicking **Add**, as shown in figure D-3.7a.

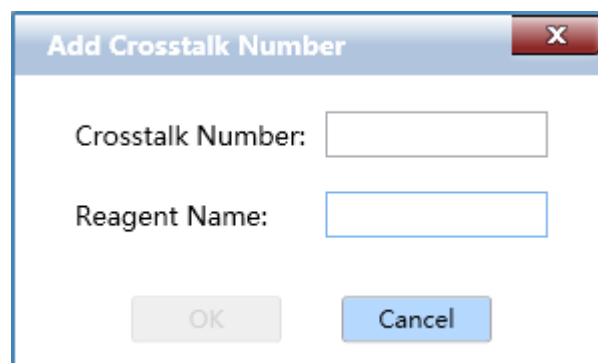

Figure D-3.7a. Add Crosstalk Number-Add

Option (O) submenu: includes following options.

Options and Functional Description

1. **Configuration Management:** Click **Configuration Management** option in the **Option** submenu and the application software will automatically pop up the configuration management interface, as shown in figure D-3.8a.

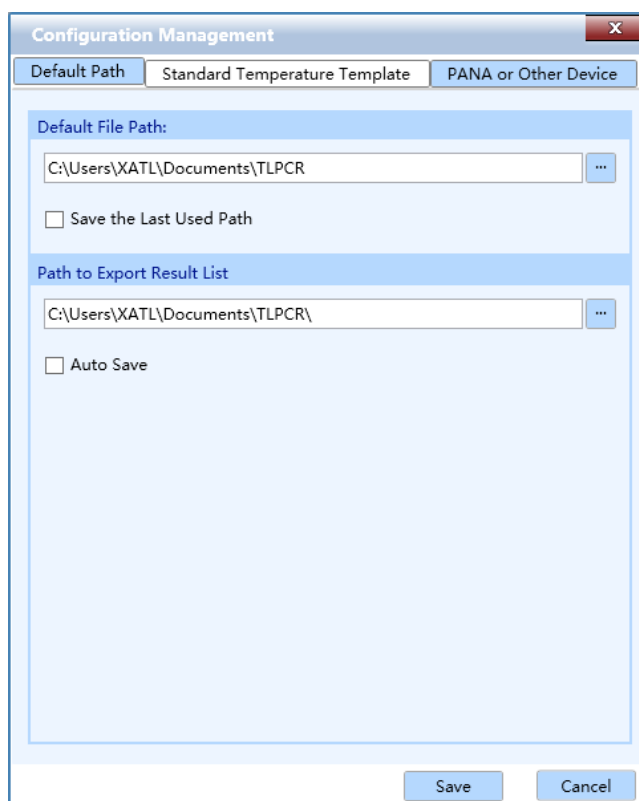



Figure D-3.8a. Option Submenu - Configuration Management Interface - Default Path Tab

Interface Introduction and Functional Description

- ▶ **Default Path** tab: the configuration management interface displays the **Default Path** tab by default, as shown in figure D-3.8a.
 - User can set the default path for saving run parameter template, sample parameter template and other experiment files in **Default Path** tab. User can manually enter the path name in **Default File Path** input box; or click  icon and select a path from the pop-up Browse Folder.
 - User can check **Save the last used path** check box to determine whether to save the last used path.
 - User can click  to select path to export result list.

- User can check Auto Save check box to determine whether to auto save or not.
- **Standard Temperature Template** tab: 7 predefined standard temperature templates are displayed in this tab, as shown in figure D-3.8b. These templates are provided by the application software for temperature program stage settings.

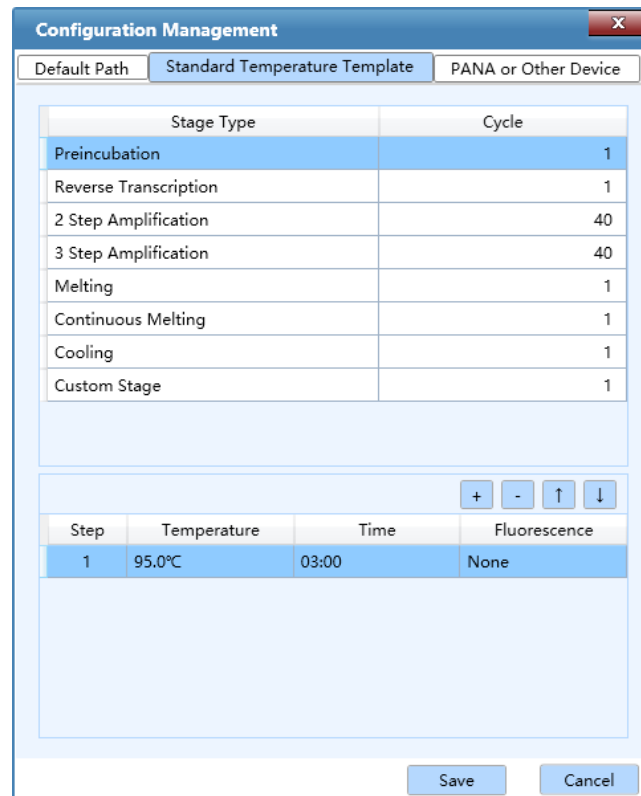

Figure D-3.8b. Configuration Management Interface - Standard Temperature Template Tab

- User can modify the predefined **Standard Temperature Template** in this tab, change the corresponding stage and step settings. For detailed information, please refer to [D-3.3 Operation Area - 3.3.1 Run Setting](#).
- **PANA or Other Device** tab: Gentier instrument can be connected with PANA nucleic acid workstation or other device of our company, and experiment can be created according to the PCR reaction system established by PANA nucleic acid workstation or other device, as shown in figure D-3.8c.
 - a. User can check the check box of **Connect to PANA or Other Device** and enter the IP address of the PANA automatic nucleic acid workstation or other device to be connected in the **IP Address** box.

- b. User can click **< Test >** to test whether the PANA automatic nucleic acid workstation or other device can be connected.
- c. **PANA or Device List:** display the connectable the **Device Name** and **IP Address** of PANA automatic nucleic acid workstation or other device.
 - User can click **< Add >** to add the connectable the PANA automatic nucleic acid workstation or other device to the PANA or other device list.
 - User can select any PANA automatic nucleic acid workstation or other device from the list, click **< Delete >** to delete it from the current list.
 - User can click **< Save >** to save all the operation at the **PANA or Other Device** tab.
 - User can click **< Cancel >** to cancel all the operation at the **PANA or Other Device** tab.

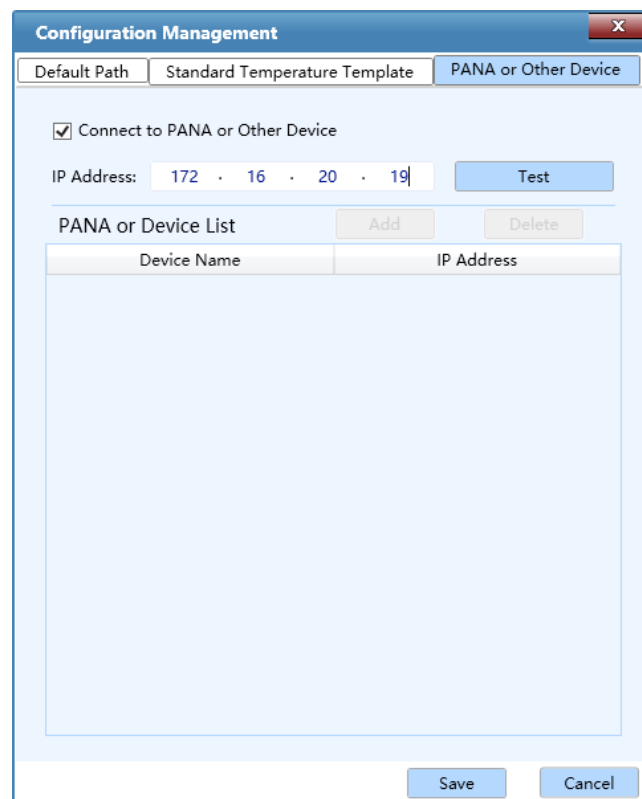

Figure D-3.8c. Configuration Management Interface - PANA Tab

2. **LIS Setting:** Click **LIS Setting** option in the **Option** submenu to set the LIS path and TL LIS path, as shown in figure D-3.9. Admin can check the check box to make sure if the auto export LIS, LIS Output Curve and Auto Export TL LIS are needed or not.

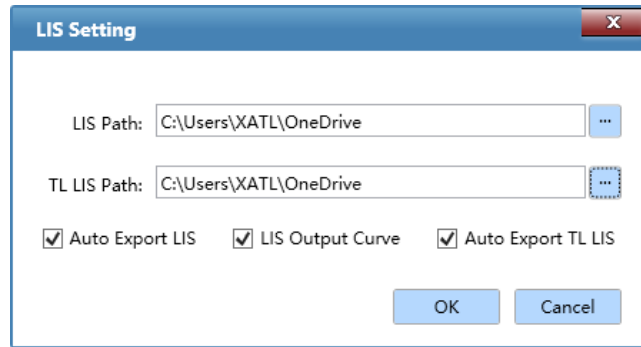

Figure D-3.9. LIS Setting

3. **Analysis Parameter Management:** Click **Analysis Parameter Management** option in the **Option** submenu and the application software will automatically pop up the analysis parameter management interface. User can manage the analysis parameters of different types of experiments in this interface.

Interface Introduction and Functional Description

- ▶ **Abs Quant** tab: the analysis parameter management interface displays the **Abs Quant** tab by default, as shown in figure D-3.10a. User can manage the analysis parameters of specific or multiple genes for absolute quantitative experimental results analysis.
 - User can click < **Add** > to add an analysis parameter setting for a specific gene, and input the **Gene Name** and **Ct Threshold** in the list.
 - User can click any gene in the list and click < **Delete** > to delete the analysis parameter setting for that gene.
 - User can click < **Save** > to save the analysis parameter setting for the current experiment.
 - User can click < **Cancel** > to cancel the analysis parameter setting for the current experiment.

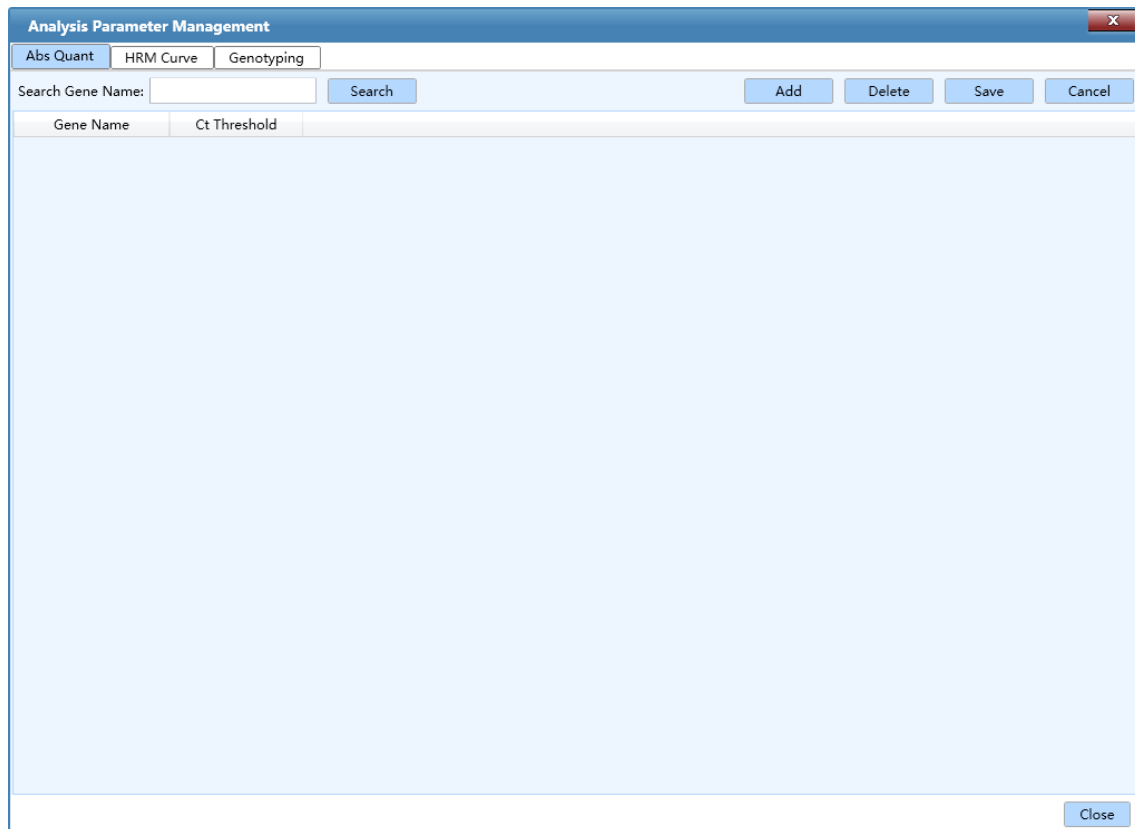

Figure D-3.10a. Parameter Management Interface - Abs Quant Tab

- ▶ **HRM Curve** tab: User can manage the analysis parameters of specific or multiple genes for high resolution melting experimental results analysis on the **HRM Curve** tab, as shown in figure D-3.10b.
 - User can click < **Add** > to add an analysis parameter setting for a specific gene, and fill in the **Gene Name**, select the **Normalization Method** and manually input the **Pre-Melt Range**, **Post-Melt Rang**, **Delta Tm Discrimination**, **Curve Shape Discrimination** and **Temperature Compensation**.
 - User can click any gene in the list and click < **Delete** > to delete the analysis parameter setting for that gene.
 - User can click < **Save** > to save the analysis parameter setting for the current experiment.
 - User can click < **Cancel** > to cancel the analysis parameter setting for the current experiment.

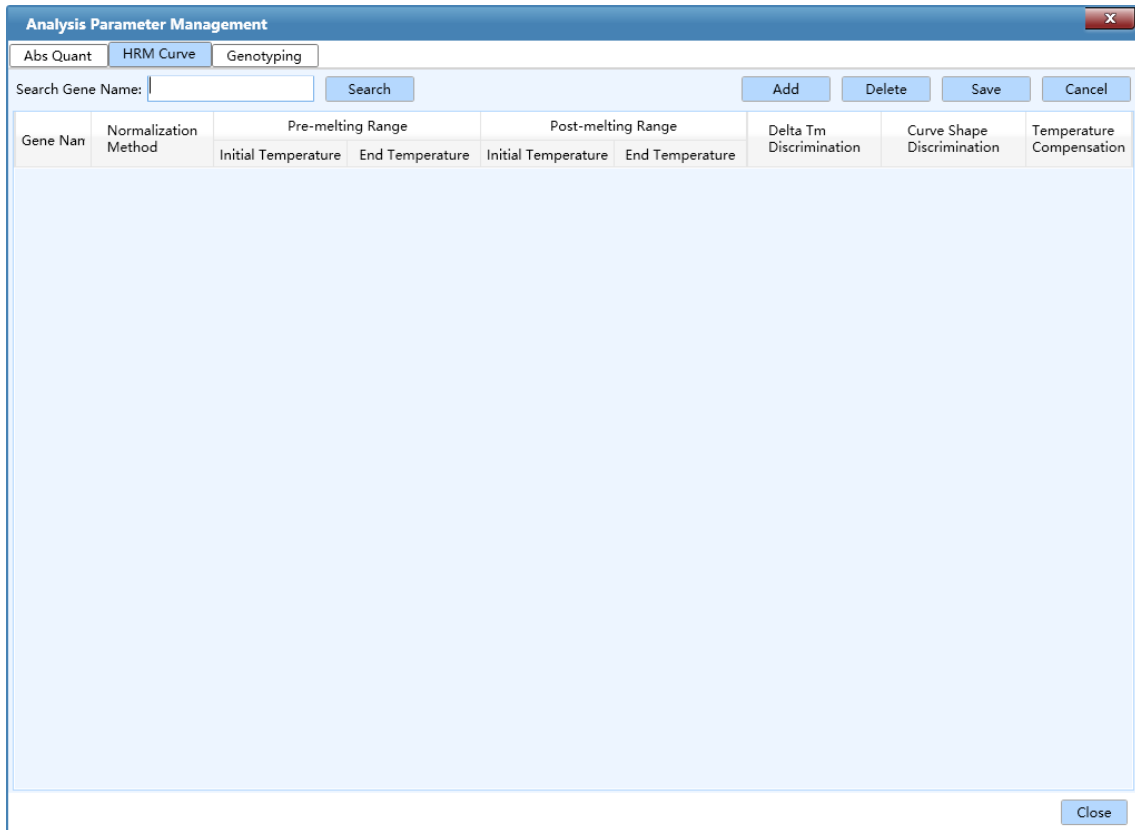

Figure D-3.10b. Parameter Management Interface - HRM Curve Tab

- ▶ **Genotyping** tab: User can manage the analysis parameters of specific or multiple genes for genotyping experimental results analysis on the **Genotyping** tab, as shown in figure D-3.10c.
 - User can click < **Add** > to add an analysis parameter setting for a specific gene, and fill in the **Gene Name** and manually input the **Allelic Gene X**, **Allelic Gene Y** and **Heterozygote**.
 - User can click any gene in the list and click < **Delete** > to delete the analysis parameter setting for that gene.
 - User can click < **Save** > to save the analysis parameter setting for the current experiment.
 - User can click < **Cancel** > to cancel the analysis parameter setting for the current experiment.

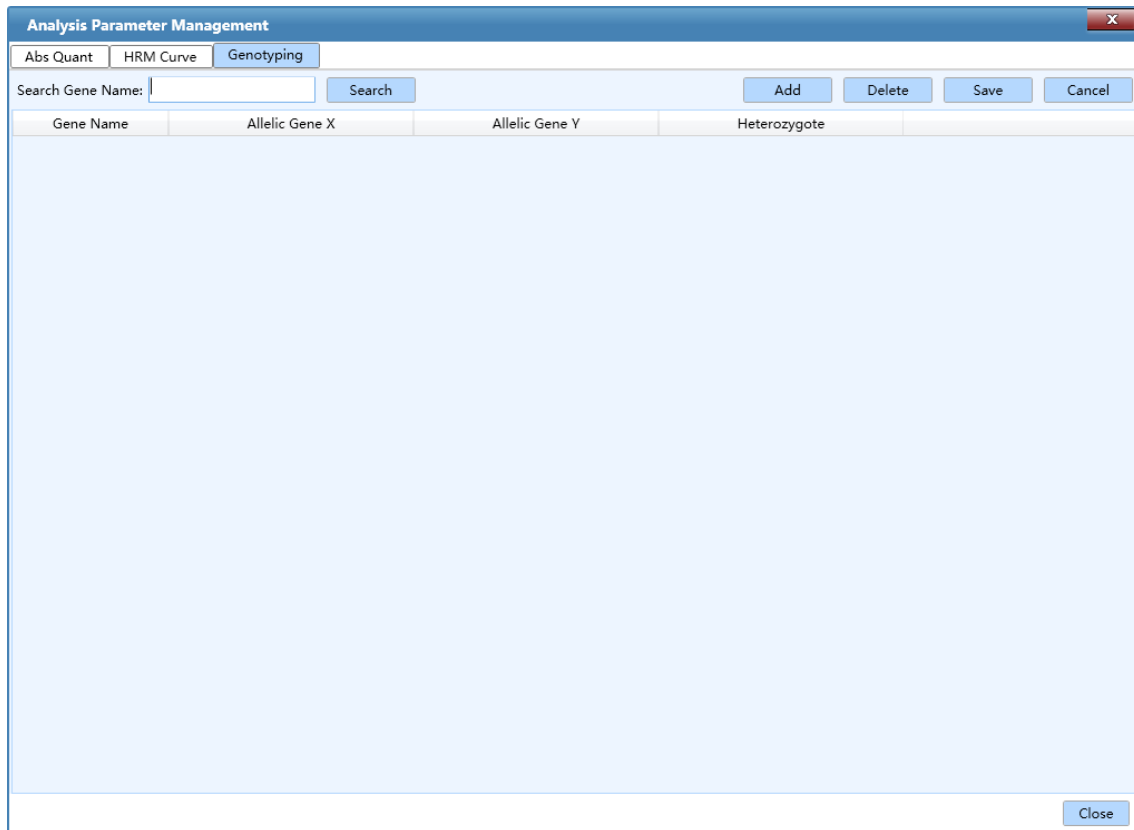

Figure D-3.10c. Parameter Management Interface – Genotyping Curve Tab

4. **User Management** tab: if user login as **admin** user account (the password is "admin"), user can manage general user accounts in this tab.

User can click **Admin** or **User** in **User List** to review relevant user information.

- < **Add User** >: **admin** user can add general user accounts in **User Management** tab.
- < **Delete User** >: **admin** user can delete general user accounts in **User Management** tab.
- < **Edit User** >: **admin** user can edit general user accounts in **User Management** tab.
- < **Reset User Password** >: **admin** user can reset the password by clicking **Reset User Password**.

- **Role Management** tab: as shown in figure D-3.11a.

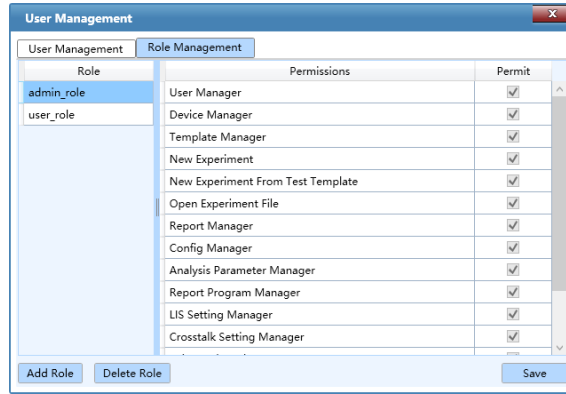

Figure D-3.11a. User Interface - General User Permissions Tab

- a. If user login as **admin** user account, user can manage general user permissions by clicking **user_role**.
 - **Admin** user can set the general user permissions by check relevant **Permissions** check box in the **Permit** column.
 - **Admin** user can click < **Add Role** > to add new user.
 - **Admin** user can click < **Delete Role** > to delete user.
 - **Admin** user can click < **Save** > to save the current general user permission settings.
 - b. If user login as general user account, user can view the general user permissions in this tab.
5. **Change permissions:** when user click **Change permissions**, all new experiment or program shall be needed input password (med97-21), only experiment from existing experiment does not need password.
 - **Retrieve permission password:** user click **Retrieve permission password** to retrieve password.
 - **Change permission password:** user click **Change permission password** to change password.
 6. **Choose Language:** click **Choose Language** option in the **Option** submenu and the application software provide two optional software languages:
 - **Chinese:** check **Chinese** option and the software language will switch to Chinese after restarting the application software.
 - **English:** check **English** option and the software language will switch to English after restarting the application software.

Help (H) submenu: includes following options.

Options and Functional Description

1. **Home Page:** visit the home page of Xi'an Tianlong Science and Technology Co., Ltd.
2. **About:** display the application software version and copyright information, as shown in figure D-3.12.

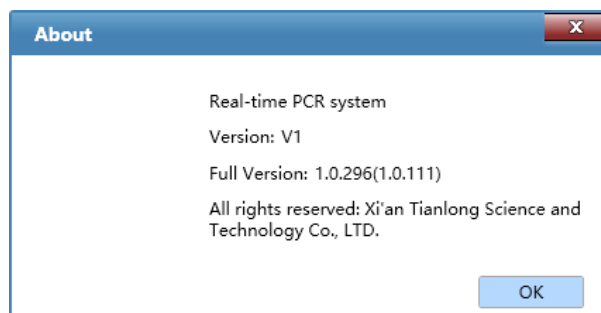











Figure D-3.12. Help Submenu - About Interface

3.2 Tool Bar

The Tool Bar of the application software consists of nine commonly used function icons.

Options and Functional Description

- ▶ <  **New Experiment** >: create a new empty experiment.
- ▶ <  **New Experiment from Existing Experiment** >: user can select an existed experiment file and create a new experiment file with same experiment setting as the selected experiment file.
- ▶ <  **Open Data File** >: open a data file for viewing or analyzing.
- ▶ <  **Save Experiment** >: the experiment file is saved to the default file path set in configuration management interface.
- ▶ <  **Close Experiment** >: close an opened experiment file.
- ▶ <  **Export** >: after experiment, user can choose a path to export the raw experiment data as an Excel file.
- ▶ <  **Report Manager** >: user can edit report template and print report.

- ▶ <  **Instrument Management** >: click to enter the instrument management interface. For detailed operation, please refer to [D-3.1 Menu Bar - Tool \(T\) submenu- Instrument Management](#).
- ▶ <  **Quick Start** >: click to open the quick start bar. For detailed operation, refer to [D-2 Quick Start Bar](#).

3.3 Operation Area

After creating a new experiment file or open an experiment file, the operation area on the main interface of the application software will be activated, as shown in figure D-4.

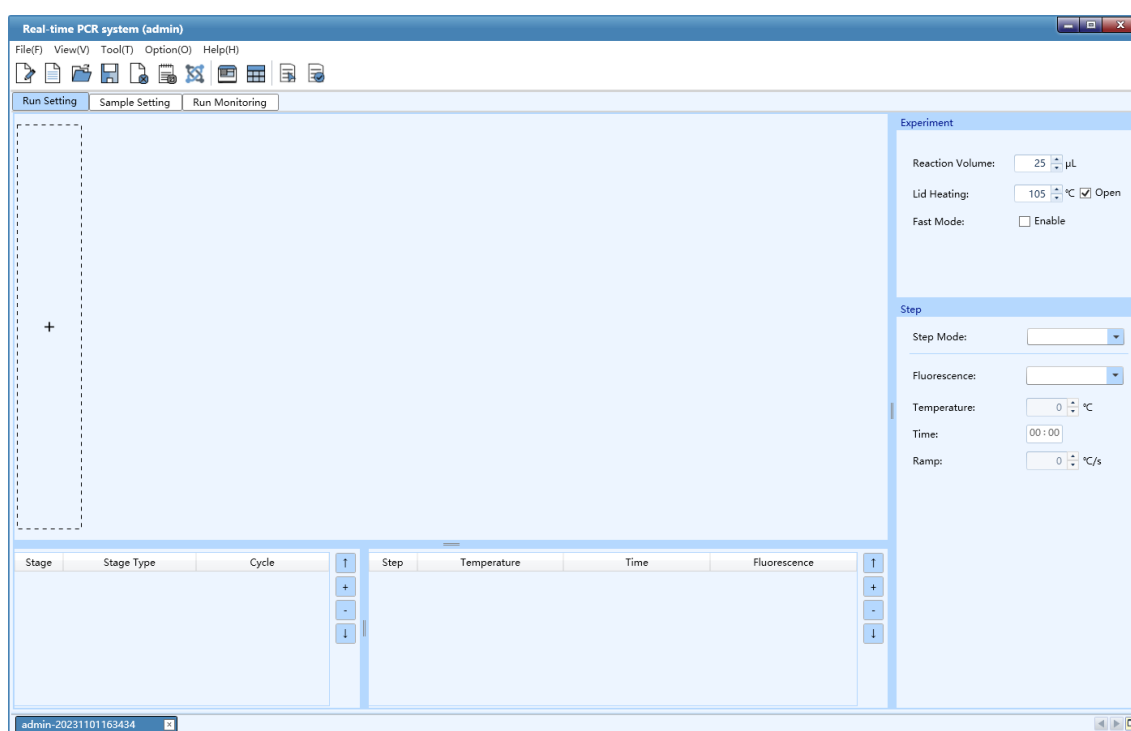





Figure D-4. Operation Area on Main Interface



1. The experiment file created or opened will be displayed in the experiment file tab at the bottom of operation area and user can select or close any experiment file in this tab.
 - ❗ **Reminding:** if several experiment files are created or opened at the same time, user can click  and  icon on the right side of the experiment file tab to view all experiment files; or click  icon to view the list of all experiment files.
2. After user creates a new experiment, **Run Setting**, **Sample Setting** and **Run Monitoring** three tabs will be added in the operation area. User can select corresponding tab for experiment

setting and monitoring; After the new experiment is complete, the **Analysis** tab will be added in the operation area, so that user can analysis the experimental results.



 **Reminding:** if user opens a completed experiment file, **Run Setting, Sample Setting, Run Monitoring** and **Analysis** four tabs will be added in the operation area.

3. When the application software is in the interface of **Run Setting, Sample Setting, Run Monitoring** or **Analysis** tab, different function icons will be shown accordingly in the tool bar of application software.



▶ **Run Setting** tab: when the **Run Setting** tab is selected on the main interface, two additional function icons will be shown in the tool bar on the run setting interface.

- <  **Choose Run Parameter Template** >: click this icon in the tool bar and the application software will automatically pop up choose run parameter template window; user can choose a saved run parameter template set the current experiment based on the selected template.
- <  **Save Run Parameter Template** >: click this icon in the tool bar and the application software will automatically pop up save run parameter template window; user can choose a path and save the parameters of current experiment as a template.

▶ **Sample Setting** tab: when the **Sample Setting** tab is selected, two additional function icons will be shown in the tool bar on the sample setting interface.

- <  **Choose Sample Parameter Template** >: click this icon in the tool bar and the application software will automatically pop up choose sample parameter template window; user can choose a saved sample parameter template and set current experiment based on this template.
- <  **Save Sample Parameter Template** >: click this icon in tool bar and the application software will automatically pop up save sample parameter template window; user can choose a path and save the sample parameters of current experiment as a template.

▶ **Analysis** tab: when the **Analysis** tab is selected, four additional function icons will be shown in the tool bar on the analysis interface.

- <  **New Analysis** >: after the completion of experiment, user can click this icon in the tool bar to create a new analysis method based on the current experiment data; the application software provides user with six analysis methods: **Abs Quant, Rel Quant, Melting Curve, High Resolution Melting, Genotyping** and **End Point Fluorescence**.
- <  **Analysis Setting** >: after the completion of experiment, user can click this icon in the tool bar to set the relevant parameters for the current experiment data analysis method.
- <  **Delete Analysis** >: user can click this icon in the tool bar to delete the selected analysis method.

- <  **Export Lis** >: after the completion of experiment, user can click this icon in the tool bar to export the current experiment data.

3.3.1 Run Setting

The operation area on main interface displays **Run Setting** tab by default, as shown in figure D-5.

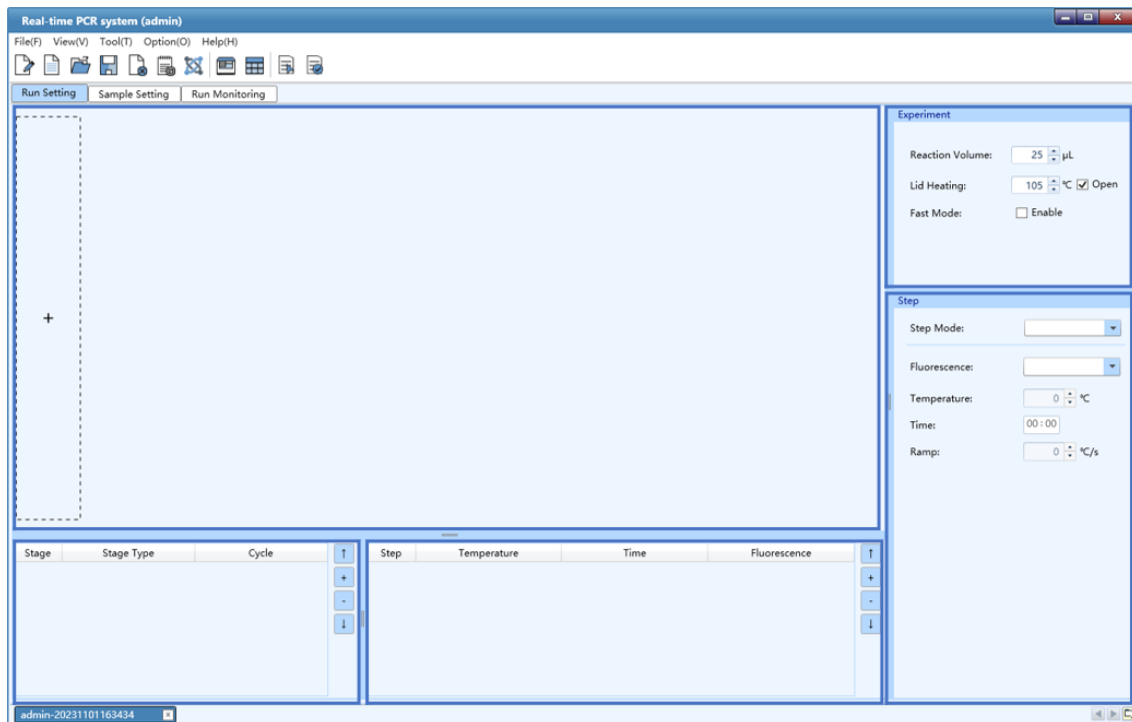

Figure D-5. Run Setting Interface

Run Setting

The Run Setting interface consists five parts: temperature program area, stage and step lists, experiment and step editing areas.

1. **Temperature program area**: user can view the temperature program of the current experiment, or edit its stages and steps in this area, as shown in figure D-5.1.

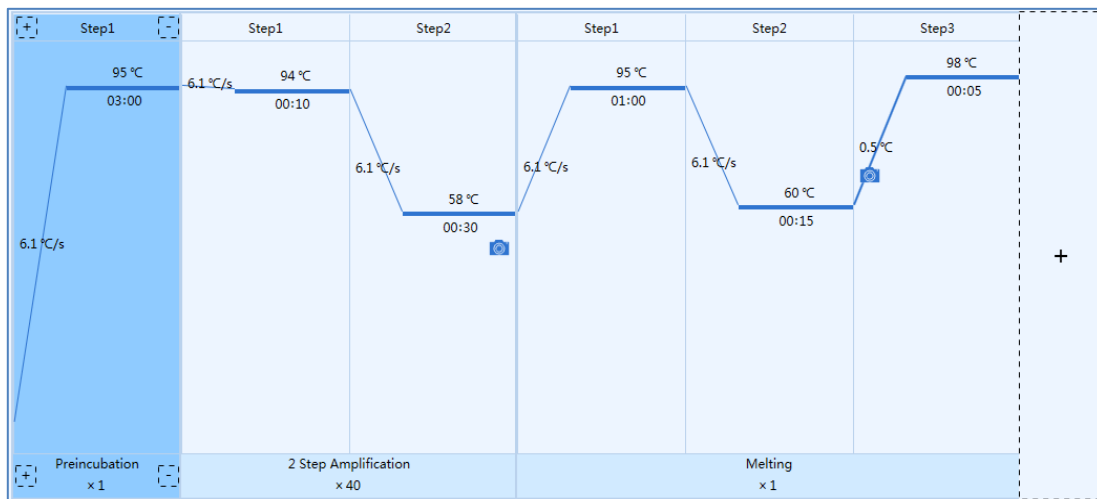



Figure D-5.1. Temperature Program Area – Example Temperature Program

Introduction to Temperature Program Area

- Stages are longitudinal separated; if a stage contains several steps, these steps are separated by solid blue line;
- The corresponding stage type and cycle number are displayed below each stage box and the corresponding step number is displayed above the step box;
- Inside each step box, the corresponding temperature of the current step is shown above the solid blue line and corresponding time of the current step is show below the solid blue line;
- The solid blue line between two stages/steps represents the temperature ramp, or increment or readings of melting step;
- If user decide to read the fluorescence at a certain step,  icon will be displayed in the corresponding step box.

⚠ Reminding: user can hover mouse over the temperature and time of a certain step in the temperature program area, and the application software will display the temperature setting details of this step.

⚠ Reminding: user can double click any step box in the temperature program area and edit the current step in the pop-up **Step Setting** dialog box.

2. **Experiment Editing Area:** user can edit the relevant parameters of the current experiment in the experiment editing area, as shown in figure D-5.2.

The screenshot shows a window titled "Experiment" with the following settings:

- Reaction Volume: 25 μL
- Lid Heating: 105 $^{\circ}\text{C}$ Open
- Fast Mode: Enable

Figure D-5.2 Experiment Editing Area

- ▶ **Reaction Volume:** user can enter the reaction volume for current experiment in the **Reaction Volume** input box.
 - ❗ **Reminding:** the reaction volume setting range is 0 μL - 100 μL .
 - ▶ **Hot Lid:** user can enter the hot lid temperature in the **Hot Lid** input box. User can also check the **Open** check box to determine whether to use the hot lid heating function.
 - ❗ **Reminding:** the hot lid temperature setting the range is 40.0 $^{\circ}\text{C}$ - 110.0 $^{\circ}\text{C}$.
 - ▶ **Fast Mode:** user can check **Enable** check box to set the fast mode to experiment.
3. **Stage list:** as shown in figure D-5.3.

Stage	Stage Type	Cycle
1	Preincubation	1
2	2 Step Amplification	40
3	Melting	1

Navigation buttons: ↑, +, -, ↓

Figure D-5.3. Stage List





Stage List Introduction



- ▶ **Stage:** display the number of each stage.
- ▶ **Stage Type:** display the type of each stage.
- ▶ **Cycle:** display the cycle number of each stage. User can double click this number, manually enter or use and keys to set the cycle number of relevant stage.

❗ **Reminding:** user can also double click the cycle number below the stage box in the temperature program area to complete the cycle setting.

❗ **Reminding:** the cycle number setting range is 1-99.

▶ User can add or delete any stage according to the experiment requirements or adjust the sequence of each stage.

- User can click <  **Add** > icon to add a new temperature stage.
- User can click <  **Delete** > icon to delete the selected stage.
- User can click <  **Up** > icon to move up the selected stage.
- User can click <  **Down** > icon to move down the selected stage.

❗ **Reminding:** User can also click  icon in the dotted box of temperature program area or click <  **Insert Stage** > icon below any stage box to add a new stage.

❗ **Reminding:** User can also click <  **Delete Stage** > below any stage box in the temperature program area to delete the stage.

▶ If user add a new stage, the application software will automatically pop up a stage type window, as shown in figure D-5.4.

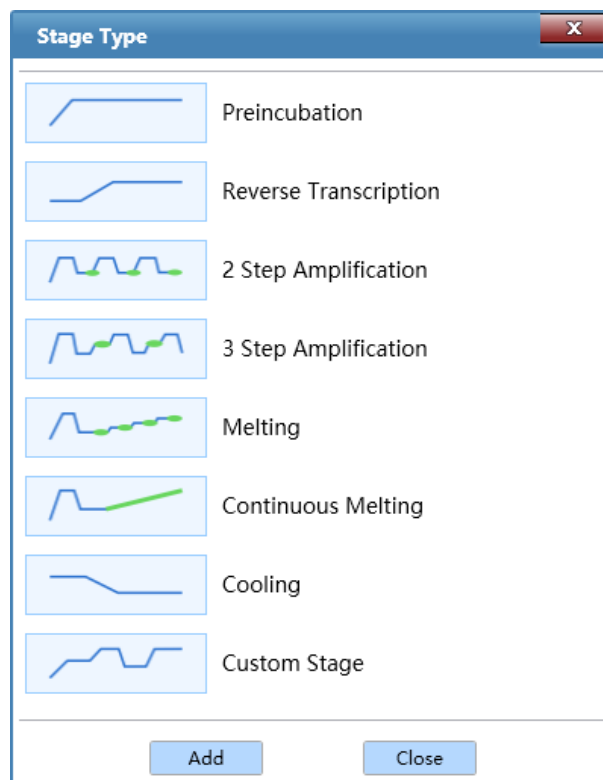

Figure D-5.4. Stage Type Window

Introduction to Stage Type Window

- ▶ The application software provides the following stage types: **Preincubation**, **Reverse Transcription**, **2 Step Amplification**, **3 Step Amplification**, **Melting**, **Continuous Melting** and **Cooling**. User can choose the corresponding predefined stage in the stage type window and click **< Add >** to add the selected stage; or double click any stage to add directly.
 - ▶ User could select **Custom Stage** and click **< Add >** to define the stage setting according to specific experiment requirements.
 - ▶ After adding a stage, please click **< Close >** to return to the run setting interface. The new stage will be added to the temperature program area and stage list.
- ⓘ **Reminding:** at least one stage should be included in the temperature program.



4. **Step list:** as shown in figure D-5.5.

Step	Temperature	Time	Fluorescence
1	95.0°C	01:00	None
2	60.0°C	00:15	None
3	98.0°C	00:05	Reading

Figure D-5.5. Step List

Step List Introduction

- ▶ **Step:** display the number of each step;
- ▶ **Temperature:** display the target temperature of the current step.;
- ▶ **Time:** display the temperature holding time of the current step;
- ▶ **Fluorescence:** display whether to read fluorescence at the current step;
- ▶ User can add/delete the step according to the experiment requirements or adjust the sequence of each step.
 - User can click **< + Add >** icon to add a new temperature step.
 - User can click **< - Delete >** icon to delete the selected step.
 - User can click **< ↑ Up >** icon to move up the selected step.
 - User can click **< ↓ Down >** icon to move down the selected step.

❗ **Reminding:** user can also click <  **Insert Step** > or <  **Delete Step** > above any step box in the temperature program area to add or delete a temperature step.

- Step Setting:** double click any step in the step list or in temperature program area to edit the selected step, the application software will pop up the **Step Setting** dialog box for user to edit the selected step, as shown in figure D-5.6a.

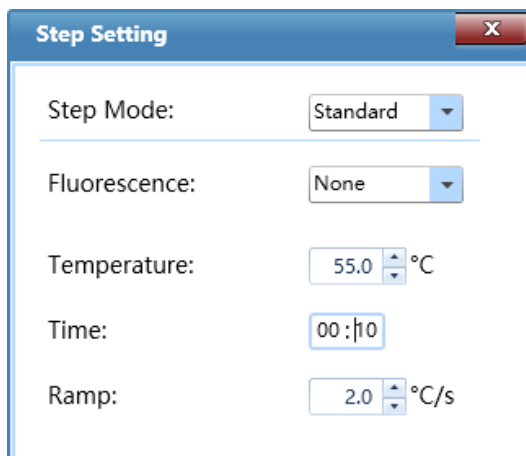



Figure D-5.6a. Step Setting Dialog Box – Standard Step Mode

Introduction to Step Setting Dialog box

Step Mode: user can set the step mode for the selected step in the drop-down list of *Step Mode*, which including *Standard*, *Touchdown*, *Long* and *Gradient*.

Step Mode \ Model	96E	96T	96R
<i>Standard</i>	✓	✓	✓
<i>Touchdown</i>	✓	✓	✓
<i>Long</i>	✓	✓	✓
<i>Gradient</i>	✓	✓	✓

- Standard Step Mode:** user can set the *Temperature*, *Time*, *Ramp* for the standard step and decide whether to read its *Fluorescence*, as shown in figure D-5.6a.
 - ▶ **Fluorescence:** user can decide whether to read the fluorescence at current step from the drop-down list of *Fluorescence* according to the experiment requirements.
 - ▶ **Temperature:** the temperature will be held for a defined time. User can use  and  keys, or manually enter the current step temperature in the *Temperature* input box.

- ❗ **Reminding:** the temperature setting range is 0.0°C -100.0°C.
 - ▶ **Time:** the time for which the temperature is to be held. User can enter the current step time in the **Time** input box.
 - ❗ **Reminding:** the time setting range is 1s~60min.
 - ❗ **Reminding:** If the current step is the last step of temperature program, user can check the ∞ check box to set the current step time to infinite.
 - ▶ **Ramp:** the rate of temperature changes per second. User can use and keys, or manually enter the temperature change rate in the **Ramp** input box.
 - ❗ **Reminding:** the ramp setting range is 0.1°C/s~6.1°C/s.
- II. **Touchdown Step Mode:** the touchdown step mode allows the temperature program to change the annealing step temperature from the initial temperature to the target temperature as the cycling proceeds. User could set the corresponding parameters in the **Step Setting** dialog box, as shown in figure D-5.6b.

Parameter	Value	Unit
Step Mode	Touchdown	
Fluorescence	None	
Initial Temperature	55.0	°C
Target Temperature	50.0	°C
Delta Temperature	1.0	°C/Cycle
Time	00:10	
Start Cycle	1	
Ramp	2.0	°C/s

Figure D-5.6b. Step Setting Dialog Box – Touchdown Step Mode

- ▶ **Initial Temperature:** the initial value of annealing temperature change range.
- ▶ **Target Temperature:** the target value of annealing temperature change range.
- ▶ **Delta Temperature:** the temperature changes per cycle.
- ▶ **Start Cycle:** the cycle number after which the temperature change is started.
- ❗ **Reminding:** the initial and target temperature setting range is 0.0 °C - 100.0 °C.
- ❗ **Reminding:** the start cycle setting range is 1-max cycle number of the current stage.
- ❗ **Reminding:** the Delta Temperature setting range is 0.1°C- 5.0°C.

III. **Long Step Mode**: the long step mode allows the temperature program to change the elongation step temperature holding time from the initial time to the target time as the cycling proceeds. User could set the corresponding parameters in the **Step Setting** dialog box, as shown in figure D-5.6c.

Figure D-5.6c. Step Setting Dialog Box – Long Step Mode

- ▶ **Initial Time**: the initial value of the elongation time change range.
- ▶ **Target Time**: the target value of the elongation time change range.
- ▶ **Delta Time**: the time change per cycle.
- ▶ **Start Cycle**: the cycle number after which the time change is started.
- ⚠ **Reminding**: the initial initial and target time setting range is 1s~60min.
- ⚠ **Reminding**: the delta time setting range is 1s~10min.
- ⚠ **Reminding**: the star cycle range is 1~ max cycle number of the current stage.

IV. **Gradient Step Mode**: the gradient step mode allows the sample block to adopt different temperatures. User can set the **Temperature Center** and **Temperature Offset** values for the current gradient step, as shown in figure D-5.6d. The system will then automatically calculate the corresponding gradient temperatures.

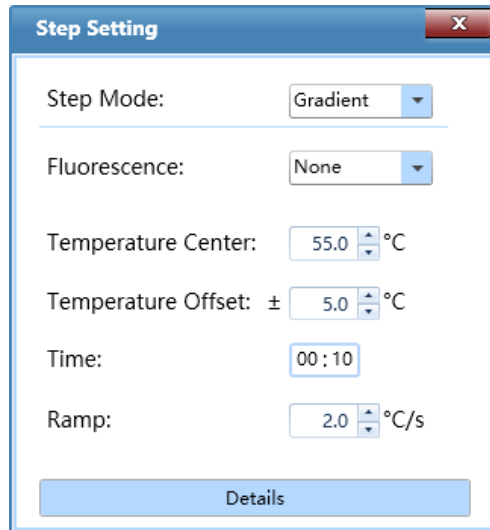

Figure D-5.6d. Step Setting Dialog Box – Gradient Step Mode

⚠ **Reminding:** the temperature center setting range is 35.5°C - 99.5°C.

⚠ **Reminding:** the temperature offset setting range is 0.5°C - 20.0°C.

▶ **Details:** User can click < *Details* > to the specific gradient temperatures of each column and the Gradient distribution, as shown in figure D-5.6e.

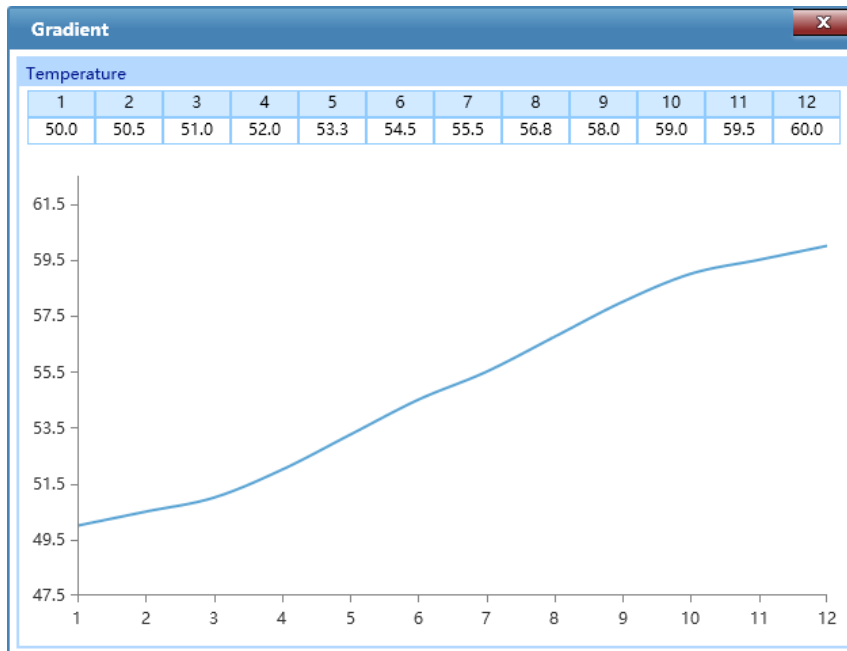





Figure D-5.6e. Step Setting Dialog Box – Gradient Temperature Details

- V. **Melting**: the system will read the fluorescence signals after each temperature increment at the melting stage. If the current step is the last step of melting stage, user can set the temperature **Increment** in the **Step Setting** dialog box, as shown in figure D-5.6f.



Figure D-5.6f. Step Setting Dialog Box – Melting Step

- **Increment**: the temperature change(°C) after which the system will read the fluorescence. User can use  and  keys, or manually enter the temperature increment in the **Increment** input box.

 **Reminding**: the temperature increment setting range is 0.1°C - 5.0°C.

- VI. **Continuous Melting**: continuous melting stage allows the system to read the fluorescence more frequently. If the current step is the last step of continuous melting stage, user can set the fluorescence reading times per °C for the current step in the **Step Setting** dialog box, as shown in figure D- 5.6g.

Figure D-5.6g. Step Setting Dialog Box – Continuous Melting Step Mode

- **Readings**: the fluorescence reading times per °C. User can use  and  keys, or manually enter the fluorescence reading frequency in the **Readings** input box.

 **Reminding**: the fluorescence reading frequency setting range is 2–15 readings/°C.

3.3.2 Sample Setting

After finishing the experiment run setting, user can click **Sample Setting** tab to enter the sample setting interface, which is consisted of sample setting area and sample property editing area, as shown in figure D-6.

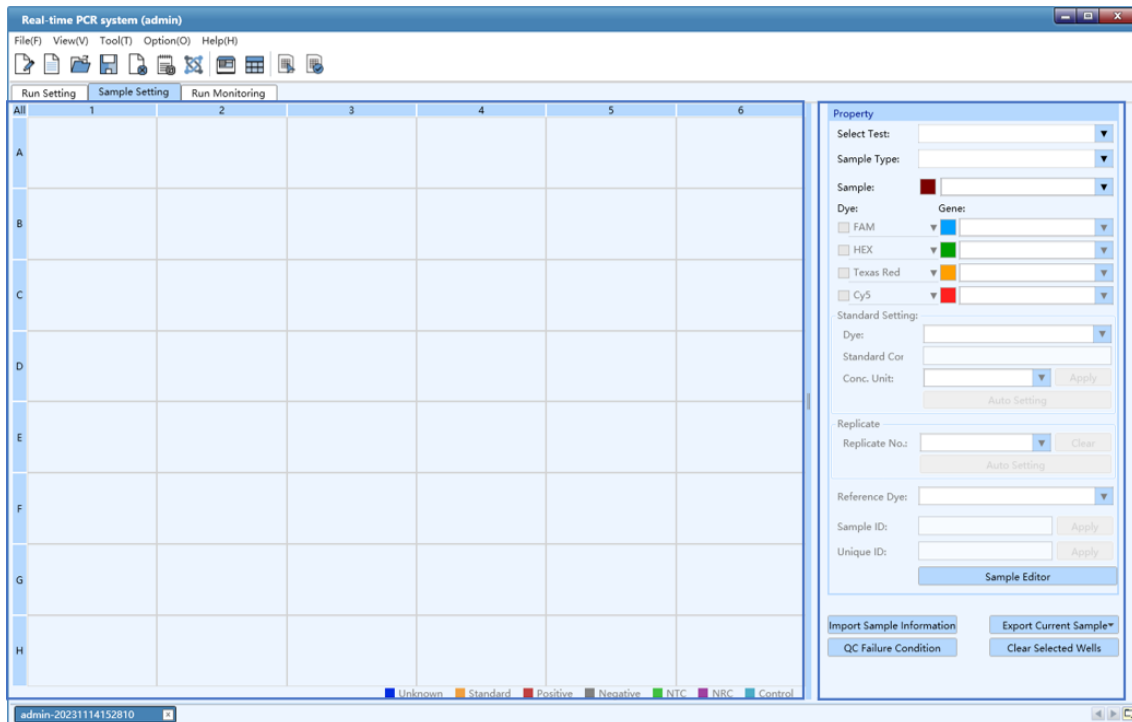

Figure D-6. Sample Setting Interface

Sample Setting Operation

1. **Sample Setting Area:** After entering the sample setting interface, user shall first choose a sample well in the sample setting area, as shown in figure D-6.1. The well distribution in sample setting area corresponds to the sample block well distribution in loading platform. There are 96 sample wells in total arranged in 12 columns (1-12) and 8 rows (A-H).

All	1	2	3	4	5	6	7	8	9	10	11	12
A												
B												
C												
D												
E												
F												
G												
H												

Figure D-6.1. Sample Setting Interface - Sample Setting Area

Introduction to Sample Setting Area

- ▶ User can select the relevant sample well in the sample setting area and operations as follows:
 - Click and select a single well in sample setting area to.
 - Press **[Ctrl]** key on computer keyboard and click corresponding wells to select multiple discontinuous wells;
 - Press **[Ctrl]** key on computer keyboard and click corresponding column number to select multiple discontinuous columns of wells;
 - Press **[Ctrl]** key on computer keyboard and click corresponding row number to select multiple discontinuous rows of wells.
 - Click the left mouse button and drag the mouse in sample setting area to select multiple continuous wells;
 - Click the left mouse button and drag the mouse on the column number to select multiple continuous columns of wells, or
 - Click the left mouse button and drag the mouse on the row number to select multiple continuous rows of wells.
 - Click **< All >** on the top left corner of sample setting area to select all sample wells.

2. **Sample Property Setting Area:** after selecting one or more sample wells in the sample setting area, user can set the properties for the corresponding wells in the sample property setting area.
- **Sample Property Box:** user can **Select Test** and set the **Sample, Sample Type, Dye, Gene** for the selected wells, as shown in figure D-6.2.

Figure D-6.2. Sample Setting Interface - Sample Property Box

- a. **Select Test:** if user has created an experiment from the test template, as described in [D-2.1 Quick Start Bar - < New Experiment from Test Template >](#). The **Select Test** drop-down list will be activated, user can select the test template for the selected well.
- ⚠ **Reminding:** if user has created an experiment through other way, the **Select Test** drop-down list will not be activated.
- b. **Sample Type:** user can set the relevant sample type for the selected wells from the **Sample Type** drop-down list. The optional sample types and their corresponding colors in sample setting area are ■ **Unknown**, ■ **Standard**, ■ **Positive**, ■ **Negative**, ■ **NTC**, ■ **NRC**, and ■ **Control**.
- c. **Sample:** user can enter the relevant sample name for the selected well in **Sample** input box or select a sample name from the drop-down list;
- ⚠ **Reminding:** user can click the color block before the **Sample** input box to select a data analysis color for all samples with the current sample name.
- d. **Dye:** user can check the relevant dye check box to determine the detection dyes for the selected wells.

- ❗ **Reminding:** figure D-6.2 takes 96E instrument models of real-time PCR system as an example, the application software displays the corresponding dye of six channels.
- e. **Gene:** user can enter the relevant gene name for the selected wells in **Gene** input box or select a gene name from the drop-down list;
- ❗ **Reminding:** user can click the color block before the **Gene** input box to select a data analysis color for all samples with the current gene name.
- ▶ **Standard Setting:** if the sample type for the selected well is ■ **Standard**, the **Standard Setting** box will be activated, as shown in figure D-6.3.

The image shows a 'Standard Setting' dialog box with the following fields and controls:

- Dye:** A dropdown menu currently showing 'FAM'.
- Standard Conc.:** A text input field containing '0.000E+00'.
- Conc. Unit:** A dropdown menu currently showing 'IU/ml'.
- Buttons:** An 'Apply' button to the right of the 'Conc. Unit' dropdown, and an 'Auto Setting' button centered at the bottom of the dialog.

Figure D-6.3. Sample Setting Interface - Standard Setting Box

- a. **Dye:** user can set the dye for corresponding standard curve from the **Dye** drop-down list.
- ❗ **Reminding:** please first set the detection dye for the selected standard samples in the sample property box, and then set the dye for the corresponding standard curve from the **Dye** drop-down list in the standard setting box.
- b. **Standard Conc.:** user can select a single standard sample and enter its standard concentration in **Standard Conc.** input box.
- c. **Conc. Unit:** user can select a single standard sample and set its concentration unit from **Conc Unit** drop-down list; The application software provides two default concentration units: **IU/ml** and **Copies/ml**.
- d. After editing the standard concentration and concentration unit for the selected standard sample, please click **< Apply >** to confirm the relevant settings.
- e. For a series of standard samples diluted according to a certain dilution factor, user can select corresponding standard sample wells in the sample setting area and let the application software to automatically calculate and set the relevant standard concentration for this series of standard samples. Please click **< Auto Setting >** and the auto concentration setting window will pop up automatically, as shown in figure D-6.4.

The screenshot shows a dialog box titled "Auto Concentration Setting". It has a blue header bar with the title and a close button (X). The main area is divided into several sections:

- Concentration:** Contains two fields: "Starting Conc." with the value "1.000E+01" and "Dilution Factor" with a dropdown menu showing "10x".
- Dye:** A dropdown menu showing "FAM".
- Replicate:** A dropdown menu showing "1".
- Direction:** A dropdown menu showing "Horizontal".
- Caution:** A section with two lines of text: "Horizontal: From Left to Right" and "Vertical: From Up to Down".

At the bottom of the dialog are two buttons: "OK" and "Cancel".

Figure D-6.4. Sample Setting Interface - Auto Concentration Setting Window

- User can set the starting concentration for a series of diluted standard samples in the **Starting Conc.** input box;
- User can select the concentration dilution factor for a series of diluted standard samples from **Dilution Factor** drop-down list;
- User can select the dye for the corresponding standard curve of a series of diluted standard samples from **Dye** drop-down list;
- User can select the number of standard samples from **Replicate** drop-down list;
- User can select the auto concentration setting direction from **Direction** drop-down list: **Horizontal** (from left to right) and **Vertical** (from up to down);
- User can click < **OK** > and the application software will conform to the auto concentration setting direction, calculate and display the concentration of all the selected standard samples.
- User can click < **Cancel** > and the application software will give up the current auto concentration setting and return back to the sample setting interface.

- **Replicate**: according to experiment requirements, user can classify the same samples into one replicate group in the **Replicate** group setting box, as shown in figure D-6.5.

Figure D-6.5. Sample Setting Interface - Replicate

- Replicate No.:** user can select the corresponding sample wells in the sample setting area and select the replicate group number from the **Replicate No.** drop-down list, to classify the selected same samples into one replicate group.
- User can click < **Clear** > to cancel the replicate group number setting.
- The application software can automatically divide multiple replicate groups according to user' requirements. Please first select all wells of same samples in the sample setting area and click < **Auto Setting** >; then the auto setting dialog box will pop up automatically, as shown in figure D-6.6.

Figure D-6.6. Sample Setting Interface - Auto Setting

- User can select the number of same samples in each replicate group from the **Replicate Size** drop-down list;
- User can select the starting value for replicate group number from the **Starting Replicate** drop-down list;
- User can select the direction for auto setting from **Direction** drop-down list: **Horizontal** (from Left to right) and **Vertical** (from up to down);

- Click < **OK** > and the application software will automatically divide the replicate group for all the selected samples;
- User can click < **Cancel** > and the application software will give up the current replicate setting and automatically return to the sample setting interface.

▶ **Sample ID :**

- User can select a well in the sample setting area and set the sample ID for the selected well in the **Sample ID** input box; click < **Apply** > to confirm the sample ID;
- User can also select multiple wells in the sample setting area, and let the application software to set the corresponding sample IDs. Please enter the starting ID number in the **Sample ID** input box and click < **Apply** >; the choose direction dialog box will pop-up, user could set the **Horizontal** or **Vertical** direction and then click < **OK** >, the application software will automatically set the sample IDs for the selected wells according to the direction setting.

▶ **Unique ID:**

- User can select a well in the sample setting area and set the unique ID for the selected well in the **Unique ID** input box; click < **Apply** > to confirm the unique ID;
- User can also select multiple wells in the sample setting area, and let the application software to set the corresponding unique IDs. Please enter the starting ID number in the **Unique ID** input box and click < **Apply** >; the choose direction dialog box will pop-up, user could set the **Horizontal** or **Vertical** direction and then click < **OK** >, the application software will automatically set the unique ID for the selected wells according to the direction setting.

 **Caution:** The **Sample ID** and **Unique ID** should be at least double-digit, and last two digits must be numbers.

 **Reminding:** The **Sample ID** setting is primarily intended to facilitate operators to identify and differentiate samples. Samples can only be identified and confirmed according to the **Unique ID**.

▶ **Reference Dye:**

- User can set the reference dye from the **Reference Dye** drop-down list.
- ▶ **Import Sample Information:** user can import sample information by clicking **Import Sample Information**.
- ▶ **Export Current Sample:** user can export current sample by clicking **Export Current Sample**.

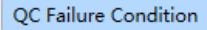
- ▶ **QC Failure Condition Setting:** after completing the sample well setting, please click  icon and the QC failure condition setting dialog box will pop up automatically, as shown in figure D-6.7.

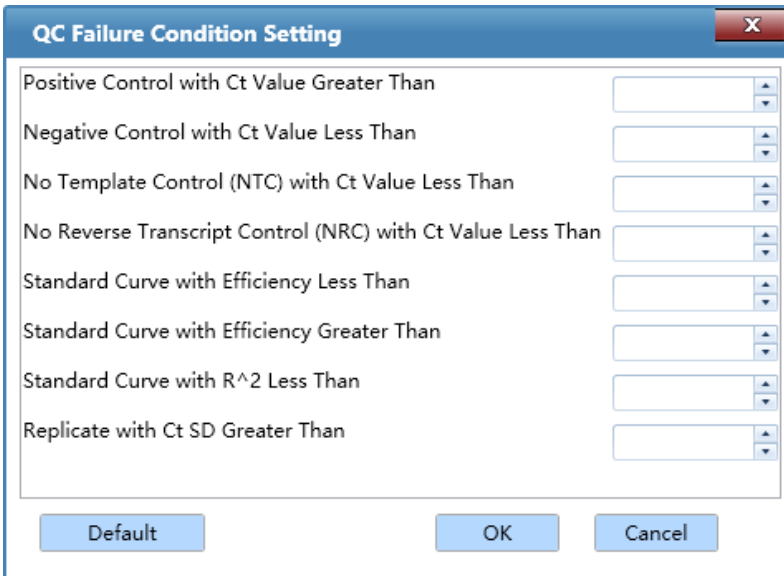

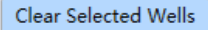

Figure D-6.7. Sample Setting Interface - QC Failure Condition Setting

- User can manually enter or use  and  keys to set the QC failure conditions, and click **< OK >** to confirm the setting.
 - User can click **< Default >** to clear all QC failure condition settings.
- ▶ **Clear Selected Wells:** user can click  icon to clear the relevant property settings for all selected wells.

3.3.3 Run Monitoring

After finishing the experiment run setting and sample setting, user can click **Run Monitoring** tab to enter the run monitoring interface, in order to start running the experiment and monitor the experiment running process, as shown in figure D-7.

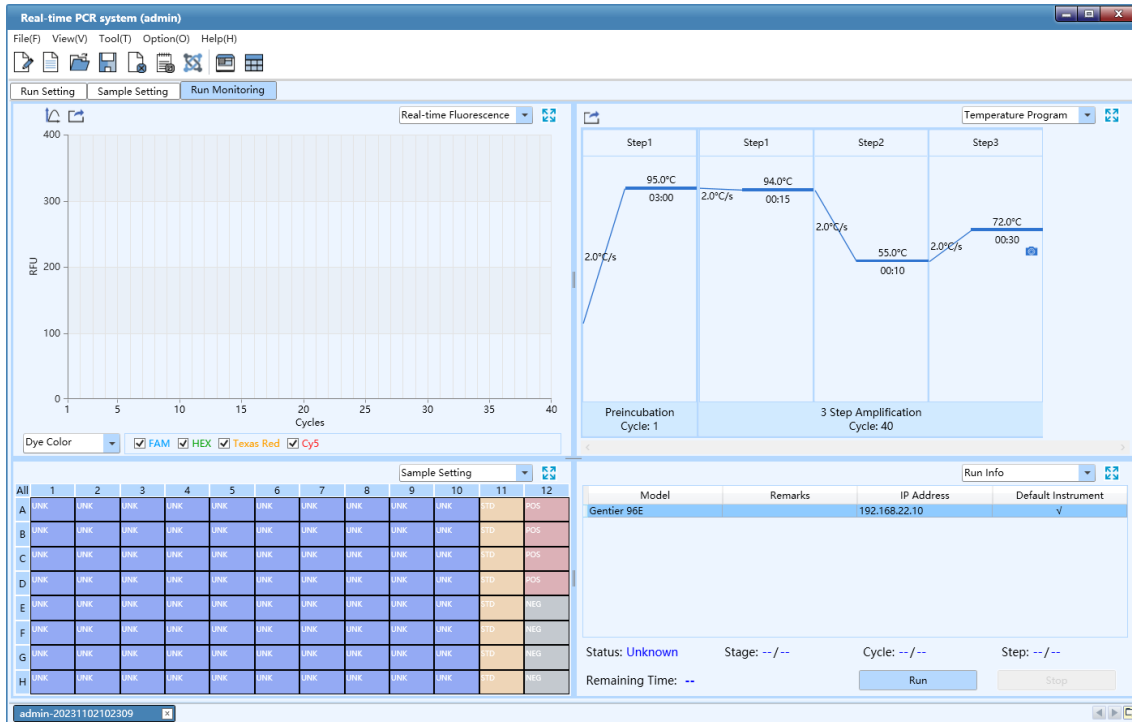



Figure D-7. Run Monitoring Interface

Interface Introduction and Parameter Description

The run monitoring interface consists of six functional modules: **Real-time Fluorescence**, **Temperature Program**, **Sample Setting**, **Run Info**, **Sample Info** and **Heat Map**; after entering the run monitoring interface. This interface is divided into four areas and the application software displays four functional modules (**Real-time Fluorescence**, **Temperature Program**, **Sample Setting**, **Run Info**) by default.

- Reminding:** user can select the functional module displayed on the run monitoring interface from the drop-down list on the top right corner of each area.
- Reminding:** user can click the  **Full Screen** icon on the top right corner of each area to display the current functional module of the area in full screen.
- Reminding:** user can click **Run** key in the **Run Info** functional module to run the current experiment and monitor the running state of current experiment on the run monitoring interface.

1. **Real-time Fluorescence:** displays the diagram of real-time fluorescence intensity against cycle number of the current running experiment, as shown in figure D-7.1.

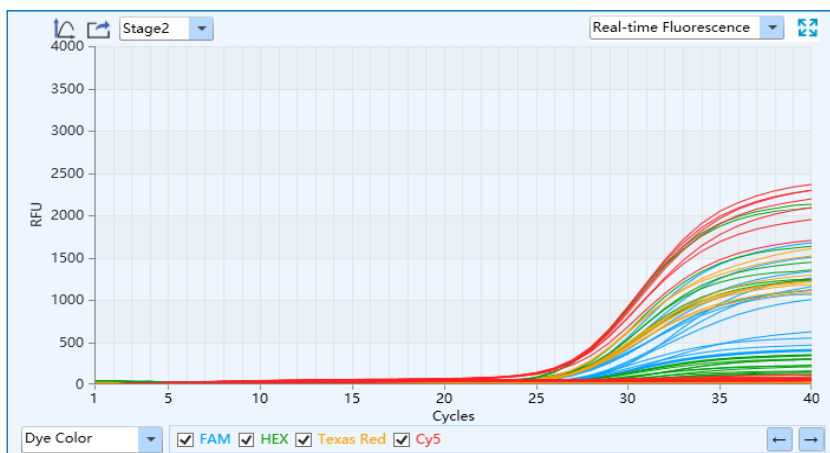





Figure D-7.1. Run Monitoring Interface - Real-time Fluorescence Function Module

- ▶ User can set fluorescence curve display mode from the drop-down list on the bottom left of **Real-time Fluorescence** functional module. The real-time fluorescence curve can be displayed according to **Well Color**, **Dye Color**, **Sample Color** and **Gene Color**.
- ▶ <  **Y-axis Coordinate Adjustment** >: user can adjust the Y-axis coordinate of the real-time fluorescence monitoring diagram. Please click <  **Y-axis Coordinate Adjustment** > icon and the coordinate range setting box will pop up automatically, as shown in figure D-7.1a. User can select **Automatic** or **Manual** option in the coordinate range setting box to set the Y-axis coordinate. If the **Automatic** option is selected, the application software will automatically adjust the Y-axis coordinate according to the detected fluorescence value; if the **Manual** option is selected, user can manually enter or use  and  keys to set the maximum and minimum value of Y-axis coordinate range in the **Maximum** and **Minimum** input box and click < **OK** > to confirm.

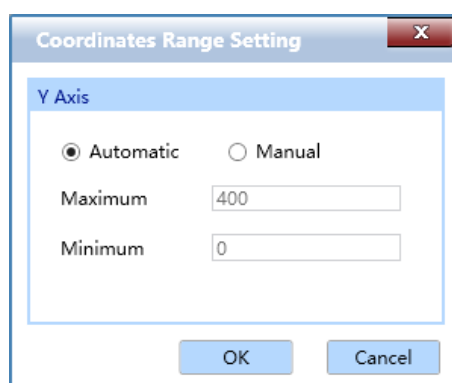



Figure D-7.1a. Run Monitoring Interface - Coordinate Range Setting

- ▶ <  **Export** >: user can click <  **Export** > icon to export the current real-time fluorescence monitoring diagram.
- 2. **Temperature Program**: display the temperature program of the current running experiment, as shown in figure D-7.2

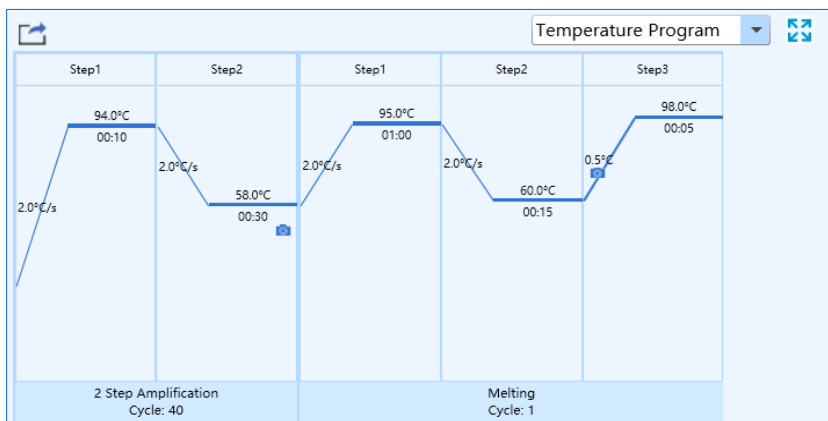



Figure D-7.2. Run Monitoring Interface - Temperature Program Function Module

- ▶ **Parameter introduction**: same with the parameters introduced in *D-3.3.1 Run Setting - Temperature program area*.
- ▶ **Function key introduction**: user can click <  **Export** > icon to export the temperature program monitoring diagram of the current experiment.
- 3. **Sample Setting**: display the sample well setting of the current running experiment, as shown in figure D-7.3.

Sample Setting												
All	1	2	3	4	5	6	7	8	9	10	11	12
A	UNK	UNK	UNK	UNK	UNK	UNK	UNK	UNK	UNK	UNK	STD	POS
B	UNK	UNK	UNK	UNK	UNK	UNK	UNK	UNK	UNK	UNK	STD	POS
C	UNK	UNK	UNK	UNK	UNK	UNK	UNK	UNK	UNK	UNK	STD	POS
D	UNK	UNK	UNK	UNK	UNK	UNK	UNK	UNK	UNK	UNK	STD	POS
E	UNK	UNK	UNK	UNK	UNK	UNK	UNK	UNK	UNK	UNK	STD	NEG
F	UNK	UNK	UNK	UNK	UNK	UNK	UNK	UNK	UNK	UNK	STD	NEG
G	UNK	UNK	UNK	UNK	UNK	UNK	UNK	UNK	UNK	UNK	STD	NEG
H	UNK	UNK	UNK	UNK	UNK	UNK	UNK	UNK	UNK	UNK	STD	NEG

Figure D-7.3. Run Monitoring Interface - Sample Setting Function Module

- ▶ **Parameter introduction:** same with the parameters introduced in *D-3.3.2 Sample Setting - Sample Setting area*.
 - ▶ **Function key introduction:** user can select one or more sample wells in the sample setting function module to display the corresponding fluorescence curve and relevant data in the *Real-time Fluorescence* and *Sample Info* function modules.
4. **Run Info:** display the current instrument information and the real-time running status, such as the *Stage*, *Step*, *Cycle* and *Remaining Time* of the current experiment, as shown in figure D-7.4.

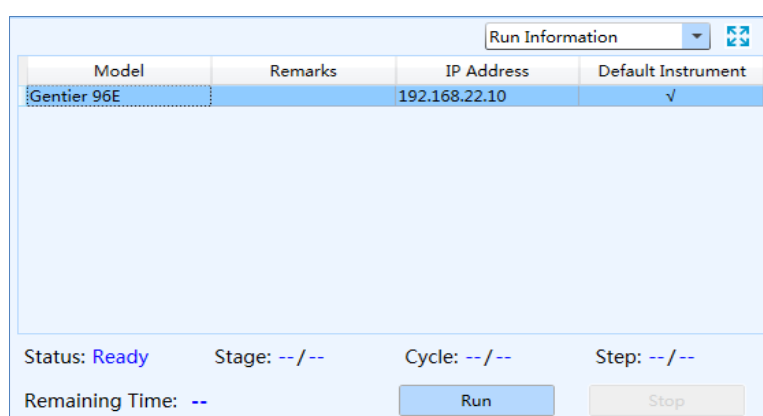

Figure D-7.4. Run Monitoring Interface - Run Info Function Module

- ▶ **Function key introduction:**
 - User can click **< Run >** key to run the current experiment;
 - User can click **< Stop >** key to stop the current experiment;
5. **Sample Info:** display the detailed sample information of the current running experiment, as shown in figure D-7.5.

Well	Sample	Test Name	Gene	Sample Type	Dye	Replicate
A1				Unknown	FAM	
A2				Unknown	FAM	
A3				Unknown	FAM	
A4				Unknown	FAM	
A5				Unknown	FAM	
A6				Unknown	FAM	
A7				Unknown	FAM	
A8				Unknown	FAM	
A9				Unknown	FAM	

Figure D-7.5. Run Monitoring Interface - Sample Info Function Module

6. **Heat Map:** display the real-time fluorescence heat map of the current running experiment, as shown in figure D-7.6.

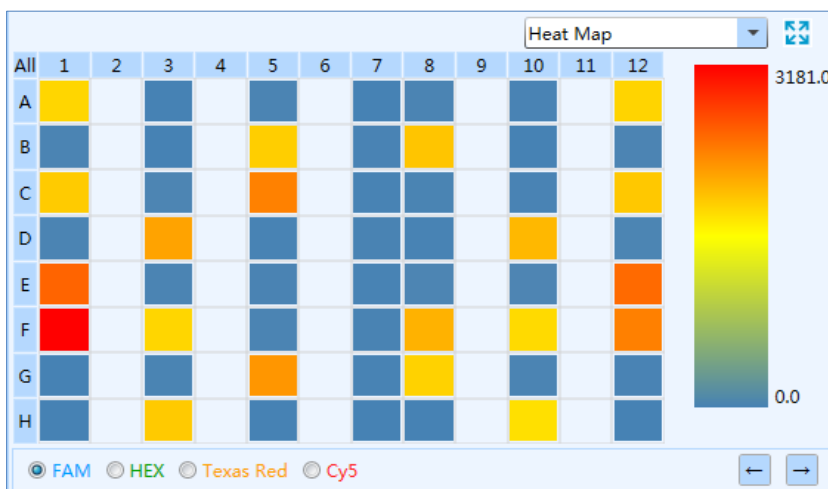



Figure D-7.6. Run Monitoring Interface - Heat Map Function Module

3.3.4 Analysis

After experiment running, user can click the **Analysis** tab to enter the analysis interface. According to the experiment settings and requirements, user shall first select the suitable data analysis method for the current experiment on this interface.

- ▶ User can click <  **New Analysis** > icon in Tool Bar and the application software will automatically pop up the new analysis window, as shown in figure D-8.

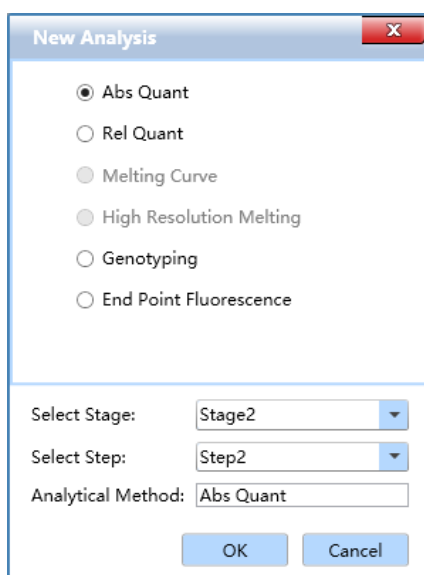

Figure D-8. New Analysis Window

- ▶ The application software provides user with six analysis methods: ***Abs Quant***, ***Rel Quant***, ***Melting Curve***, ***High Resolution Melting***, ***Genotyping*** and ***End Point Fluorescence***.
 - ***Select Stage***: user can choose the stages that need to be analyzed.
 - ***Select Step***: user can choose the step that need to be analyzed.
 - ***Analytical Method***: shown the current analytical method for the current step/stage.
 - User can choose the relevant data analysis method and click **< OK >** to confirm.

3.3.4.1 Abs Quant

The absolute quantification experiment is intended to quantify the amount of an interest nucleic acid. Samples with unknown initial nucleic acid quantities are amplified as well as a dilution series of gene-specific standard samples with known concentrations. The measured Ct values of the standard samples are plotted against their known concentrations to obtain a regression line named standard curve. The initial nucleic acid quantities of the samples can be obtained by plotting their Ct values on the standard curve.

The relative quantification analysis interface consists of seven functional modules: ***Amplification Curve***, ***Standard Curve***, ***Sample Setting***, ***Result Table***, ***Raw Curve***, ***Raw Fluorescence*** and ***Heat Map***. The relative quantification analysis interface is divided into four areas. When user enter the analysis interface, the application software displays four functional modules (***Amplification Curve***, ***Standard Curve***, ***Sample Setting***, ***Result Table***) by default, as shown in figure D-9.

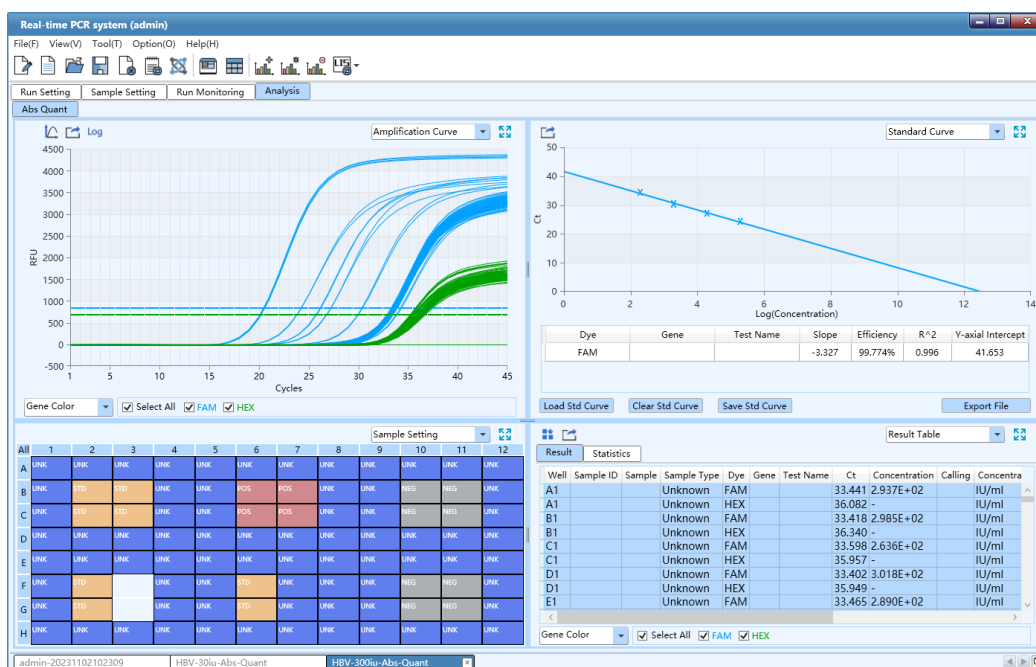



Figure D-9. Absolute Quantification Analysis Interface

- ❗ **Reminding:** user can select the functional module displayed on the analysis interface from the drop-down list on the top right corner of each area.
- ❗ **Reminding:** user can click the <  **Full Screen** > icon on the top right corner of each area to display the current functional module in full screen.

Interface Introduction and Parameter Description

- I. **Amplification Curve:** display the diagram of fluorescence intensity against cycle number of the current experiment, as shown in figure D-9.1.

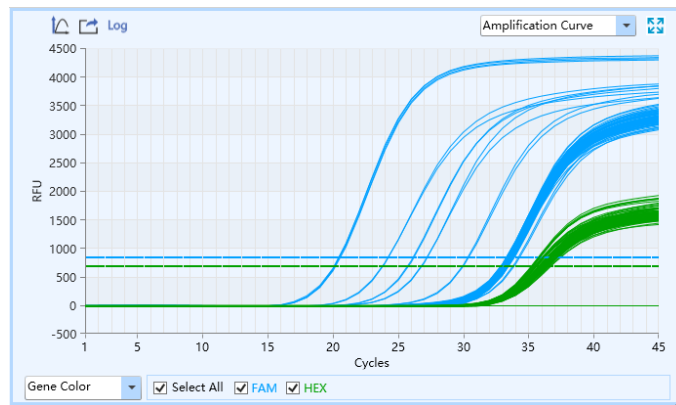





Figure D-9.1. Abs Quant Analysis Interface - Amplification Curve Functional Module

► Parameter introduction:

- X axis represents the cycle number of the current experiment;
- Y axis represents the Relative Fluorescence Unit (RFU);

► Function key introduction:

- User can select the amplification curve display mode from the drop-down list on the bottom left of **Amplification Curve** functional module. The amplification curve can be displayed according to **Well Color**, **Dye Color**, **Sample Color** and **Gene Color**.
- <  **Y-axis Coordinate Adjustment** >: user can adjust the Y-axis coordinate of the amplification curve diagram. Please click <  **Y-axis Coordinate Adjustment** > icon and the coordinate range setting box will pop up automatically, as shown in figure D-9.1a. User can select **Automatic** or **Manual** option in the coordinate range setting box to set the Y-axis coordinate. If the **Automatic** option is selected, the application software will automatically adjust the Y-axis coordinate according to the detected fluorescence value; if the **Manual** option is selected, user can manually enter or use  and  keys to set the maximum

and minimum value of Y-axis coordinate range in the **Maximum** and **Minimum** input box and click < **OK** > to confirm.

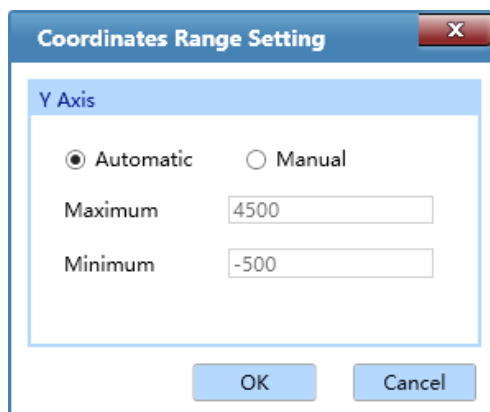





Figure D- 9.1a. Abs Quant Analysis Interface - Coordinate Range Setting

- ▶ <  **Export** >: user can click <  **Export** > icon to export the current amplification curve diagram.
- ▶ <  **Log View** >: user can click <  **Log View** > icon to view the log image of the amplification curve diagram.
- ⓘ **Reminding**: user can hover the mouse over a certain amplification curve, the curve will be highlighted and its corresponding channel and well coordinate will be displayed on the right of cursor.

- II. Standard Curve**: displays the threshold Ct value against the initial nucleic acid quantity of each standard sample, as shown in figure D-9.2. For absolute quantification, the standard curve is used to assign initial nucleic acid quantities to unknown samples.

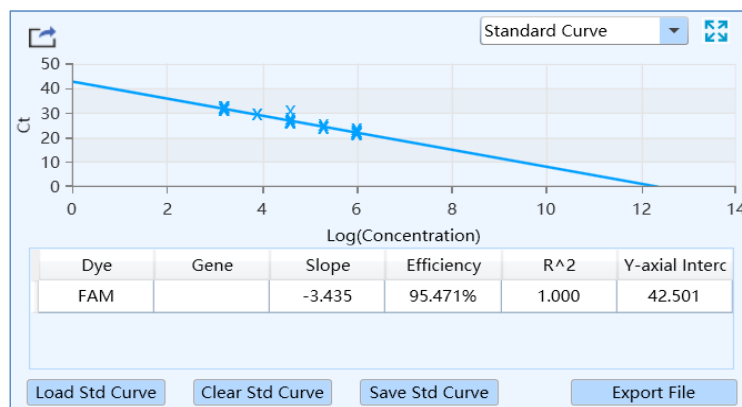

Figure D-9.2. Abs Quant Analysis Interface - Standard Curve Functional Module

► **Parameter introduction:**

- X axis represents the log concentration of samples;
- Y axis represents the threshold Ct value;
- **Dye**: display the relevant dye of standard curve;
- **Target Gene**: display the target gene of standard curve;
- **Slope**: display the slope of standard curve;
- **Efficiency**: display the amplification efficiency of standard curve;
- **R²**: display the linear regression coefficient square value of standard curve;
- **Y-axis intercept**: display the Y-axis intercept of standard curve;

► **Function key introduction:**

- **< Load Std Curve >**: click **< Load Std Curve >** and the application software will automatically pop up the standard curve window, which consists of **Import Standard Curve**, **Select Standard Curve** and **Standard Curve Preview** three parts, as shown in figure D-9.2a.

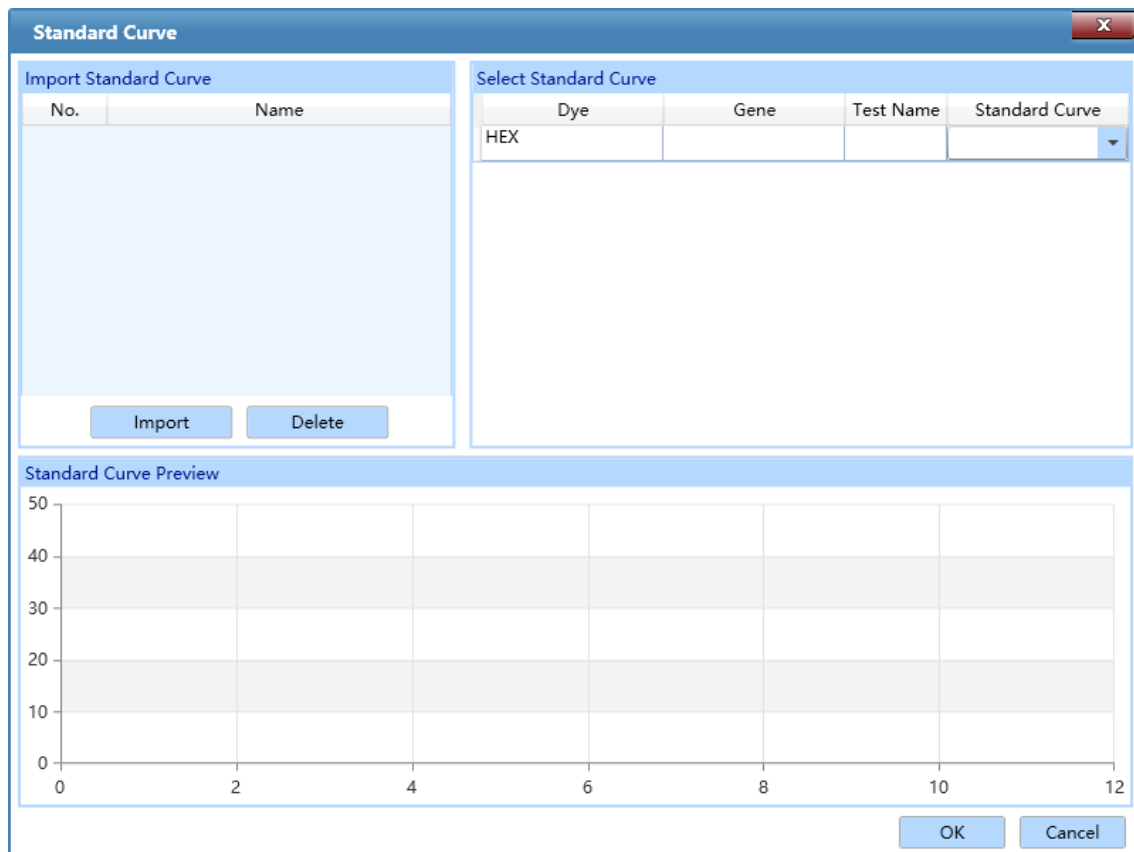



Figure D- 9.2a. Abs Quant Analysis Interface - Standard Curve Window

- a. **Import Standard Curve:** user can click < **Import** > key and select a saved standard curve file, then import it to the standard curve list. The corresponding standard curve diagram will be displayed in the **Standard Curve Preview** area below.
- b. **Select Standard Curve:** user can call one or more standard curve from the selected standard curve file according to the current experiment requirements. Please select a standard curve which corresponds to the current experiment setting from the **Standard Curve** drop-down list, and click < **OK** > at the bottom of Standard Curve window to load the selected standard curve to the standard curve functional module.
- c. **Standard Curve Preview:** display the preview of selected standard curve to be loaded.
- < **Clear Std Curve** >: user can click < **Clear Std Curve** > to clear the standard curve displayed on the Standard Curve functional module.
- < **Save Std Curve** >: user can click < **Save Std Curve** > and enter a name in the enter name dialog box for the standard curve file to save; click < **OK** > to confirm, as shown in figure D-9.2b.



Figure D- 9.2b. Abs Quant Analysis Interface - Enter Name Dialog Box

- < **Export File** >: user can click < **Export File** > to export the current standard curve file to a designated save path.
 - <  **Export** >: user can click <  **Export** > icon to export the current standard curve diagram.
- III. **Sample Setting:** display the well setting of the current experiment, as shown in figure D-9.3.
- ▶ **Parameter introduction:** same with the parameters and operations introduced in [D-3.3.2 Sample Setting - Sample Setting area](#).
 - ▶ **Function key introduction:** user can click the relevant well in the sample setting area to display the corresponding amplification curve and data in the **Amplification Curve** and **Sample Info** functional modules.

	1	2	3	4	5	6	7	8	9	10	11	12
A	UNK	UNK	UNK	UNK	UNK	UNK	UNK	UNK	UNK	UNK	UNK	UNK
B	UNK	STD	STD	UNK	UNK	POS	POS	UNK	UNK	NEG	NEG	UNK
C	UNK	STD	STD	UNK	UNK	POS	POS	UNK	UNK	NEG	NEG	UNK
D	UNK	UNK	UNK	UNK	UNK	UNK	UNK	UNK	UNK	UNK	UNK	UNK
E	UNK	UNK	UNK	UNK	UNK	UNK	UNK	UNK	UNK	UNK	UNK	UNK
F	UNK	STD		UNK	UNK	STD	UNK	UNK	UNK	NEG	NEG	UNK
G	UNK	STD		UNK	UNK	STD	UNK	UNK	UNK	NEG	NEG	UNK
H	UNK	UNK	UNK	UNK	UNK	UNK	UNK	UNK	UNK	UNK	UNK	UNK

Figure D-9.3. Abs Quant Analysis Interface - Sample Setting Functional Module

IV. Result Table: display the sample details and result data of the current experiment. The result table functional module consists of **Result** and **Statistics** sub-tabs.

- ▶ The **Result** sub-tab is selected by default on the result table functional module, which display the sample details and results of the current experiment, as shown in figure D-9.4a.

Well	Sample ID	Sample	Sample Type	Dye	Gene	Test Name	Ct	Concentration	Calling	Concentra
A1			Unknown	FAM			33.441	2.937E+02		IU/ml
A1			Unknown	HEX			36.082	-		IU/ml
B1			Unknown	FAM			33.418	2.985E+02		IU/ml
B1			Unknown	HEX			36.340	-		IU/ml
C1			Unknown	FAM			33.598	2.636E+02		IU/ml
C1			Unknown	HEX			35.957	-		IU/ml
D1			Unknown	FAM			33.402	3.018E+02		IU/ml
D1			Unknown	HEX			35.949	-		IU/ml
E1			Unknown	FAM			33.465	2.890E+02		IU/ml

Figure D-9.4a. Result Table Functional Module – Result Sub-tab

- User can double click the title of each column to sort all sample results according to the content in this column.
- User can click the title of each column and drag the column to the left or right, in order to adjust the sequence of sample results.
- ▶ User can click **Statistics** sub-tab to view the statistical results of the current experiment, as shown in figure D-9.4b.

Replicate	Well	Sample	Sample Type	Dye	Gene
	A1		Standard	FAM	
4	A3,A10,C8,D1,D12,F5,H1,H12		Unknown	Cy5	
2	A5,B1,B12,D8,E5,G3,G10,H8		Unknown	HEX	
3	A8,B3,B10,D5,E8,G1,G12,H5		Unknown	Texas Red	
1	A12,C5,D3,D10,E1,E12,F8,H3,H10		Unknown	FAM	
	B5		Standard	FAM	
	B8		Unknown	FAM	
	C1		Unknown	FAM	
	C12		Unknown	FAM	

Gene Color: Select All FAM HEX Texas Red Cy5

Figure D-9.4b. Result Table Functional Module– Statistics Sub-tab

- < **Table Management** >: click < **Table Management** > and the table management window will automatically pop up, as shown in figure D-9.4c. User can decide to **Display** or **Hide** the corresponding content(s) in the result table by checking its'/their check box(s).

No.	Column Name	Display / Hide
1	Well	<input checked="" type="checkbox"/>
2	Sample ID	<input checked="" type="checkbox"/>
3	Sample	<input checked="" type="checkbox"/>
4	Sample Type	<input checked="" type="checkbox"/>
5	Dye	<input checked="" type="checkbox"/>
6	Gene	<input checked="" type="checkbox"/>
7	Test Name	<input checked="" type="checkbox"/>
8	Ct	<input checked="" type="checkbox"/>
9	Concentration	<input checked="" type="checkbox"/>
10	Endpoint Fluor	<input type="checkbox"/>
11	Calling	<input checked="" type="checkbox"/>
12	Concentration Unit	<input checked="" type="checkbox"/>
13	Standard Conc.	<input checked="" type="checkbox"/>
14	Reference Dye	<input checked="" type="checkbox"/>

OK Cancel

Figure D-9.4c. Result Table Functional Module – Table Management

- < **Export Excel** >: user can click < **Export Excel** > to export the result of the current experiment as an excel file.

- The result data can be displayed according to **Dye Color**, **Sample Color** and **Gene Color**. User can select the display mode from the drop-down list at the bottom left of **Result** functional module.
- V. **Raw Curve**: display the diagram of raw amplification curve without subtract baseline, as shown in figure D-9.5. The parameters and function keys of raw curve functional module are same with those of amplification curve functional module.

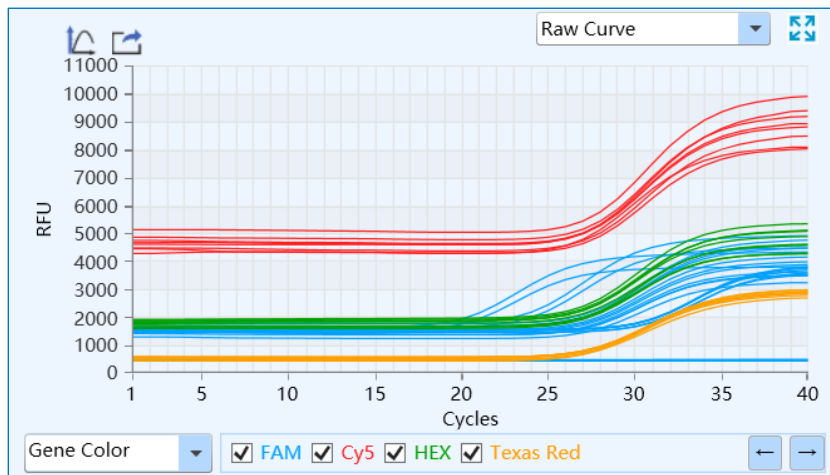

Figure D-9.5. Abs Quant Analysis Interface - Raw Curve Functional Module

- VI. **Raw Fluorescence**: display the raw fluorescence data map of the current experiment, as shown in figure D-9.6.

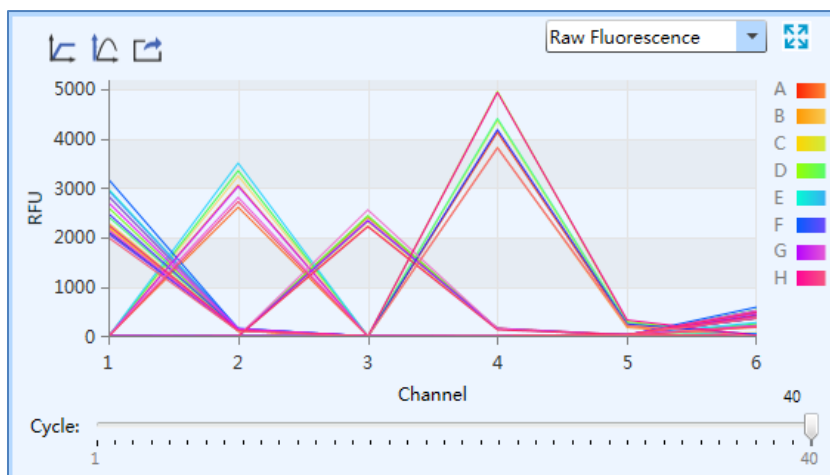



Figure D-9.6. Abs Quant Analysis Interface - Raw Fluorescence Functional Module

► **Parameter introduction:**

- X axis shows channel 1-6 (Gentier 96E&96T) or channel 1-4 (Gentier 96R).
- Y axis shows the relative fluorescence unit ((RFU).
- Different colors represent A-H rows of sample wells.

► **Function key introduction:**

- User can slide the **Cycle** slider at the bottom of raw fluorescence functional module to view the raw fluorescence value of different wells at different cycles.
- <  **Y-axis Coordinate Adjustment** > and <  **Export** > keys are same with those of amplification curve functional module.

VII. Heat Map: display the **Ct**, **Concentration**, **Fluorescence** heat map and QC diagram of the current experiment, as shown in figure D-9.7.

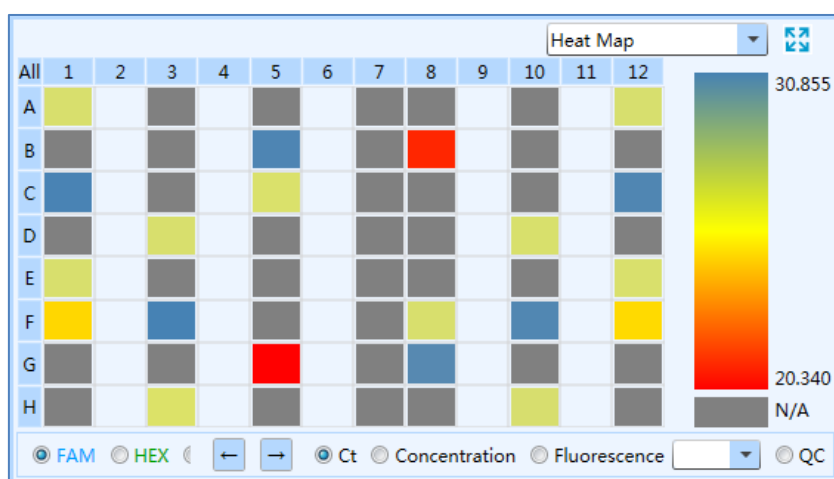



Figure D-9.7. Abs Quant Analysis Interface – Heat Map Functional Module

- **Ct:** user can check **Ct** option and click any dye to view the relevant Ct heat map.
- **Concentration:** user can select **Concentration** option and click any dye to view the relevant concentration heat map.
- **Fluorescence:** user can select **Fluorescence** option and select the cycle number from drop-down list; then click any dye to view the relevant fluorescence heat map at certain cycle.
- **QC:** user can select **QC** option, and if a certain sample or reference conforms to the QC failure condition set on the Sample Setting interface, then the relevant sample well will be displayed as **N/A** on QC diagram.

Abs Quant Analysis Setting

User can click the <  **Analysis Setting** > icon in the Tool Bar and the application software will automatically pop up the analysis setting window, which is composed of **Amplification Plot** and **Gene and Sample** two tabs. User can set corresponding parameters for the current experimental

data analysis method in the analysis setting window.

I. Amplification Plot tab: user can set the **Analysis Mode** and **Analysis Method** of the current experiment within the **Amplification Plot** tab, as shown in figure D-10.1.

The screenshot shows the 'Analysis Setting' window with the 'Amplification Plot' tab selected. The window is divided into several sections:

- Analysis Mode:** Includes checkboxes for 'Reference Dye', 'Isothermal', 'Baseline Gain Calibration' (checked), 'Hypersensitive', 'Reverse Curve', and 'Fluorescence Drift Correction'.
- Baseline:** Features a 'Baseline' section with 'All Selected Rows: Start Cycle:' and 'End Cycle:' dropdowns, and a 'Restore' button. Below this is a table for baseline settings.





Well	Dye	Automatic Baseline		Manual Baseline	
		Start Cycle	End Cycle	Start Cycle	End Cycle
A7	HEX	5	29	5	29
A8	FAM	2	28	2	28
A8	HEX	5	29	5	29
A9	FAM	2	28	2	28
A9	HEX	5	29	5	29
A10	FAM	5	28	5	28
A10	HEX	5	29	5	29
A11	FAM	2	28	2	28
A11	HEX	5	29	5	29
- Analytical Method:** Includes radio buttons for 'Auto Threshold', 'Manual Threshold' (selected), and 'Normalization Method', along with a 'Restore' button. Below this is a table of threshold values.

Dye	Gene	Test Name	Auto Threshold	Manual Threshold
FAM			517.78	829.96
HEX			250.87	676.77

At the bottom of the window are 'OK' and 'Cancel' buttons.

Figure D-10.1. Abs Quant Analysis Setting Interface - Amplification Plot Tab

- ▶ **Analysis Mode:** user can check the analysis mode check box of **Reference Dye** and **Baseline Gain Calibration** according to the experiment requirements, and set the corresponding parameters in the **Baseline** list.
 - a. **Reference Dye:** If user had set the reference dye in the Sample Setting tab according to the experiment requirements, user can check the check box of **Reference Dye** for experiment data analysis.
 - b. **Baseline Gain Calibration:** in general conditions, the application software select the **Baseline Gain Calibration** analysis mode by default, which provides user with **Automatic Baseline** and **Manual Baseline** two baseline setting methods.
 - User can click the **Automatic Baseline** option, the application software will automatically set the baseline for amplification curve, and shown the **Start Cycle** and **End Cycle** of the automatic baseline setting in the columns of the **Baseline** list.

- User can also click the **Manual Baseline** option, select one well in the **Baseline** list, use  and  keys to manually set the **Start Cycle** and **End Cycle** of the baseline setting for this sample; or choose multiple wells and set the **Start Cycle** and **End Cycle** for **All Selected Rows** on top of the **Baseline** list.
 - User can click **< Restore >** on the top right corner of **Baseline** list to restore the **Start Cycle** and **End Cycle** of the automatic baseline setting.
- c. Reverse Curve:** in order to analysis the amplification curves of some special detection reagents, user can check the check box of **Reverse Curve** analysis mode to vertically reverse the amplification curve.
- d. Isothermal:** for isothermal amplification experiment, user can check the check box of **Isothermal** analysis mode to analysis the isothermal amplification experiment data.
- e. Hypersensitive:** for amplification experiments with high sensitivity requirements, user can check the check box of **Hypersensitive** analysis mode for experiment data analysis.
- f. Fluorescence Drift Correction:** for correcting the baseline drift, user can check the check box of **Fluorescence Drift Correction** to correct fluorescence drift.
- ▶ **Analytical Method:** the application software provides user with two Ct value analytical methods: **Auto Threshold**, **Manual Threshold** and **Normalization Method**.
- a.** User can click **Auto Threshold** option, the application software will automatically set and show the threshold value for all dyes in its column.
- b.** User can also click **Manual Threshold** option, select one fluorescein and use  and  keys to set the manual threshold value in its column.
- c.** User can click **< Restore >** on the top right corner of threshold list to restore the **Auto Threshold** settings.
- d.** User can click **Normalization Method** option and the application software will automatically calculate the Ct value according to the normalization value of amplification curve.
- II. Gene and Sample tab:** user can set the dye, gene and sample required for the analysis of the current experiment within the gene and sample tab, as shown in figure D-10.2.
- ▶ **Dye and Gene:** display the name of target gene and its marking dye.
- a.** User can check a certain check box in the **Remove** column and click **< OK >** to remove the experiment data of the selected target gene and its marking dye.
- b.** Click **< Cancel >** to cancel operation and return to the analysis interface.
- ▶ **Sample:** display all the sample name of sample setting.

- a. User can check a certain check box in the **Remove** column and click < **OK** > to remove the experiment data of the selected sample name.
- b. Click < **Cancel** > to cancel operation and return to the analysis interface.

Analysis Setting				
Amplification Plot		Gene and Sample		
Dye and Gene				
No.	Dye	Gene	Test Name	Remove
1	FAM			<input type="checkbox"/>
2	HEX			<input type="checkbox"/>
Sample				
No.	Sample	Remove		
1		<input type="checkbox"/>		
		OK		Cancel

Figure D-10.2. Abs Quant Analysis Setting Interface – Gene and Sample Tab

3.3.4.2 Rel Quant

The relative quantification experiment aims to compare the expression level of two or more genes within a same individual. Usually, endogenous housekeeping genes with constant expression level are taken as the internal reference genes. The relative quantification is realized by measuring the changes of the target genes expression level related to the internal reference genes.

The relative quantification analysis interface consists of eight functional modules: **Amplification Curve**, **Bar Chart**, **Sample Setting**, **Result Table**, **Standard Curve**, **Raw Curve**, **Raw Fluorescence** and **Heat Map**. This interface is divided into four areas and the application software displays four functional modules (**Amplification Curve**, **Bar Chart**, **Sample Setting**, **Result Table**) by default, as shown in figure D-11.

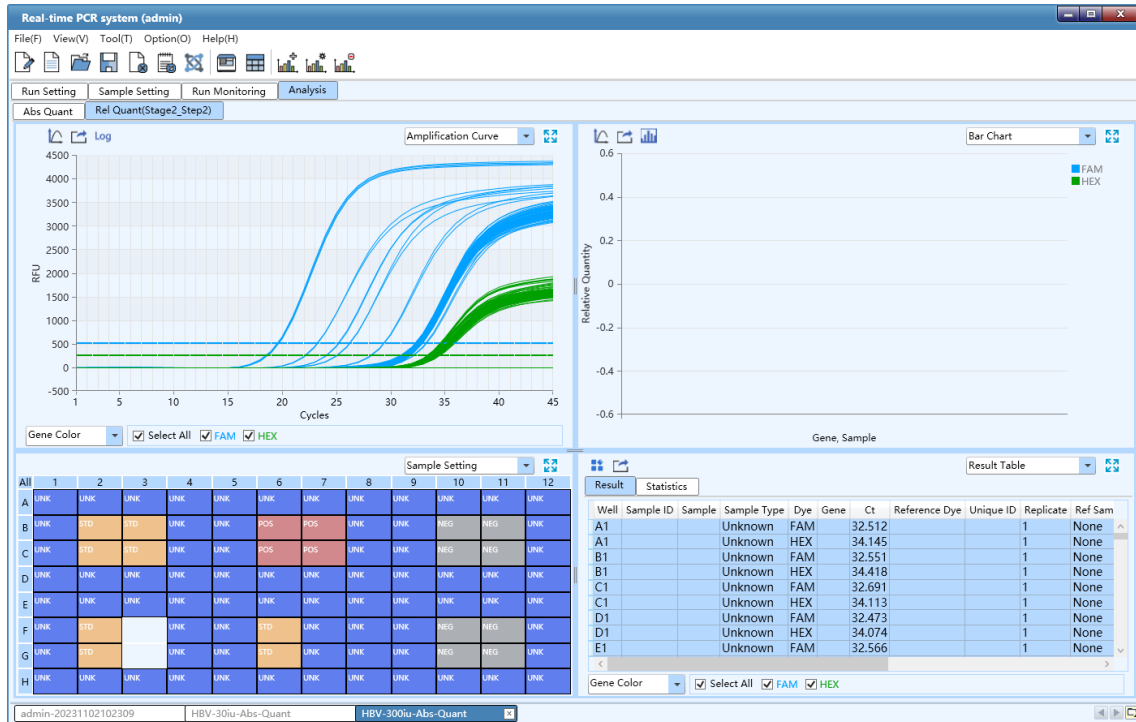

Figure D-11. Relative Quantification Analysis Interface

Interface Introduction and Parameter Description

⚠ Reminding: the parameter descriptions of *Amplification Curve*, *Sample Setting*, *Result Table*, *Standard Curve*, *Raw Curve*, *Raw Fluorescence* and *Heat Map* functional modules are same with those introduced in *D-3.3.4.1 Abs Quant*.

I. Bar Chart: display the relative ratio relationship between target gene & sample and reference gene & sample, as shown in figure D-11.1.

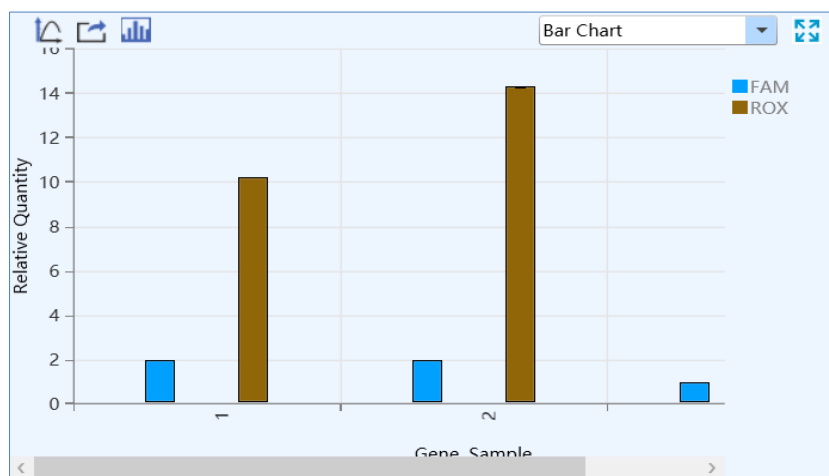





Figure D-11.1. Rel Quant Analysis Interface - Bar Chart Function Module

► **Parameter introduction:**

- X axis shows the gene and sample for comparison;
- Y axis shows the **Relative Quantity** ratio of the compared gene and sample;

❗ **Reminding:** the application software set the relative quantity ratio of the reference sample to 1 by default.

► **Function key introduction:**

- The introduction of <  **Y-axis Coordinate Adjustment** > and <  **Export** > keys are same with those keys introduced in [D-3.3.4.1 Abs Quant - Amplification Curve](#).
- <  **Display Setting** >: user can click <  **Display Setting** > icon and the application software will automatically pop up the display setting window, as shown in figure D-11.2.

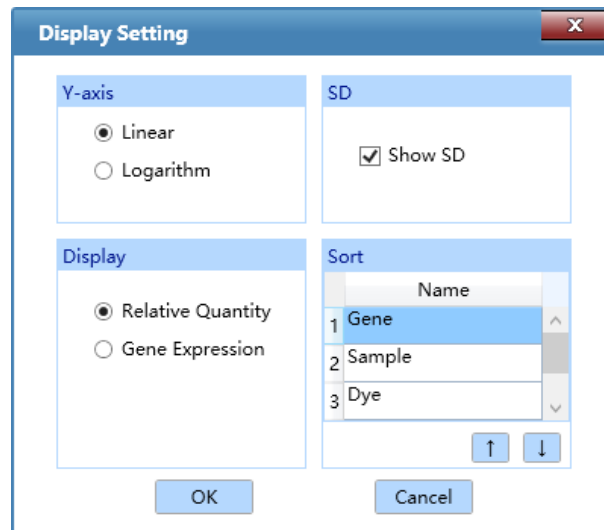



Figure D-11.2. Rel Quant Interface - Display Setting Window

- Y axis:** If user select **Linear** option, the **Bar Chart** functional module will display the linear coordinates of Y axis; if user select **Logarithm** option, the **Bar Chart** functional module will display the logarithm coordinates of Y axis.
- Display:** user can set the display mode of **Bar Chart** functional module. If user select **Relative Quantity** option, the **Bar Chart** functional module will display the relative quantity ratio of the target gene and reference gene; if user select **Gene Expression** option, the **Bar Chart** functional module will display the relative quantity ratio of target gene & sample and reference gene & sample.
- SD:** user can check **Show SD** check box to display the SD value on **Bar Chart** functional module.

d. **Sort:** User can use  and  keys to set the display sort order of **Bar Chart** functional module, including **Sample, Dye** or **Gene**.

Rel Quant Analysis Setting

After entering the relative quantification analysis interface, the application software will automatically pop up the analysis setting window, which consists of **Gene and Sample, Amplification Plot** two tabs. User can set the relevant parameters for current relative quantification analytical method in the analysis setting window.

I. **Amplification Plot** tab: the introduction of relevant parameters and function keys is same with those introduced in **D-3.3.4.1 Abs Quant - Abs Quant Analysis Setting**.

II. **Gene and Sample** tab: user can set the dye, gene, sample and reference required for the analysis of the current experiment within the gene and sample tab, as shown in figure D-12.

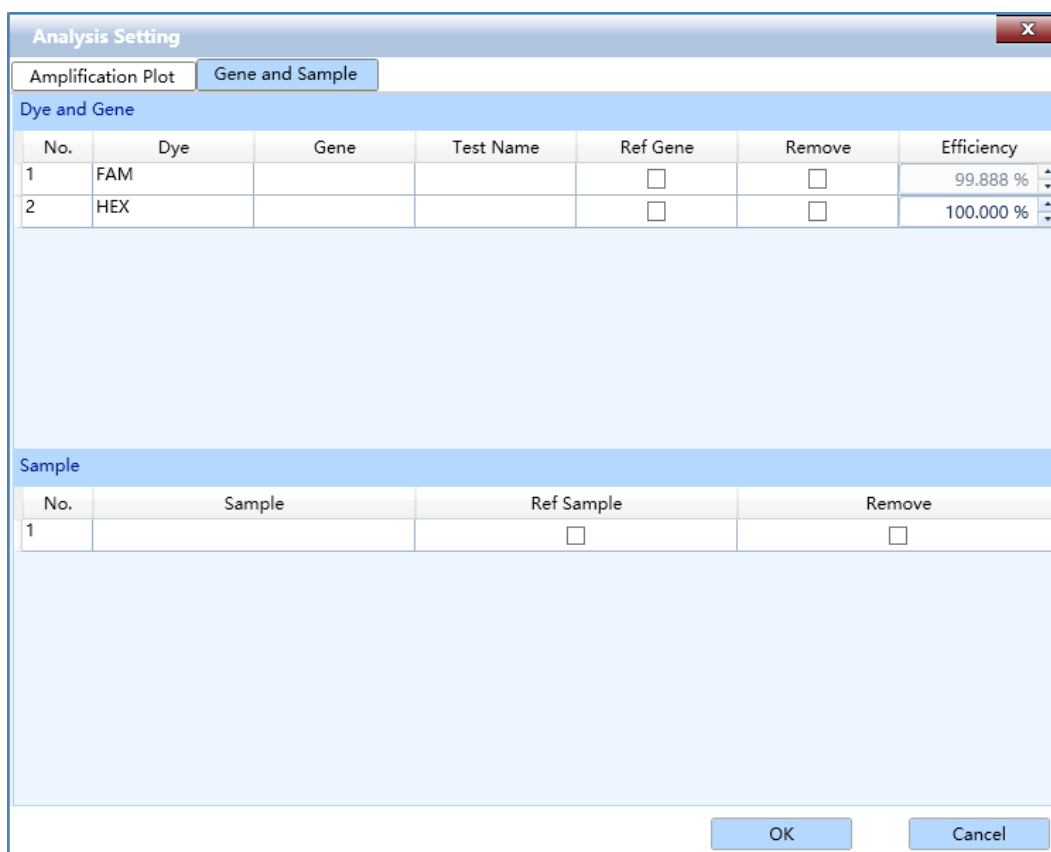



Analysis Setting							
Amplification Plot		Gene and Sample					
Dye and Gene							
No.	Dye	Gene	Test Name	Ref Gene	Remove	Efficiency	
1	FAM			<input type="checkbox"/>	<input type="checkbox"/>	99.888 %	
2	HEX			<input type="checkbox"/>	<input type="checkbox"/>	100.000 %	
Sample							
No.	Sample	Ref Sample	Remove				
1		<input type="checkbox"/>	<input type="checkbox"/>				
				OK	Cancel		

Figure D-12. Rel Quant Analysis Setting Interface - Gene and Sample Tab

► **Dye and Gene:** display the name of target gene and its marking dye.

a. User can check a certain check box in **Ref Gene** column and click **< OK >** to set the reference

gene of the current experiment.

- b. User can check a certain check box in **Remove** column and click < **OK** > to remove the experiment data of corresponding dye labeled genes from the Analysis interface.
- c. User can click a certain **Efficiency** column, use  and  keys to set the amplification efficiency of the corresponding dye labeled gene.

 **Reminding:** if a standard curve has obtained for the current experiment, the application software will automatically load the amplification efficiency of the standard curve.

► **Sample:** display all the sample name of sample setting.

- a. User can check a certain check box in **Ref Sample** column and click < **OK** > to set the reference sample of the current experiment.
- b. User can check a certain check box in **Remove** column and click < **OK** > to remove the experiment data of samples with corresponding sample name from the relative quantification analysis interface.

3.3.4.3 Melting Curve

For intercalating dyes (such as SYBR Green) and non-cleavable hybridization probes, the fluorescence intensity is proportional to the amount of double-strand DNA (dsDNA). Melting curve show that the melting degree of dsDNA varies with the rising temperature. Different dsDNA has different melting temperature T_m (the temperature at which, 50% of the DNA has dissociated from double-stranded to single-stranded) owing to different base sequence, fragment length and GC content. Therefore, the melting curve is usually used to analyze whether there are non-specific PCR products in PCR products.

The melting curve analysis interface consists of five functional modules: **Melting Curve**, **Melting Peak**, **Sample Setting**, **Result Table** and **Heat Map**. The melting curve analysis interface is divided into four areas, the application software displays four functional modules (**Melting Curve**, **Melting Peak**, **Sample Setting**, **Result Table**) by default, as shown in figure D-13.

 **Reminding:** the parameter descriptions of **Sample Setting**, **Result Table** and **Heat Map** functional modules are same with those introduced in [D-3.3.4.1 Abs Quant](#).

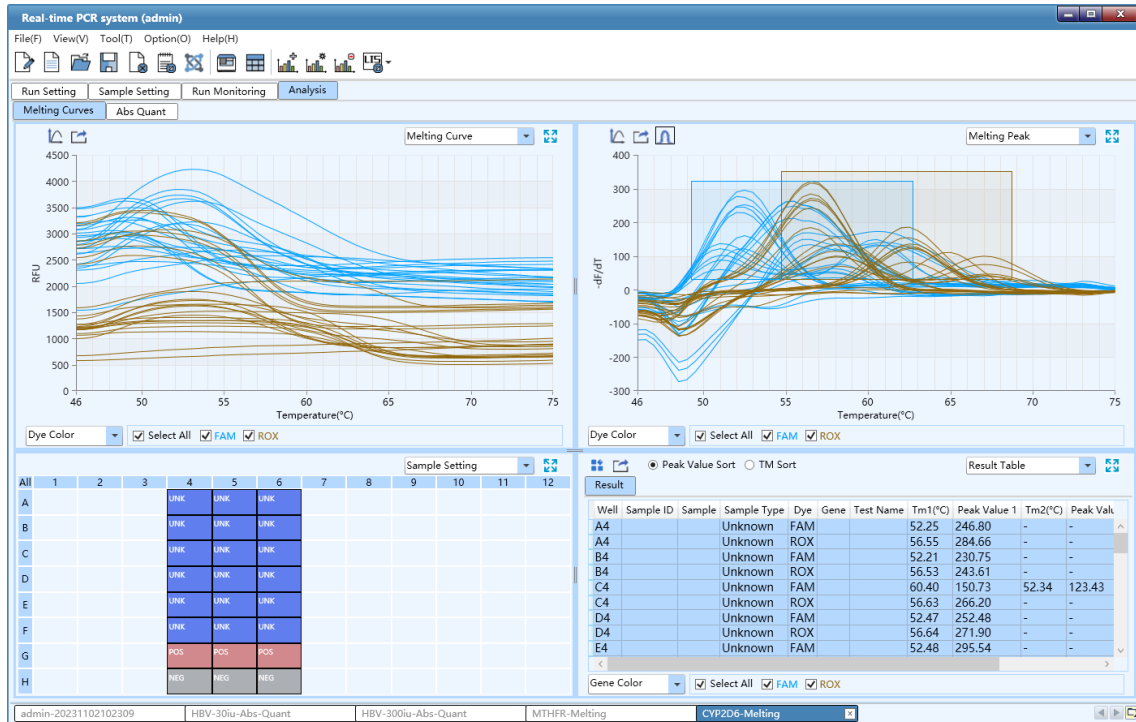

Figure D-13. Melting Curve Analysis Interface

Interface Introduction and Parameter Description

I. Melting Curve: display the fluorescence intensity against the temperature, as shown in figure D-13.1.

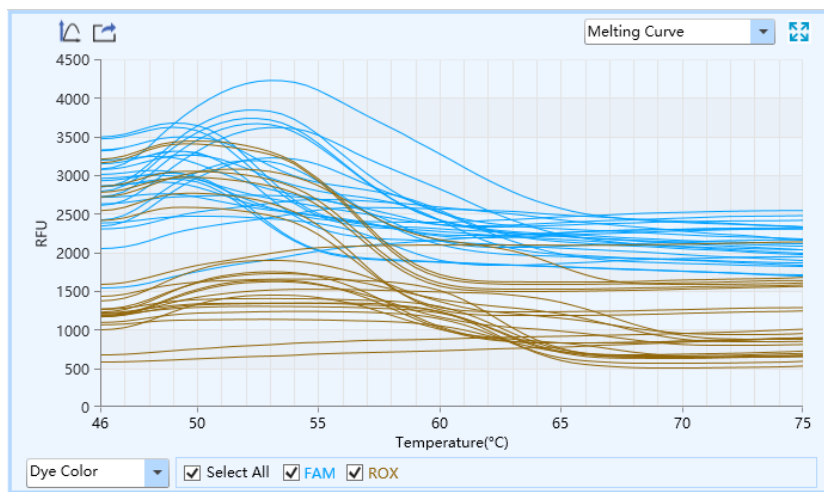



Figure D-13.1. Melting Curve Analysis Interface - Melting Curve Functional Module

► Parameter introduction:

- X axis represents the temperature value;

- Y axis represents the Relative Fluorescence Unit (RFU);

► **Function key introduction:**

- User can select the melting curve display mode from the drop-down list on the bottom left of **Melting Curve** functional module. The melting curve can be displayed according to **Well Color**, **Dye Color**, **Sample Color** and **Gene Color**.
- The introduction of <  **Y-axis Coordinate Adjustment** > and <  **Export** > keys are same with those keys introduced in [D-3.3.4.1 Abs Quant - Amplification Curve](#).

❗ **Reminding:** user can hover mouse over a certain melting curve, the curve will be highlighted and its corresponding channel and well coordinate will be displayed on the right of cursor.

❗ **Reminding:** user can drag and drop the left mouse button to zoom in the local melting curve diagram, or click the right mouse button to zoom out.

II. Melting Peak: display the first negative derivative of the fluorescence intensity ($-dF/dT$) respect to the corresponding temperature, as shown in the figure D-13.2. If there is only a single melting peak, it means that no non-specific PCR products are detected in the experiment.

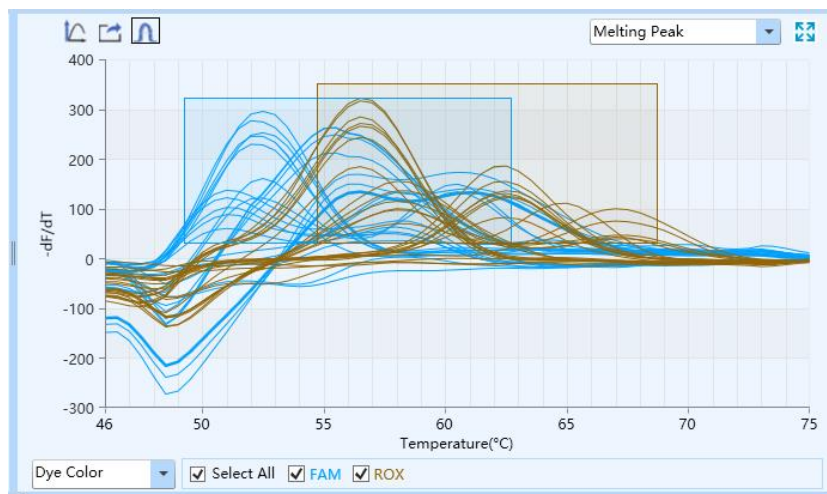

Figure D-13.2. Melting Curve Analysis Interface - Melting Peaks Functional Module





► **Parameter introduction:**

- X axis represents the temperature value;
- Y axis represents the first negative derivative of the fluorescence intensity against the corresponding temperature;

► **Function key introduction:**

- User can select the melting peak display mode from the drop-down list on the bottom left of **Melting Peaks** functional module. The melting curve can be displayed according to **Well**

Color, Dye Color, Sample Color and Gene Color.

- The introduction of <  **Y-axis Coordinate Adjustment** > and <  **Export** > keys are same with those keys introduced in [D-3.3.4.1 Abs Quant - Amplification Curve](#).
- <  **Peak Area** >: user can click <  **Peak Area** > icon to define the melting peak area; each side of the rectangle delimits the temperature and fluorescence range of the peak area.

Melting Curve Analysis Setting

User can click the <  **Analysis Setting** > icon in Tool Bar and the application software will automatically pop up the melting curve analysis setting window, which consists of **Melt Curve** and **Gene and Sample** two tabs. User can set the relevant parameters for melting curve analytical method in the melting curve analysis setting window.



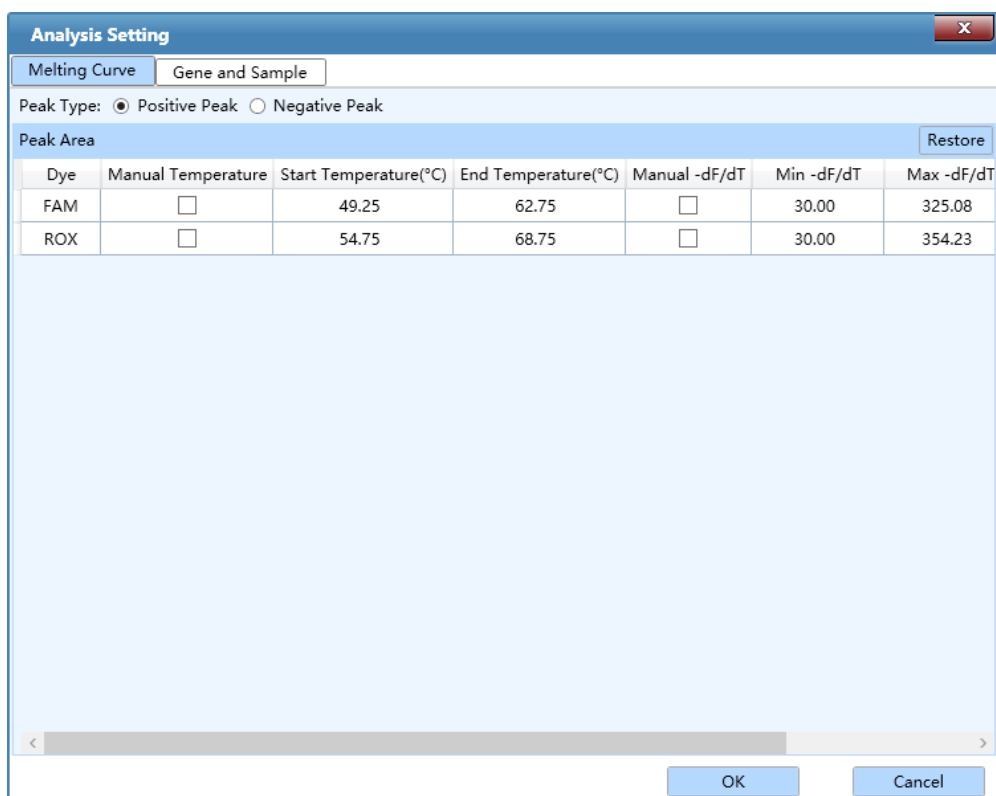

I. Melt Curve tab: display the parameter range of each peak area on the melting curve, as shown in figure D-13.3.



Dye	Manual Temperature	Start Temperature(°C)	End Temperature(°C)	Manual -dF/dT	Min -dF/dT	Max -dF/dT
FAM	<input type="checkbox"/>	49.25	62.75	<input type="checkbox"/>	30.00	325.08
ROX	<input type="checkbox"/>	54.75	68.75	<input type="checkbox"/>	30.00	354.23

Figure D-13.3. Melting Curve Analysis Setting Interface - Melt Curve Tab

- **Peak Type:** user can check the check box of **Positive Peak** or **Negative Peak** to determine the type of melting peak to be analyzed.

- ▶ **Peak Area:** display the melting peak area appearing with temperature rise.
 - User can use  and  keys to set the temperature range of melting peak area in **Min Temperature** and **Max Temperature** columns.
 - User can use  and  keys to set the fluorescence range of melting area in **Min -df/dT** and **Max -df/dT** columns.

II. **Gene and Sample** tab: the introduction of relevant parameters and function keys is same with those introduced in [D-3.3.4.1 Abs Quant - Abs Quant Analysis Setting](#).

3.3.4.4 High Resolution Melting

The melting temperature T_m of dsDNA depends on its base sequence, fragment length and GC content. In theory, any base change can cause difference in melting temperature; however, the difference caused by a base change is tiny, usually less than 1 degree. As the resolution of melting curve is not enough, it is required to read the fluorescence signal several times within one degree of temperature change to accurately detect the difference of melting temperature. Therefore, high resolution melting curve is often used for single nucleotide polymorphism (SNP) analysis, mutation scanning, methylation research and genotyping, etc.

The high resolution melting analysis interface consists of seven functional modules: **Melting Curve**, **Normalized Melting Curve**, **Difference Plot**, **Result Table** and **Sample Setting**, **Normalized Peak Melting** and **Heat Map**. The high resolution melting analysis interface is divided into four areas, which displays four functional modules (**Melting Curve**, **Normalized Melting Curve**, **Difference Plot** and **Result Table**) by default, as shown in figure D-14.

- ⓘ **Reminding:** the parameter descriptions of **Sample Setting**, **Result Table** and **Heat Map** functional modules are same with those introduced in [D-3.3.4.1 Abs Quant](#).

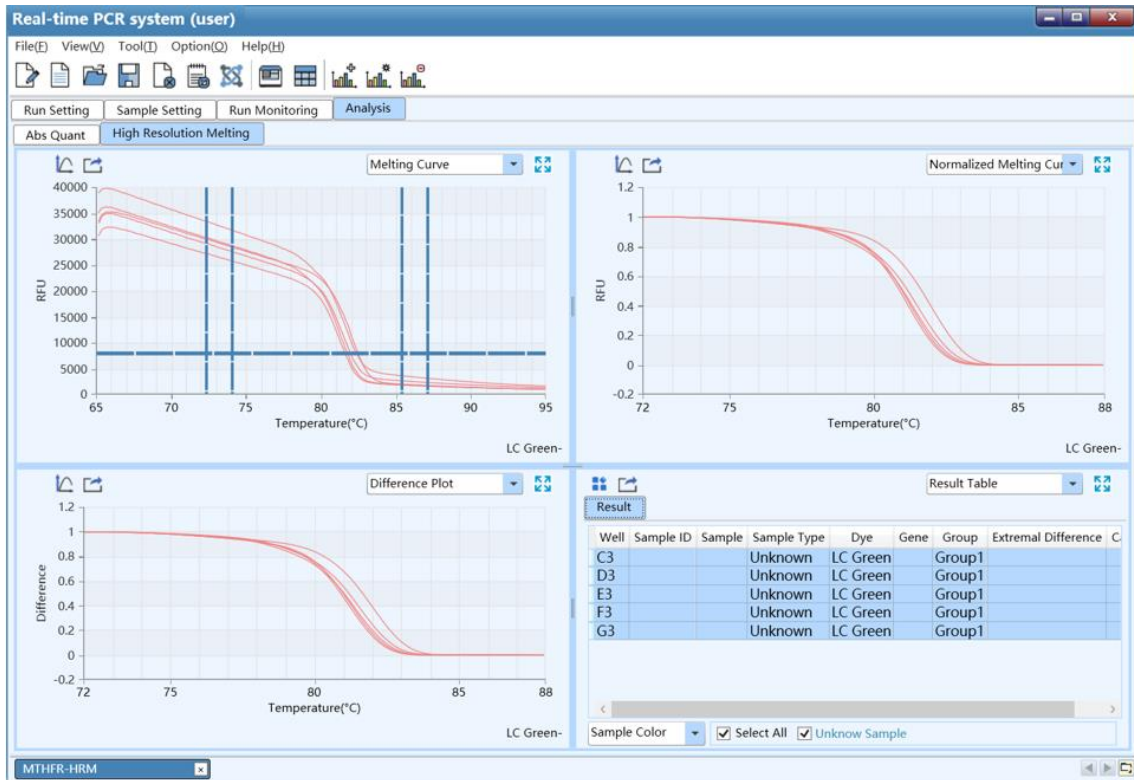

Figure D-14. High Resolution Melting Analysis Interface

Interface Introduction and Parameter Description

I. **Melting Curve**: display the fluorescence intensity against the temperature, as shown in figure D-14.1.

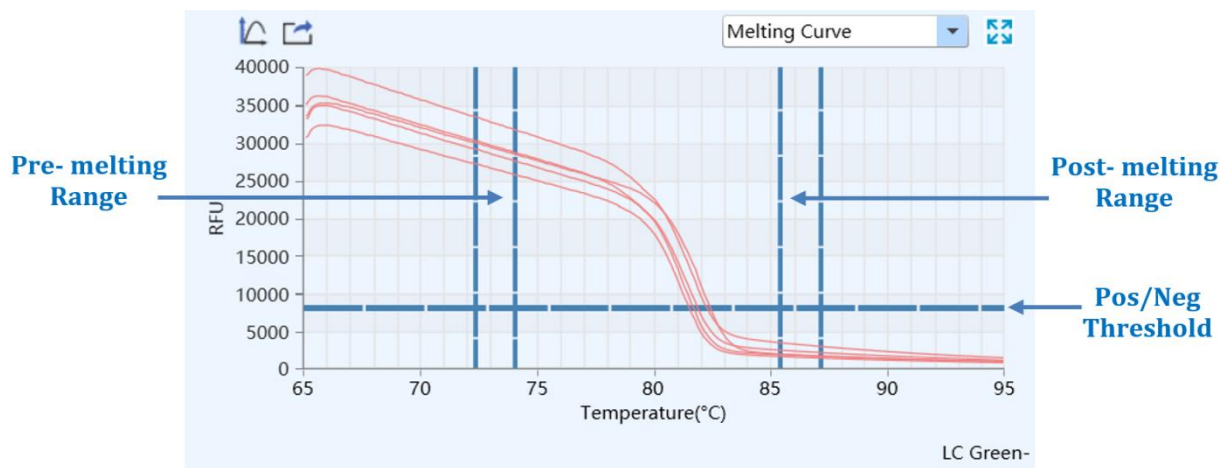



Figure D-14.1. HRM Analysis Interface - Melting Curve Functional Module

► **Parameter introduction:**

- X axis represents the temperature;
- Y axis represents the Relative Fluorescence Unit (RFU);
- By default, the application software will automatically determine normalized area of melting curve. The two vertical sliders on the left are the **Pre-melting Range** threshold lines, which are used to specify the pre-melting temperature range; while two vertical sliders on the right are the **Post-melting Range** threshold lines, which are used to specify the post-melting temperature range; the single line at the bottom is the **Pos/Neg Threshold** line, which is used to determine the positivity or negativity of sample.

► **Function key introduction:**

- The introduction of <  **Y-axis Coordinate Adjustment** > and <  **Export** > keys are same with those keys introduced in [D-3.3.4.1 Abs Quant - Amplification Curve](#).
- User can manually drag the vertical sliders or enter relevant parameter in the high resolution melting analysis setting window to specify the normalized area of melting curve.

ⓘ **Reminding:** if the normalized area is manually changed, the relevant curve shape on **Normalized Melting Peak, Difference Plot, Normalized Melting Curve** functional modules and the group calling result will change accordingly.

II. Normalized Melting Curve: display the normalized melting curve according to the normalization method and fluorescence normalization settings, as shown in figure D-14.2. For more details, please refer to [D-3.3.4.4 High Resolution Melting - High Resolution Melting Analysis Setting](#).

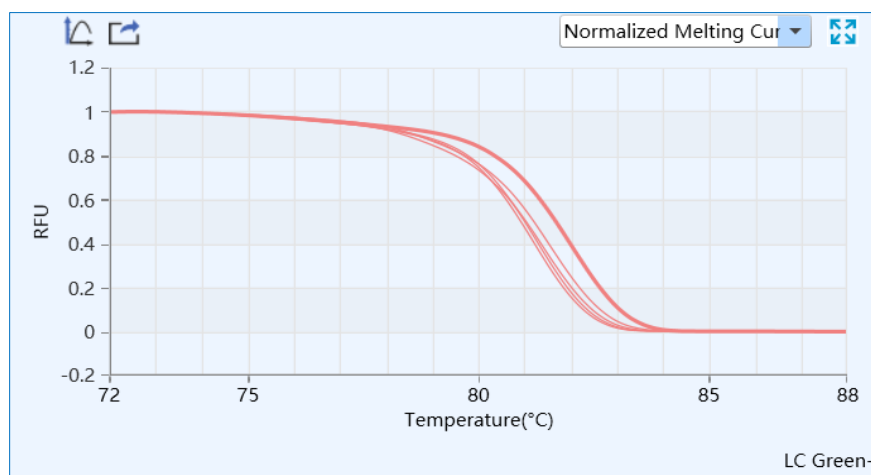

Figure D-14.2. HRM Analysis Interface - Normalized Melting Curve Functional Module

III. Difference Plot: display the curve after subtracting the baseline group curve, after normalization, and optionally, after temperature shift. The appearance of the curve on **Difference Plot** functional module depends on the selected baseline group, as shown in figure D-14.3. For more details, please refer to [D-3.3.4.4 High Resolution Melting - High Resolution Melting Analysis Setting](#).

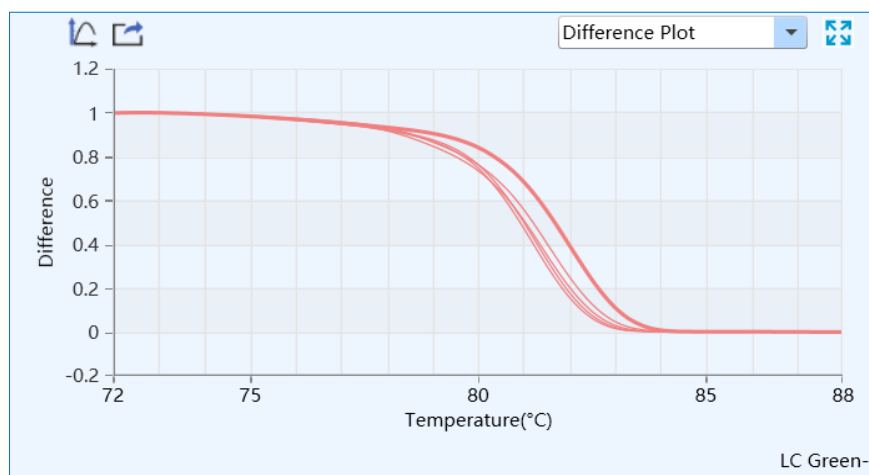

Figure D-14.3. HRM Analysis Interface - Difference Plot Functional Module

IV. Normalized Melting Peak: display the first negative derivative of the normalized melting curve, as shown in figure D-14.4. The melting temperature range of each sample appears as a peak after normalization, and optionally, temperature shift.

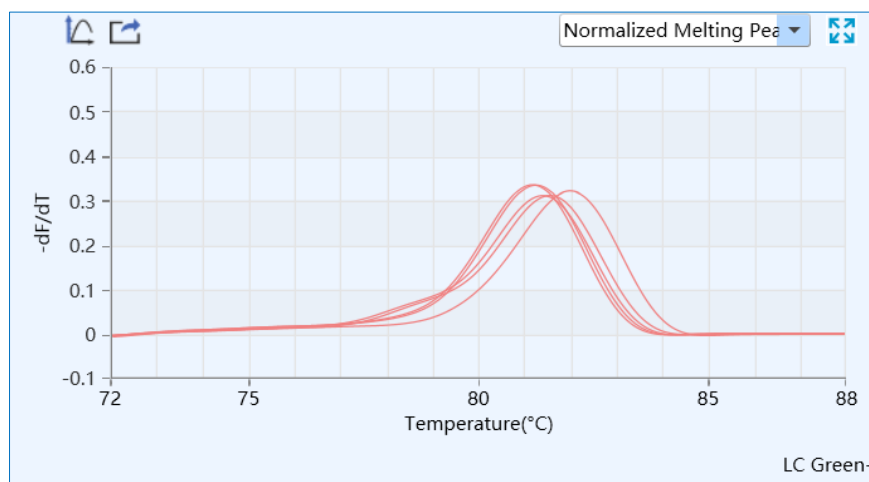



Figure D-14.4. HRM Analysis Interface - Normalized Peak Melting Functional Module

High Resolution Melting Analysis Setting

User can click the  **Analysis Setting** > icon in Tool Bar and the application software will automatically pop up the high resolution melting analysis setting window, which consists of **Dye and Gene, Sample** and **High Resolution Melting** three tabs. User can set the relevant parameters for current analytical method in the high resolution melting analysis setting window.

- I. **High Resolution Melting** tab: user can set the **Normalization Method, Fluorescence Normalization, Sensitivity, Reference** and **Other** parameters for the current analytical method as shown in figure D-15.

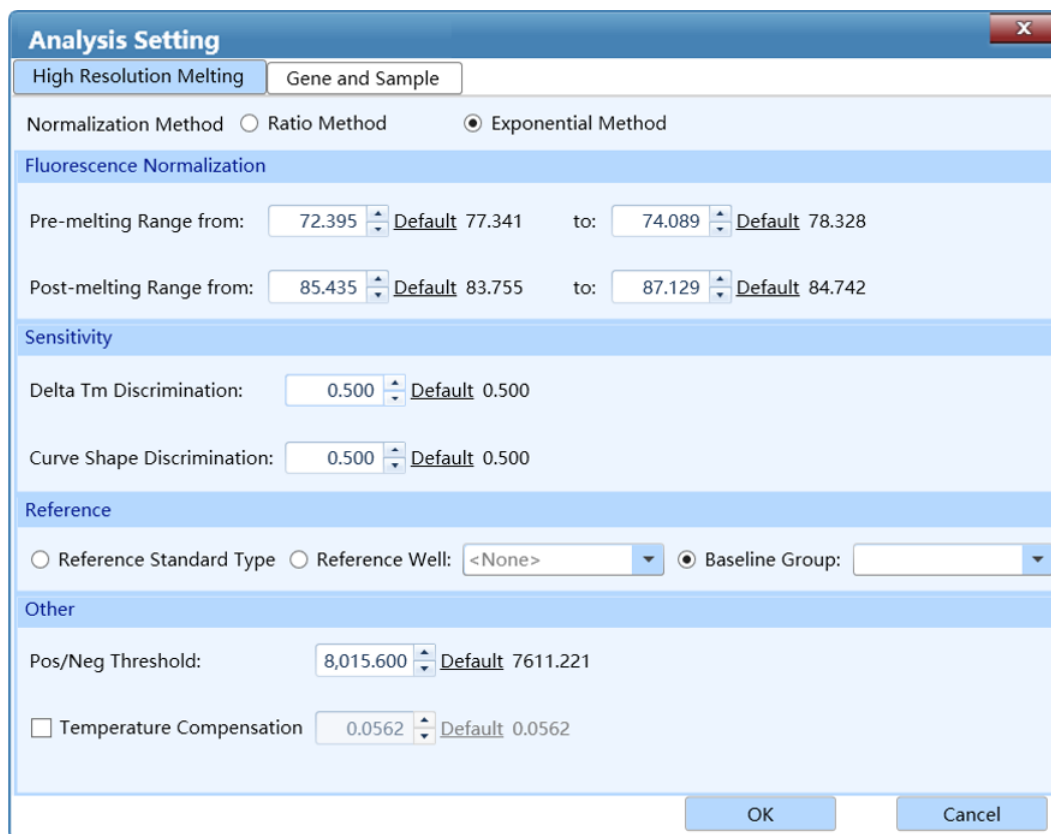





Figure D- 15. High Resolution Melting Analysis Setting Interface - High Resolution Melting Tab

- ▶ **Normalization Method:** the application software provides two normalization methods: **Ratio Method** and **Exponential Method**. The **Ratio Method** option is selected by default.
- ▶ **Fluorescence Normalization:** used to set the temperature range for the fluorescence normalization of the melting curve.
 - a. **Pre-Melt Range:** user can use  and  keys to set the pre-melting temperature range of the normalization area of the melting curve.
 - b. **Post-Melt Range:** user can use  and  keys to set the post-melting temperature range

of the normalization area of the melting curve.

- ▶ **Sensitivity:** to set the discrimination sensitivity of melting curve.







Reminding: by default, the application software will automatically set the corresponding parameters for the fluorescence normalization of melting curve; user can also drag the relevant threshold lines (vertical sliders) on the **Melting Curve** functional module to determine the normalized area of melting curve.

- a. **Delta T_m Discrimination:** the default Delta T_m discrimination sensitivity provided by the amplification software is 0.5; reduce this value, the application software will group the melting curve at a higher temperature resolution.
- b. **Curve Shape Discrimination:** the default curve shape discrimination sensitivity provided by the amplification software of is 0.5; reduce this value, the application software will group the melting curve at a higher shape resolution.

- ▶ **Reference:** to set the **Reference Standard Type** for high resolution melting analysis.

- a. **Reference Well:** user can set the standard sample of specific well as the reference for the **Difference Plot** functional analysis of HRM experiment.
- b. **Baseline Group:** user can set the baseline gene group as the reference for the **Difference Plot** functional analysis of HRM experiment.

- ▶ **Other:**

- a. **Pos/Neg Threshold:** user can use  and  keys to set the threshold value for the application software to determine the positivity or negativity of samples
- b. **Temperature Compensation:** user can check **Temperature Compensation** check box and the application software will automatically calculate the temperature compensation value between sample block wells. User can use  and  keys to change the temperature compensation value.

II. Gene and Sample tab: the introduction of relevant parameters and function keys is same with those introduced in [D-3.3.4.1 Abs Quant - Abs Quant Analysis Setting](#).

3.3.4.5 Genotyping

The Genotyping analysis adopts two sequence-specific probes labeled with different dyes to identify the wild type and mutation alleles, respectively. After running the experiment program, the application software will automatically detect the end point fluorescence and distinguish

different genotypes based on the distribution of two dyes on the scatter plot. The Genotyping analysis interface consists of seven functional modules: **Amplification Curve**, **Scatter Plot**, **Sample Setting**, **Result Table**, **Raw Curve**, **Raw Fluorescence** and **Heat Map**. The Genotyping analysis interface is divided into four areas, the application software displays four functional modules (**Amplification Curve**, **Scatter Plot**, **Sample Setting**, **Result Table**) by default, as shown in figure D-16.

! **Reminding:** the parameter descriptions of **Amplification Curve**, **Sample Setting**, **Raw Curve**, **Raw Fluorescence** and **Heat Map** functional modules are same with those introduced in **D-3.3.4.1 Abs Quant**.

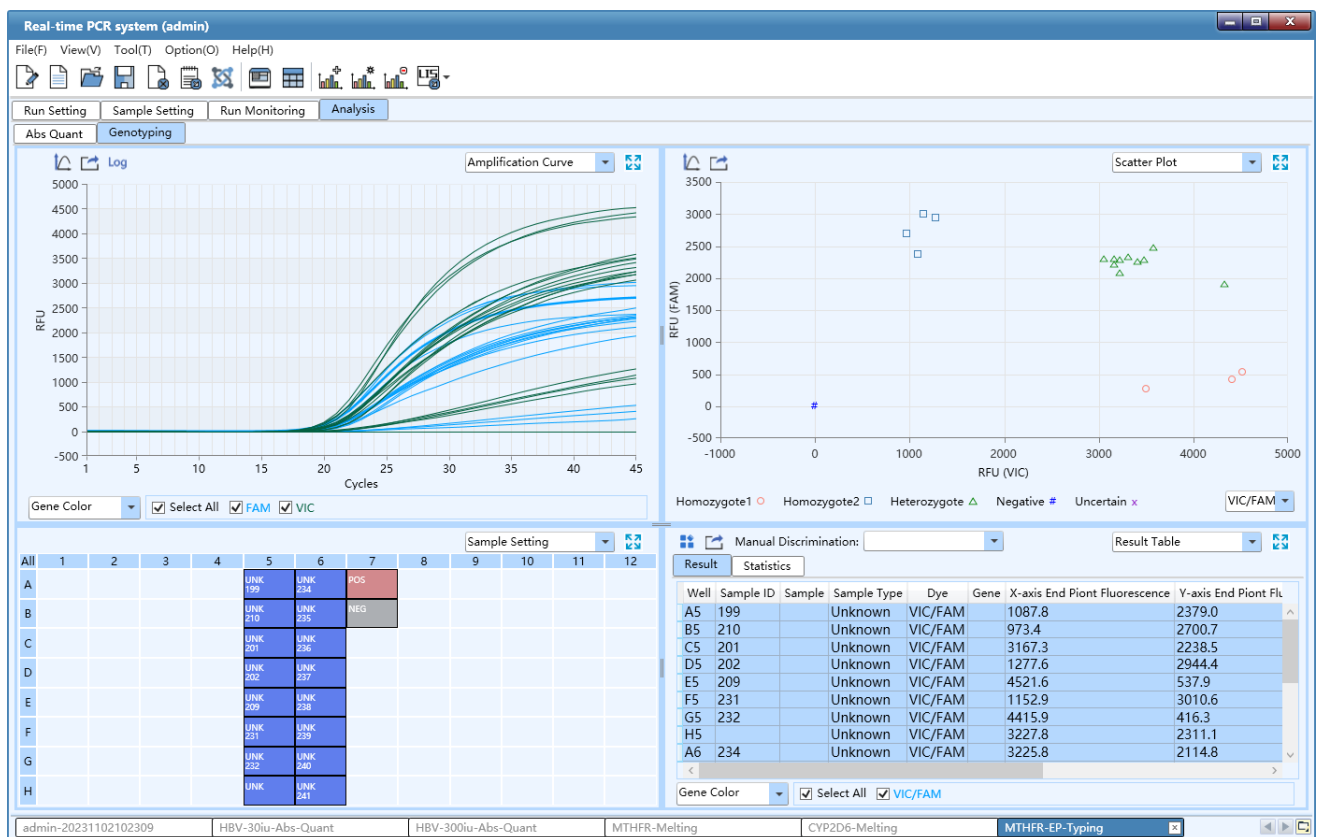

Figure D-16. Genotyping Analysis Interface

Interface Introduction and Parameter Description

I. Scatter Plot: display the end point fluorescence distribution of two dyes, as shown in figure D-16.1.

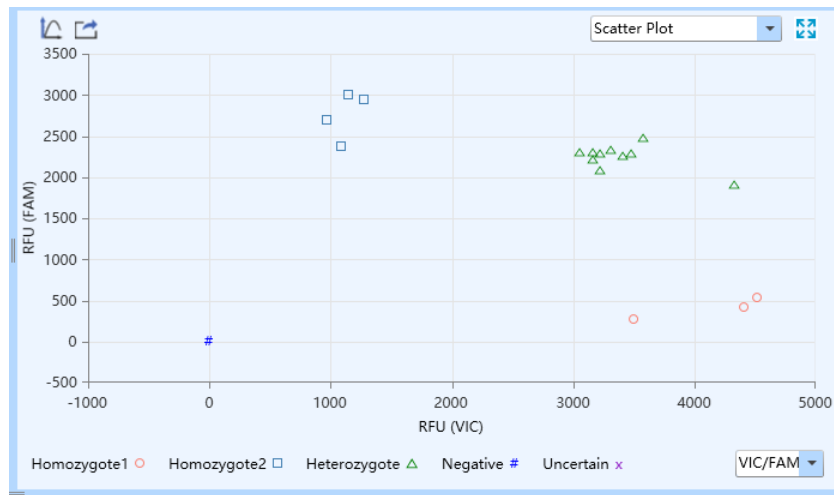



Figure D-16.1. Genotyping Analysis Interface - Scatter Plot Functional Module

► **Parameter introduction:**

- X axis and Y axis represent the Relative Fluorescence Unit (RFU) of different dyes respectively;
- Each point represents a sample; different icons represent different genotypes or interpretation results.

► **Function key introduction:**

- The introduction of  *Y-axis Coordinate Adjustment* > and  *Export* > keys are same with those keys introduced in *D-3.3.4.1 Abs Quant - Amplification Curve*.

II. Result Table: display the sample details of and result data of the current experiment, as shown in figure D-16.2.

Well	Sample ID	Sample	Sample Type	Dye	Gene	X-axis End Point Fluorescence	Y-axis End Point Flu
A5	199		Unknown	VIC/FAM		1087.8	2379.0
B5	210		Unknown	VIC/FAM		973.4	2700.7
C5	201		Unknown	VIC/FAM		3167.3	2238.5
D5	202		Unknown	VIC/FAM		1277.6	2944.4
E5	209		Unknown	VIC/FAM		4521.6	537.9
F5	231		Unknown	VIC/FAM		1152.9	3010.6
G5	232		Unknown	VIC/FAM		4415.9	416.3
H5			Unknown	VIC/FAM		3227.8	2311.1
A6	234		Unknown	VIC/FAM		3225.8	2114.8

Figure D-16.2. Genotyping Analysis Interface - Result Table Functional Module

- User can double click the title of each column to sort all sample results according to the

content in this column.

- User can click the title of each column and drag the column to the left or right to adjust the sequence of sample results.
- By default, the application software will automatically discriminate the different genotypes. But user can also select any sample in the **Result Table** list and set the genotype for the selected sample from the **Manual Discrimination** drop-down list.

Genotyping Analysis Setting

User can click the  **Analysis Setting** > icon in the Tool Bar and the application software will automatically pop up the genotyping analysis setting window, which consists of **Genotyping**, **Gene** and **Sample** two tabs. User could set the relevant parameters for the current analytical method in the genotyping analysis setting window.

- Genotyping** tab: user can set **Analysis Mode** and **Gene Group Parameter** in **Genotyping** tab, as shown in figure D-17.

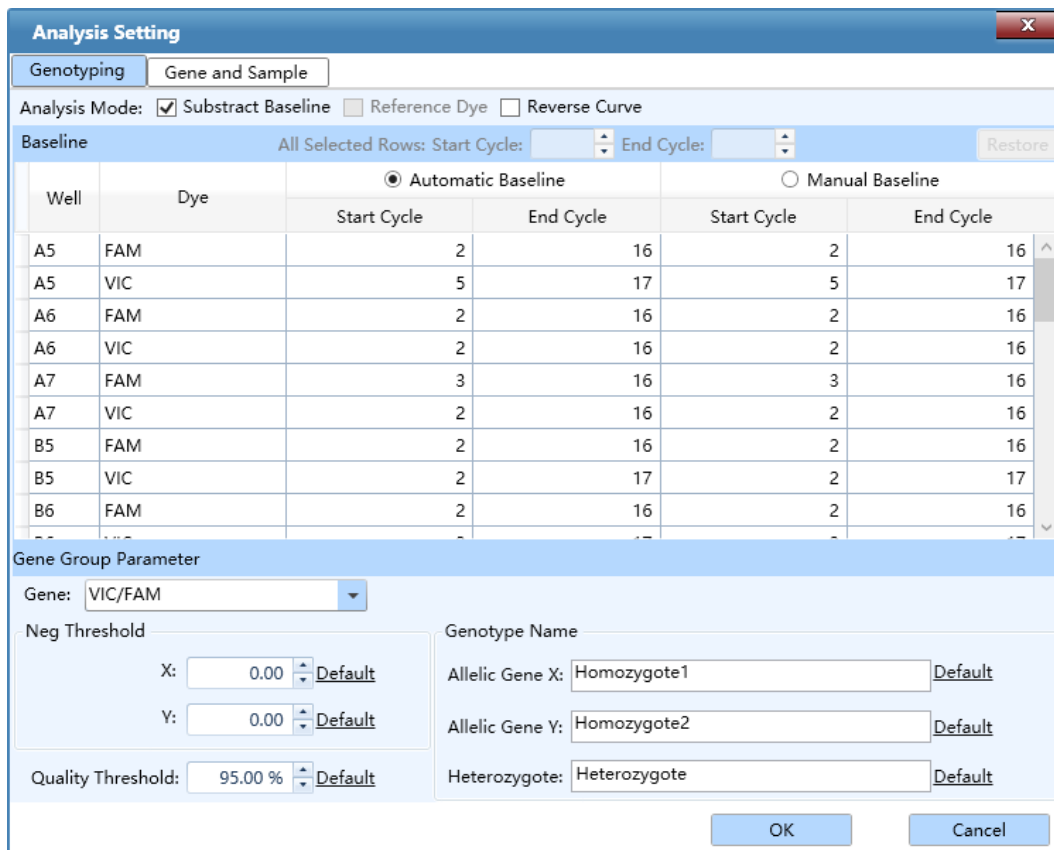





Figure D-17. Genotyping Analysis Setting Interface - Genotyping Tab

- ▶ **Analysis Mode:** same with the introduction of [D-3.3.4.1 Abs Quant - Abs Quant Analysis Setting - Amplification Curve tab](#).
- ▶ **Gene Group Parameter:**
 - a. **Gene:** display the detective dyes of different genotypes;
 - b. **Neg Threshold:** user can use  and  keys to set the corresponding negative threshold for the X axis and Y axis of scatter plot.
 - c. **Quality Threshold:** user can use  and  keys to set the quality threshold of application software algorithm. Increase the quality threshold value can improve the credibility of grouping result.
 - d. **Genotype Name:** user can change the grouping name of allelic gene and heterozygote gene.
- II. **Gene and Sample tab:** the introduction of relevant parameters and function keys is same with those introduced in [D-3.3.4.1 Abs Quant - Abs Quant Analysis Setting](#).

3.3.4.6 End Point Fluorescence

The end point fluorescence analysis displays the final detection result based on the fluorescence intensities measured at the end point of amplification plateau phase.

The end point fluorescence analysis interface consists of seven functional modules: **Amplification Curve**, **End Point Fluorescence Scatter Plot**, **Sample Setting**, **Result Table**, **Raw Curve**, **Raw Fluorescence** and **Heat Map**. The end point fluorescence analysis interface is divided into four areas, the application software displays four functional modules (**Amplification Curve**, **End Point Fluorescence Scatter Plot**, **Sample Setting**, **Result Table**) by default, as shown in figure D-18.

- ⓘ **Reminding:** the parameter descriptions of **Amplification Curve**, **Sample Setting**, **Result Table**, **Raw Curve**, **Raw Fluorescence** and **Heat Map** functional modules are same with those introduced in [D-3.3.4.1 Abs Quant](#).

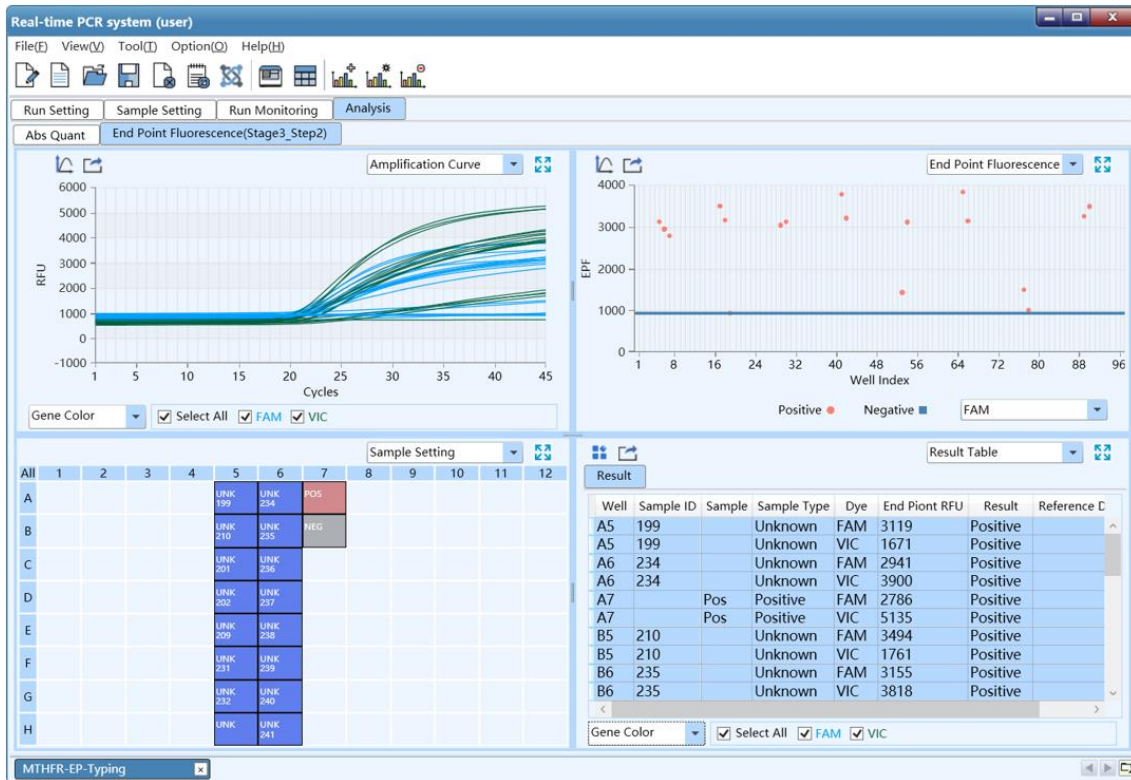

Figure D-18. End Point Fluorescence Analysis Interface

Interface Introduction and Parameter Description

I. End Point Fluorescence Scatter Plot: display the scatter plot of fluorescence intensities measured at end the point of amplification plateau phase, as shown in figure D-18.1.

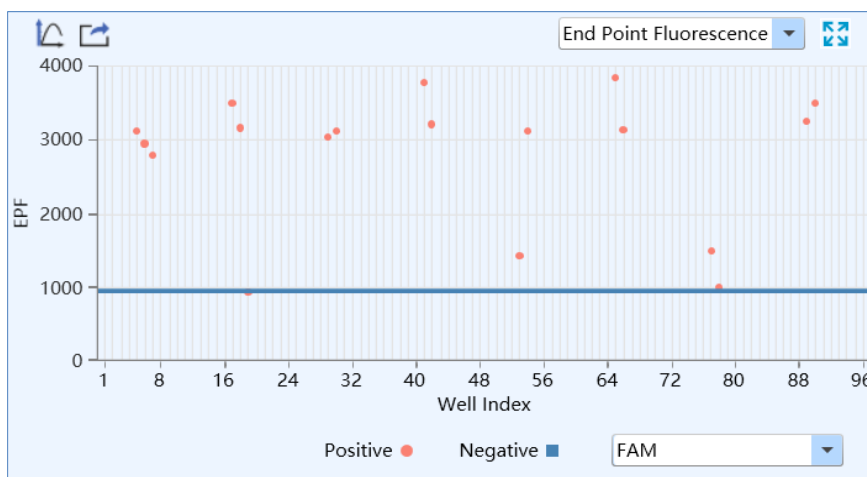



Figure D-18.1. End Point Fluorescence Analysis Interface - End Point Fluorescence Scatter Plot

► Parameter introduction:

- X axis represents the sample well index of the current experiment samples;
- Y axis represents the End Point Fluorescence (EPF) intensity;
- Each point represents a sample; different icons represent the negative or positive interpretation results.

► **Function key introduction:**

- The introduction of <  **Y-axis Coordinate Adjustment** > and <  **Export** > keys are same with those keys introduced in [D-3.3.4.1 Abs Quant - Amplification Curve](#).

End Point Fluorescence Analysis Setting

User can click the <  **Analysis Setting** > icon in Tool Bar and the application software will automatically pop up the end point fluorescence analysis setting window, which consists of **End Point Fluorescence** and **Gene and Sample** two tabs. User can set the relevant parameters for the current analytical method in the end point fluorescence analysis setting window.

I. **End Point Fluorescence** tab: as shown in figure D-19.

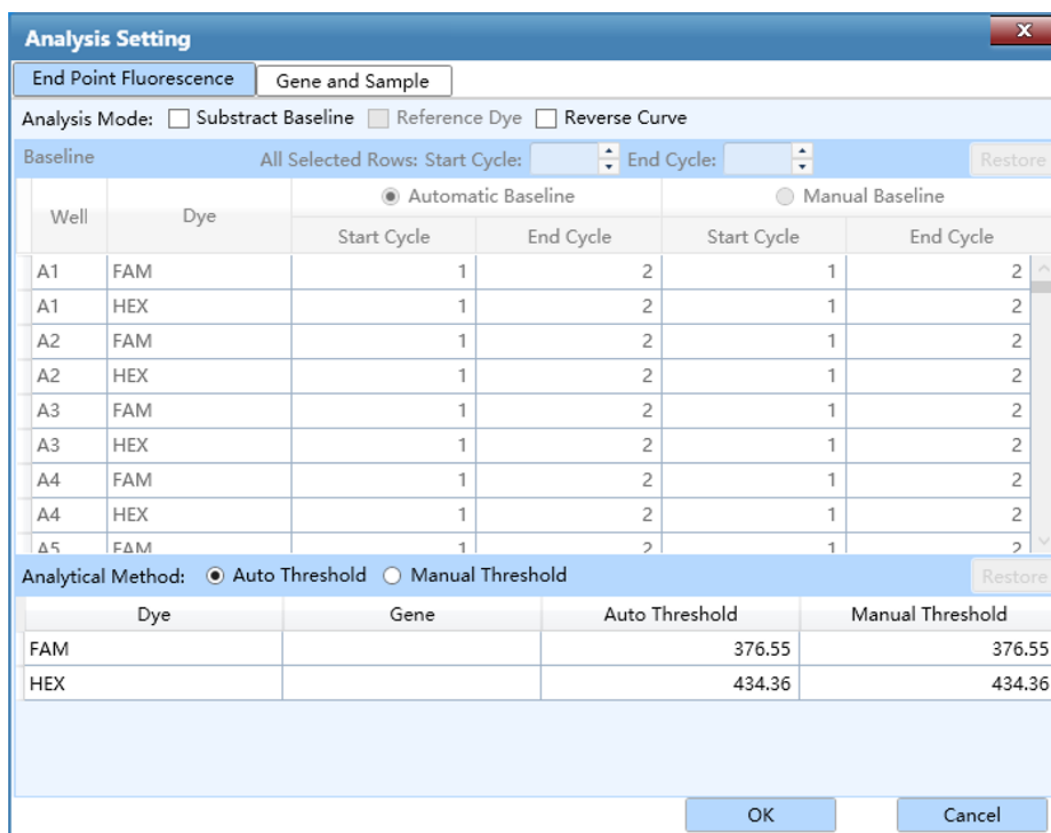

Analysis Setting

End Point Fluorescence | Gene and Sample

Analysis Mode: Subtract Baseline Reference Dye Reverse Curve

Baseline: All Selected Rows: Start Cycle: [] End Cycle: [] Restore

Well	Dye	Automatic Baseline		Manual Baseline	
		Start Cycle	End Cycle	Start Cycle	End Cycle
A1	FAM	1	2	1	2
A1	HEX	1	2	1	2
A2	FAM	1	2	1	2
A2	HEX	1	2	1	2
A3	FAM	1	2	1	2
A3	HEX	1	2	1	2
A4	FAM	1	2	1	2
A4	HEX	1	2	1	2
A5	FAM	1	2	1	2

Analytical Method: Auto Threshold Manual Threshold Restore

Dye	Gene	Auto Threshold	Manual Threshold
FAM		376.55	376.55
HEX		434.36	434.36

OK Cancel

Figure D-19. End Point Fluorescence Analysis Setting Interface - End Point Fluorescence Tab

- **Analysis Mode:** same with the introduction of *D-3.3.4.5 Genotyping - Genotyping Analysis Setting - Genotyping tab.*
 - **Analytical Method:** same with the introduction of *D-3.3.4.5 Genotyping - Genotyping Analysis Setting - Genotyping tab.*
- II. **Gene and Sample** tab: the introduction of relevant parameters and function keys is same with those introduced in *D-3.3.4.1 Abs Quant - Abs Quant Analysis Setting.*

E. Instrument Software Operation

The Gentier instrument can run independently from the control computer. User can use the touch screen or external mouse to operate the instrument system software, so as to realize the experiment program setting and other relevant operations.

1. Boot Screen & Main Menu Interface

Switch on the power switch, the Gentier instrument system will automatically conduct self-inspection, the touch screen will light up and display instrument software boot screen. After self-inspection, the instrument software will enter the main interface, which is consisted of status bar, operation area, operation log and main function keys, as shown in figure E-1.

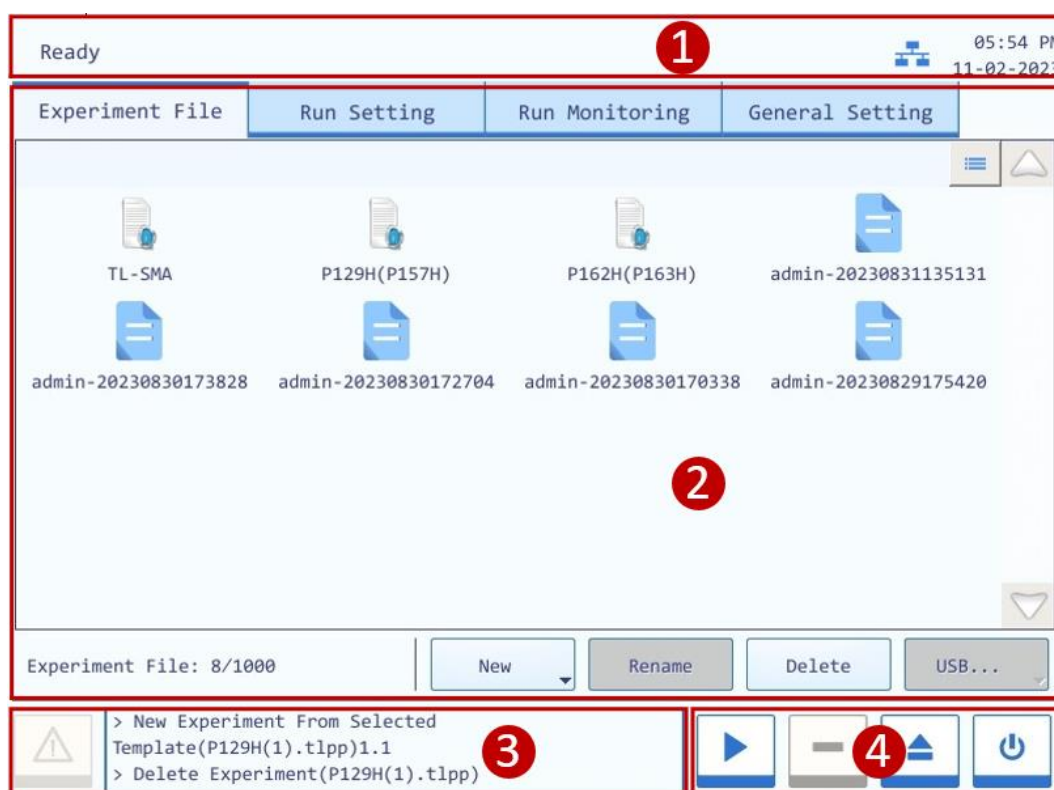

















Figure E-1. Instrument Software Main Interface

Interface Introduction & Parameter Descriptions

1. **Status Bar:** display the system status, current file name, instrument status and system time.
 - ▶ **System Status:** display the current instrument system status.
 - **Initializing:** the instrument system is in the process of initialization;

- **Ready:** the instrument system initialization is completed, ready for running;
 - **Running:** the experiment is running;
 - **Pause:** the current running experiment is paused;
 - **Error:** instrument hardware or software error, cannot execute any operation.
- ▶ **File Name:** display the current experiment file name and its file path.
- ▶ **Instrument Status:** display the current instrument status.
- <  **Not Connected** >: the instrument is not connected to the network;
 - <  **Connected** >: the instrument is connected to the network;
 - <  **USB** >: the instrument is connected with USB device;
 - <  **Hot Lid Used**>: the hot lid heating function is enabled;
 - <  **Hot Lid Unused** >: the hot lid heating function is not enabled;
 - <  **Error** >: the instrument hardware or software error has occurred, cannot execute any operation.
- ▶ **System Time:** display the current system date and time.
2. **Operation Area:** includes **Experiment File, Run Setting, Run Monitoring, General Setting** four tabs, for more operation details, please refer to [E-2 Instrument Software Operation Area](#).
3. **Operation Log:** display the operation record of the current Gentier instrument.
- ⓘ **Reminding:** under normal system status, the caution symbol within the operation log window is displayed as grey icon , however this icon will turn yellow or red when a certain system error occurs, and the corresponding error information will be shown in the operation log window. The yellow icon  indicates that the Gentier instrument can still execute the current operation while the Red icon  indicates that the Gentier instrument cannot execute the current operation;
4. **Main Function Key:**
- ▶ <  **Run Experiment** >: start running the current experiment. This function key is activated when the instrument system is under **Ready** or **Pause** status.
- ⓘ **Reminding:** when the instrument system is under **Running** status, the <  **Run Experiment** > function key will be converted to <  **Pause Experiment** > function key, user can press this function key to pause the current running experiment.

- ▶ <  **Stop Experiment** >: stop the current running experiment. This function key is activated when the instrument system is under **Running** status.
- ▶ <  **Open / Close** >: open or close the loading platform.
 - ⓘ **Reminding**: user can also gently push the loading platform to close it.
- ▶ <  **Shutdown / Restart** >: shutdown or restart the instrument. This function key is inactivated when the instrument system is under **Running** status.
 - ⓘ **Reminding**: when the user turns off the instrument, please wait for the shutdown progress bar on the instrument interface to complete, and then turn off the power switch of the instrument.

2. Instrument Software Operation Area

The operation area of the system software includes **Experiment File**, **Run Setting**, **Run Monitoring**, **General Setting** four tabs. User could perform relevant operations and set the corresponding contents according to the specific experimental requirements.

- ▶ **Experiment File**: display experiment files and provide the relevant experiment file operations;
- ▶ **Run Setting**: provide the experiment temperature and fluorescence setting operations;
- ▶ **Run Monitoring**: provide the real-time running state of the experiment and display the real-time fluorescence and temperature data of the current running experiment.
- ▶ **General Setting**: provide general setting operations of the current instrument system.

2.1 Experiment File

The main interface of instrument software displays the experiment file tab by default. This tab is consisted of three parts: experiment file display area, experiment file information window and experiment file action bar, as shown in figure E-2.

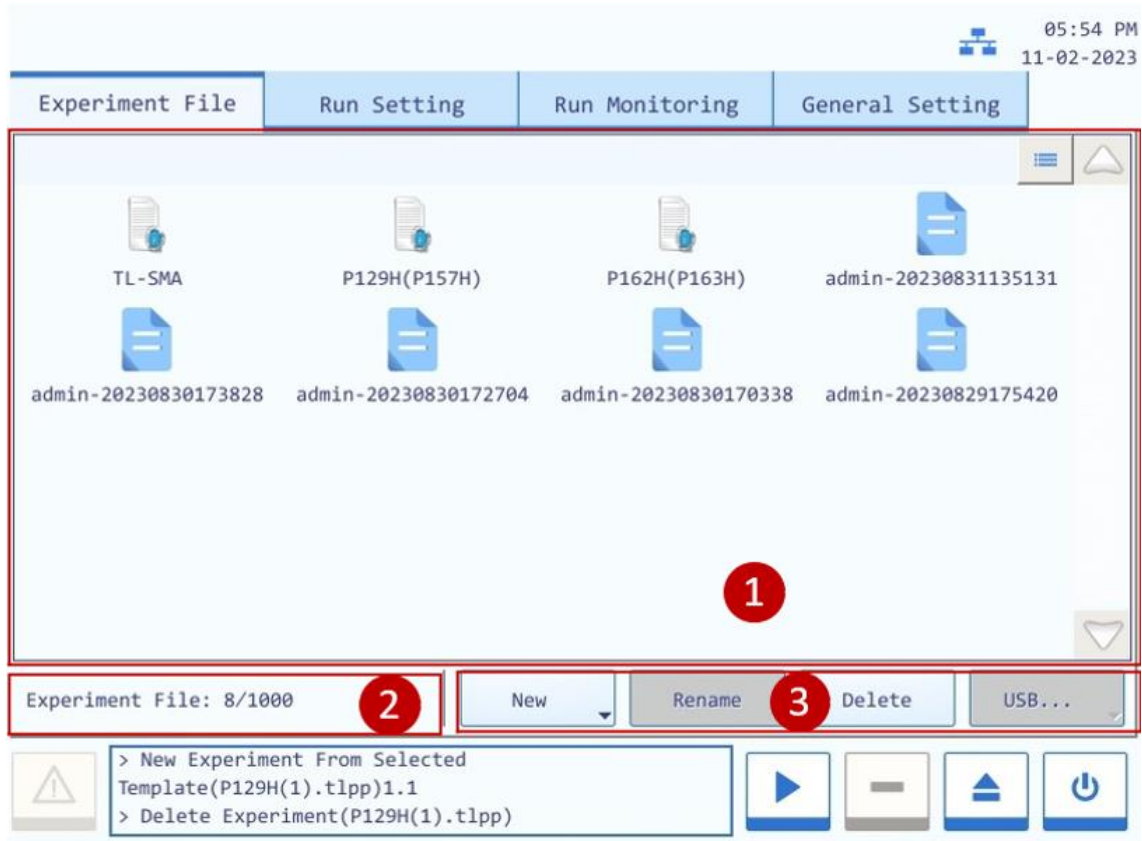

Figure E-2. Instrument Software – Experiment File Interface

Interface Introduction & Parameter Descriptions

1. **Experiment File Displaying Area:** display the pre-existed experiment templates and experiment files or file folders within the instrument system, as shown in figure E-2.1.

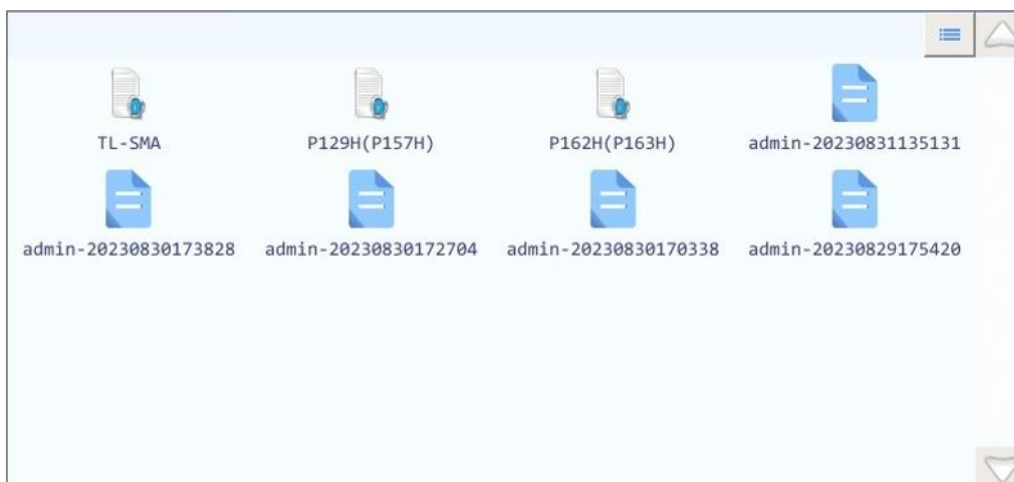





Figure E-2.1. Experiment File Tab - Experiment File Display Area

- ▶ User can press the icon of a certain experiment file or file folder in the experiment file display area to open it.
 - ▶ User can slide the slider or press  and  icons to view all the experiment files or file folders in the experiment file display area.
 - ▶ User can press the  icon on the top left corner of the experiment file display area and it will turn into  icon, and the display mode of the experiment file displaying area will change from icons to file details list.
2. **Experiment File Information Window:** display the pre-existed experiment quantity within the instrument system, as shown in figure E-2.2.



Experiment File: 2/1000

Figure E-2.2. Experiment File Tab - Experiment File Information Window

3. **Experimental file action bar:** consists of < **New** >, < **Rename** >, < **Delete** > and < **USB...** > four keys, as shown in figure E-2.3.



Figure E-2.3. Experiment File Tab - Experimental File Action Bar

- ▶ < **New** >: create a new experiment file or file folder, this key is inactivated when the instrument system is under **Running** status. Press the  icon, there are two options in the drop-down list.
 - **New Experiment:** create a new experiment file.
 - **New Experiment from Project:** user could create a new experiment based on the project.

When user select a template and press < **New** >, a new experiment from selected template will be created.

- ⚠ **Reminding:** the system will pop up a keyboard for user to name the new experiment file or file folder, as shown in figure E-2.4. User can press < **Close** > to exit the keyboard.

- ❗ **Reminding:** the instrument software will name the new experiment file or file folder with creation date and time by default.



Figure E-2.4. Experiment File Tab - Keyboard

- ▶ **< Rename >**: rename the selected experiment file or file folder, this key is inactivated when the instrument system is under **Running** status.
- ▶ **< Delete >**: delete the selected experiment file or file folder, this key is inactivated when the instrument system is under **Running** status.
- ▶ **< USB... >**: execute file transmission between the instrument and USB device. Press the  icon, there are two options in the drop-down list.
 - **Export Experiment**: export the selected experiment file or file folder from the instrument system to the USB device.
 - **Import Experiment**: import the selected experiment file or file folder from the USB device to the instrument system.
- ❗ **Reminding:** If there are more than one USB devices connected to the current instrument, after selecting the **Export Experiment** or the **Import Experiment** option, the instrument software will automatically pop up the USB device list for user to choose the proper USB device.

2.2 Run Setting

The run setting tab consists of **Temperature Setting** and **Fluorescence Setting** two sub-tabs, as shown in figure E-3.

- ❗ **Reminding:** the system will automatically enter the run setting interface after new experiment file creation;
- ❗ **Reminding:** user could also select an experiment file, press **Run Setting** tab to enter the run setting interface to view or edit the experimental settings.

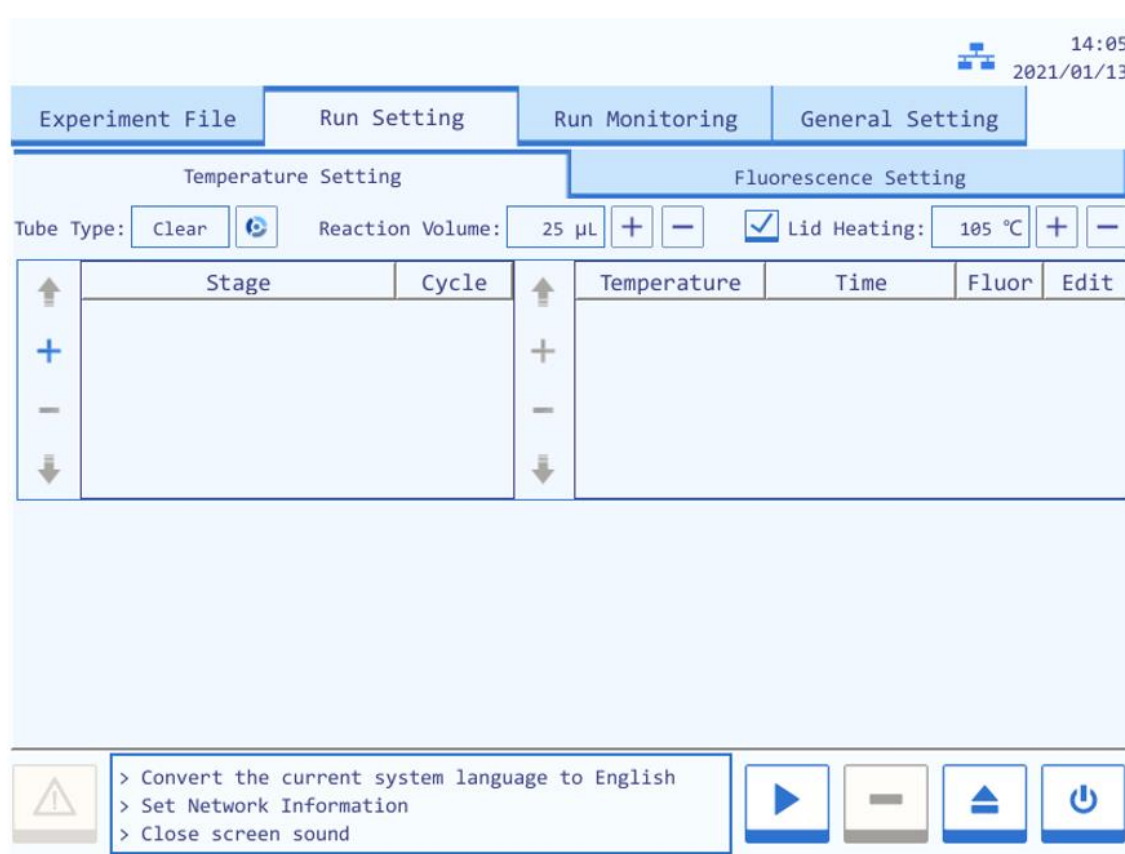





Figure E-3. Run Setting Interface - Temperature Setting Sub-tab

2.2.1 Temperature Setting

The **Temperature Setting** sub-tab is selected on the run setting interface by default, as shown in figure E-3. User can edit the relevant experiment settings and temperature program in the **Temperature Setting** sub-tab.

Interface Introduction & Parameter Descriptions

1. **Tube Type:** the instrument software provides three tube type operations for user, including **Clear**, **White** and **Frosted**. User can press  icon to select.
2. **Reaction Volume:** user can press  or  icons to set the reaction volume.

Reminding: the reaction volume setting range is 0 μ L~100 μ L.

3. **Hot Lid:** user could press the check box of **Hot Lid** to decide whether to utilize the hot lid heating function, and press + or - icons to edit the hot lid temperature.

Reminding: the hot lid temperature setting range is 40 $^{\circ}$ C ~110 $^{\circ}$ C.

4. **Stage Setting Box:**

- **Stage:** display the stage type of the temperature program.
- **Cycle:** display the cycle number of the current stage.
- < ^ **Up** >: move up the selected stage.
- < + **Add** >: add a new stage.
- < - **Delete** >: delete the selected stage.
- < v **Down** >: move down the selected stage.

5. **Step Setting Box:**

- **Temperature:** display the target temperature of the current step.
- **Time:** display the temperature holding time of the current step.
- **Fluor:** display whether to read the fluorescence at the current temperature step;
- **Edit:** press icon in **Edit** column to edit the corresponding step.
- < ^ **Up** >: move up the selected step.
- < + **Add** >: add a new step.
- < - **Delete** >: delete the selected step.
- < v **Down** >: move down the selected step.

6. **Temperature program area:** after stage or step setting, the temperature program area will display the current temperature program, as shown in figure E-3.1. The parameter descriptions are same with those introduced in *D-3.3.1 Run Setting - Introduction to Temperature Program Area*.

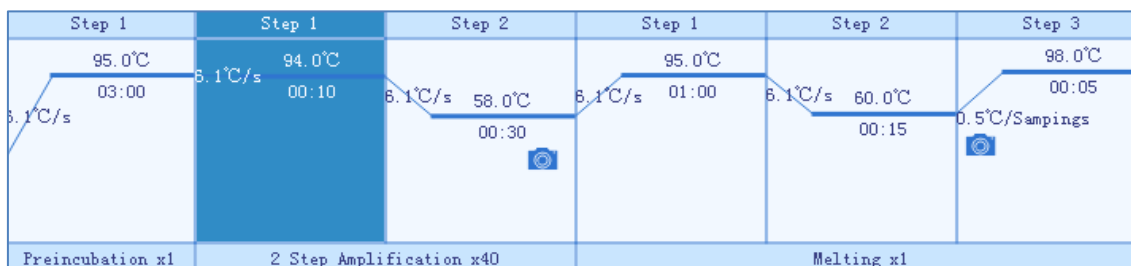



Figure E-3.1. Temperature Setting Sub-tab - Example Temperature Program

Temperature Program Setting Operation

Step 1: Add stage

User can press <  **Add** > in the stage setting box and the instrument software will automatically pop up a stage type selection window, as shown in figure E-3.2.

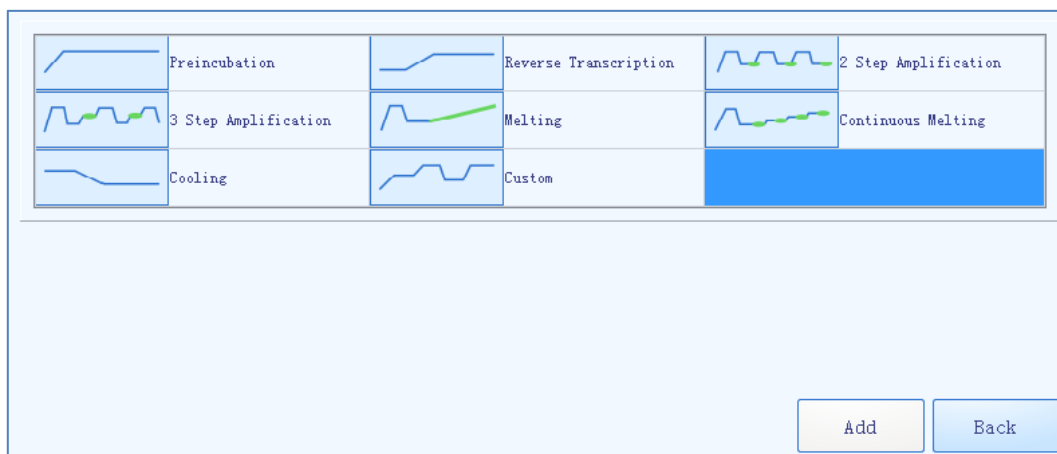



Figure E-3.2. Temperature Setting Sub-tab - Stage Type Selection Window

- ▶ Seven predefined stage types are provided by the instrument software for user: **Preincubation, Reverse Transcription, 2 Step Amplification, 3 Step Amplification, Melting, Continuous Melting** and **Cooling**. User can also press **Custom Stage** to define the stage setting according to specific experiment requirements.
 - ▶ User can press < **Add** > to add the selected stage to stage setting box.
 - ▶ User can press < **Back** > to return back to the run setting interface.
-  **Reminding:** at least one stage should be included in the temperature program.

Step 2: Edit stage

- ▶ The added stage will be automatically displayed in the stage setting box and user can select any stage to delete or change its sequence.
- ▶ User can select a certain stage and press its cycle number in the corresponding **Cycle** column, the cycle edit box will pop up as shown in figure E-3.3.

Figure E-3.3. Cycle Edit Box

- ▶ User could set the cycle number in the cycle edit box, press < **OK** > to confirm the cycle setting or press < **Cancel** > to cancel the setting.

⚠ Reminding: the cycle setting range is 1~99.

Step 3: Add/delete a stage

- ▶ Select a stage in the stage setting box and the step setting box on the right will display the corresponding steps of the selected stage;
- ▶ User can add a new step or select a step to delete or change its order;

⚠ Reminding: at least one step should be included in one stage.

Step 4: Set fluorescence reading step

- ▶ In the step setting box, user can press the **Fluor** column of a certain step to set whether to read its fluorescence, the  icon will be displayed in the corresponding **Fluor** column of the fluorescence reading step.

⚠ Reminding: user can set only one fluorescence reading step in one stage.

Step 5: Edit step

User can select a certain step in the step setting box, and press the  icon in the corresponding **Edit** column, the instrument software will automatically pop up the step edit window, as shown in figure E-3.4.

- Four **Step Mode** options are provided by the instrument software: **Standard**, **Touchdown**, **Gradient** and **Long**. User can select a certain step mode option by pressing the  icon in front of it, and the icon will turn blue.

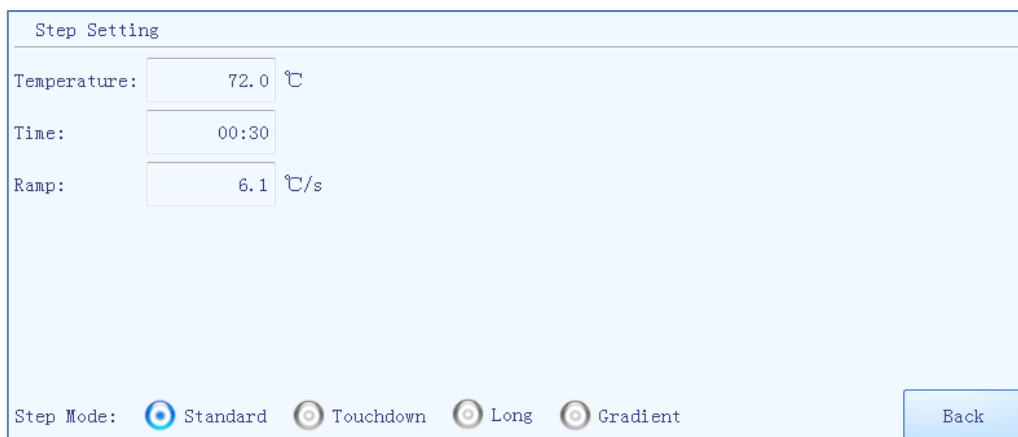

Figure E-3.4. Temperature Setting Sub-tab - Step Edit Window - Standard Step Mode

- 1) The **Standard** step mode option is selected by default.
- User can press the input boxes of **Temperature**, **Time** and **Ramp** to edit the corresponding parameters for the current standard step, as shown in figure E-3.4a.
- **Temperature**: the temperature in °C, which is to be held for a defined time.
 - **Time**: the time for which the temperature is to be held.
 - **Ramp**: the rate of temperature change in °C per second.

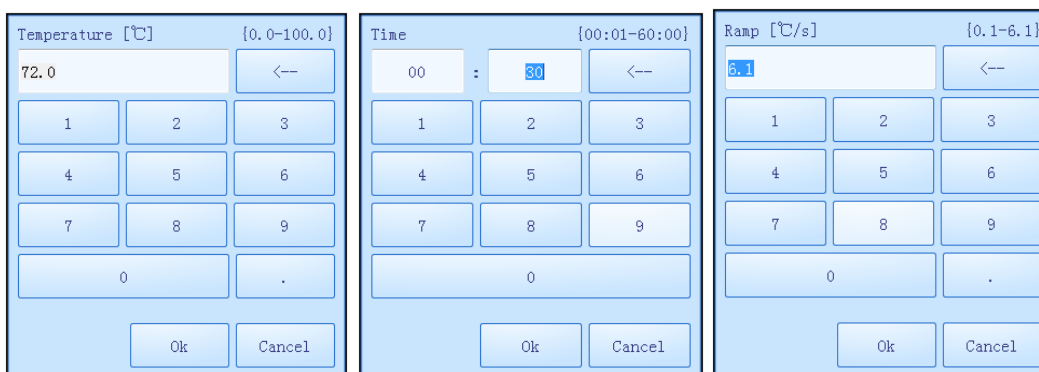

Figure E-3.4a. Step Edit Window - Standard Step Parameter Setting

- ❗ **Reminding**: the temperature setting range is 0.0°C ~100.0°C.
- ❗ **Reminding**: the time setting range is 1s~60min.

! **Reminding:** the ramp setting range is 0.1°C/s~6.1°C/s.

2) If the **Touchdown** step mode option is selected, the step edit window will be shown as figure E-3.5.

The screenshot shows a 'Step Setting' dialog box with the following parameters:

- Initial Temp.: 72.0 °C
- Target Temp.: 50.0 °C
- Time: 00:30
- Delta Temp.: 1.0 °C/Cycle
- Ramp: 6.1 °C/s
- Start Cycle: 1

At the bottom, the 'Step Mode' is set to 'Touchdown' (indicated by a blue radio button). Other modes include 'Standard', 'Long', and 'Gradient'. A 'Back' button is located in the bottom right corner.

Figure E-3.5. Temperature Setting Sub-tab - Step Edit Window - Touchdown Step Mode

- ▶ The touchdown step mode allows the temperature program to change the annealing step temperature from the initial temperature to the target temperature as the cycling proceeds.
- ▶ User can press the input boxes of **Initial Temp.**, **Target Temp.**, **Delta Temp.** and **Start Cycle** to edit the corresponding parameters for current touchdown step, as shown in E-3.5a.

The figure shows two examples of the numeric keypad interface used for editing temperature values:

- Left Screenshot:** The 'Initial Temp. [°C]' field is active, showing the value 72.0. The keypad includes digits 0-9, a decimal point, and a left arrow key. 'Ok' and 'Cancel' buttons are at the bottom.
- Right Screenshot:** The 'Temperature [°C]' field is active, showing the value 50.0. The keypad and buttons are identical to the left screenshot.

Figure E-3.5a. Step Edit Window - Touchdown Step Parameter Setting

- **Initial Temp.:** the initial value of annealing temperature change range.
- **Target Temp.:** the target value of annealing temperature change range.
- **Delta Temp.:** the temperature change(°C) per cycle.
- **Start Cycle:** the cycle number after which the temperature change is started.
- ❗ **Reminding:** the initial and target temperature setting range is 35.0°C ~100.0°C.
- ❗ **Reminding:** the delta temperature setting range is 0.1°C ~5.0°C.
- ❗ **Reminding:** the star cycle range is 1~ max cycle number of the current stage.
- ❗ **Reminding:** the other parameter settings are same with the standard step mode.

3) If the **Long** step mode option is selected, the step edit window will be shown as E-3.6.

Figure E-3.6. Step Edit Window - Long Step Mode

- ▶ The long step mode allows the temperature program to change the elongation step temperature holding time from the initial time to the target time as the cycling proceeds.
- ▶ User can press the input boxes of **Initial Time**, **Target Time**, **Delta Time** and **Start Cycle** to edit the corresponding parameters for the current long step, as shown in figure E-3.6a.

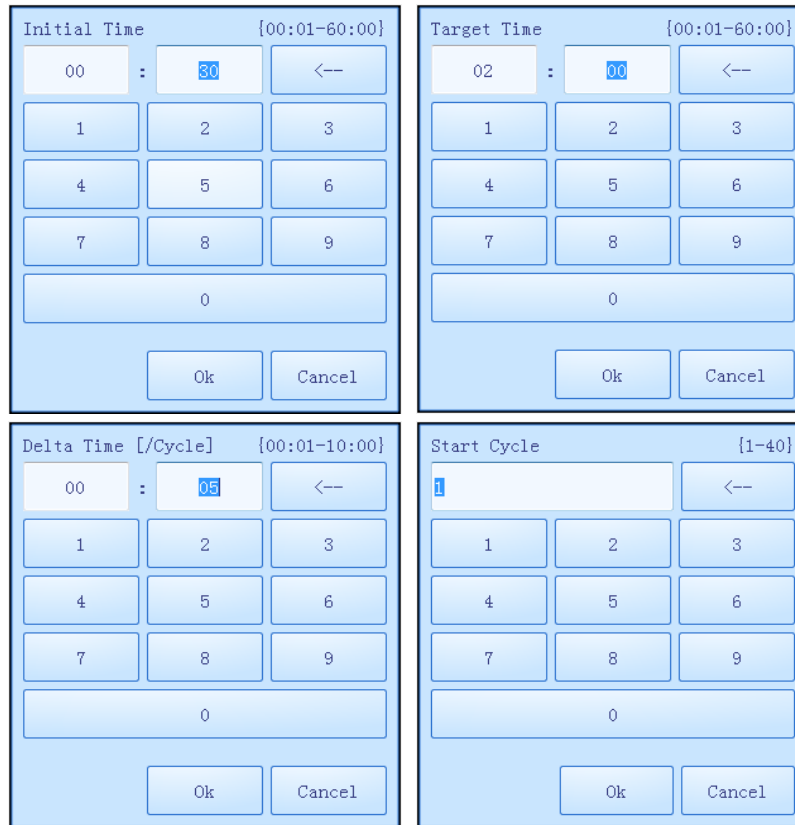

Figure E-3.6a. Step Edit Window - Long Step Parameter Setting

- **Initial Time:** the initial value of the elongation time change range.
 - **Target Time:** the target value of the elongation time change range.
 - **Delta Time:** the temperature change(°C) per cycle.
 - **Start Cycle:** the cycle number after which the time change is started.
- ⚠ **Reminding:** the initial and target time setting range is 1s~60min.
 - ⚠ **Reminding:** the delta time setting range is 1s~10min.
 - ⚠ **Reminding:** the star cycle range is 1~ max cycle number of the current stage.
 - ⚠ **Reminding:** the other parameter settings are same with the standard step mode.

- 4) If the **Gradient** step mode option is selected, the step edit window will be shown as figure E-3.7.

Step Setting

Time: 00:30 Temp. Center: 72.0 °C

Ramp: 6.1 °C/s Temp. Offset: 5.0 °C

Details

Step Mode: Standard Touchdown Long Gradient

Back

Figure E-3.7. Temperature Setting Sub-tab - Step Edit Window - Gradient Step Mode

- ▶ The gradient step mode allows the Gentier sample to adopt different temperatures. After setting the temperature center value and the temperature offset value for the current gradient step, the system will automatically calculate the gradient temperatures.
- ▶ User can press the input boxes of **Temp. Center** and **Temp. Offset** to edit the corresponding parameters for the current gradient step. User can also and press < **Details** > to view the specific gradient temperatures of each column, as shown in figure E-3.7a.

Temp. Center [°C] {35.5-99.5}

72.0 <--

1 2 3

4 5 6

7 8 9

0 .

Ok Cancel

Temp. Offset [°C] {0.5-20.0}

5.0 <--

1 2 3

4 5 6

7 8 9

0 .

Ok Cancel

Column 1 67.0°C

Column 2 67.5°C

Column 3 68.0°C

Column 4 69.0°C

Column 5 70.3°C

Column 6 71.5°C

Column 7 72.5°C

Column 8 73.8°C

Column 9 75.0°C

Column10 76.0°C

Column11 76.5°C

Column12 77.0°C

Close

Figure E-3.7a. Step Edit Window - Gradient Step Parameter Setting

- **Temp. Center:** the center value of the temperature grading range.

- **Temp. Offset:** the offset value of the temperature grading range.

- ❗ **Reminding:** the temperature center setting range is 35.5°C ~99.5°C.

- ❗ **Reminding:** the temperature offset setting range is 0.5°C ~20.0°C.

- ❗ **Reminding:** the other parameter settings are same with the standard step mode.

5) If the current step is the last step of a melting stage, the step setting window of this step is as shown in figure E-3.8.



Figure E-3.8. Step Edit Window - Melting Step Mode

► The melting stage allows the instrument system to read fluorescence signals after each temperature increment. User can press the input boxes of **Increment** to edit the temperature increment for the current melting step, as shown in figure E-3.8a.

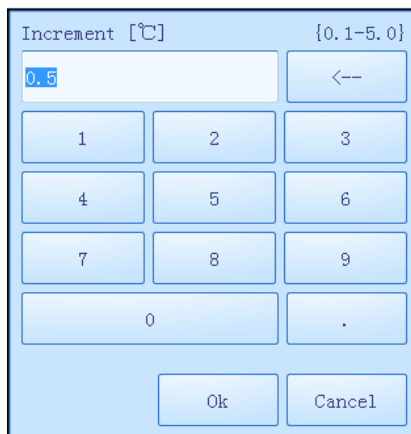

Figure E-3.8a. Step Edit Window - Melting Step Parameter Setting

- **Increment:** the temperature change(°C) after which the system will read the fluorescence.

⚠ **Reminding:** the temperature increment setting range is 0.1°C - 5.0°C.

- 6) If the current step is the last step of a continuous melting stage, the step setting window of this step is as shown in figure E-3.9.

Figure E-3.9. Step Edit Window - Continuous Melting Step Mode

- ▶ Continuous melting stage allows the instrument system to read fluorescence more frequently, user can press the input boxes of **Readings** to set the fluorescence reading times per °C for the current continuous melting step, as shown in figure E-3.9a.

- **Readings:** the fluorescence reading times per °C.

⚠ **Reminding:** the reading frequency setting range is 2readings/°C - 15readings/°C.

Figure E-3.9a. Step Edit Window - Continuous Melting Step Parameter Setting

2.2.2 Fluorescence Setting

The **Fluorescence Setting** sub-tab on the run setting interface is as shown in figure E-4.

exp-20210113140606 14:11
2021/01/13

Experiment File Run Setting Run Monitoring General Setting

Temperature Setting Fluorescence Setting

Channel	Dye	Excitation/Emission
<input checked="" type="checkbox"/> 1	FAM ▾	465/510
<input type="checkbox"/> 2	HEX ▾	527/563
<input type="checkbox"/> 3	Texas Red ▾	580/616
<input type="checkbox"/> 4	Cy5	632/664
<input type="checkbox"/> 5	Alexa Fluor 680	680/730
<input type="checkbox"/> 6	FRET	465/616

> Add stage
> Move stage up
> Edit step

Figure E-4. Run Setting Interface - Fluorescence Setting Sub-tab

- ▶ User can set the fluorescence channel and dyes for the current experiment in the **Fluorescence Setting** sub-tab.
- User can check the corresponding check box in the **Channel** column to set the fluorescence channel for the current experiment (channel 1-6 for Gentier 96E&96T or channel 1-4 for Gentier 96R);
- User can press the corresponding icon in the **Dye** column and select the proper dye from the drop-down list;
- User can view the excitation and emission wave length of the corresponding channel in the **Excitation/Emission** column.

2.3 Run Monitoring

After finishing the experiment setting, user can press the <  **Run Experiment** > function key to start running the current experiment, the system will enter the run monitoring interface, which is consisted of three parts: run status bar, run monitoring option bar and run monitoring diagram, as shown in figure E-5.



Figure E-5. System Software – Run Monitoring Interface

1. **Run Status Bar:** displays the real-time running status of the current experiment, includes **Remaining Time, Stage, Cycle** and **Step**.
2. **Run Monitoring Option Bar:** user can select **Fluorescence** or **Temperature** option in the run monitoring option bar to monitor the corresponding content of the current experiment.
 - ▶ User can press the **Fluorescence** option to monitor the real-time amplification curve, melting curve and fluorescence heat map of the current experiment.
 - ▶ User can press the **Temperature** option to monitor real-time temperature program of the current experiment

3. Run Monitoring Diagram:

- If user select the **Fluorescence** option in the run monitoring option bar, user can press or keys below the run monitoring diagram to choose the monitor content, which can be the real-time **Amplification** curve, **Melting** curve or fluorescence **Heat Map** of the current experiment, as shown in figure E-5.1.
- a. The run monitoring diagram will display the real-time **Amplification** curve of the current experiment by default, as shown in figure E-5.1.

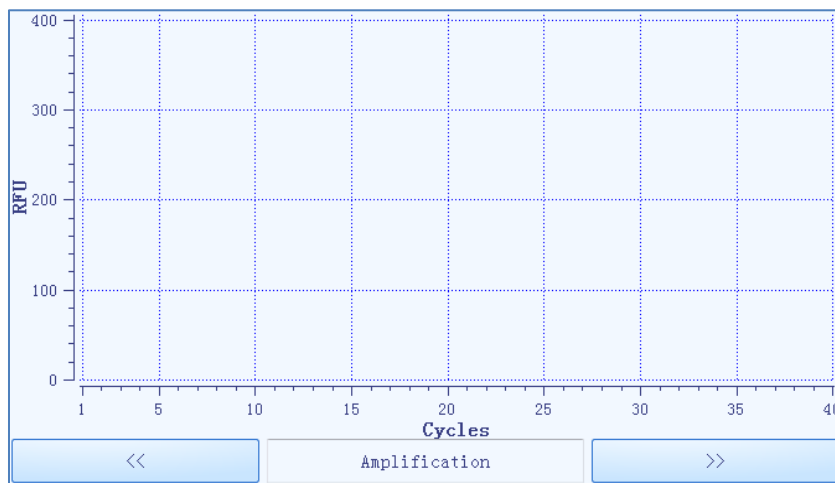

Figure E-5.1. Run Monitoring Diagram - Real-time Amplification Curve

- X axis represents the cycle number.
 - Y axis represents the Relative Fluorescence Unit (RFU).
 - User can press any dye under the **Fluorescence** option in the run monitoring option bar, and the run monitoring diagram will only display the corresponding real-time amplification curve.
- b. User can press key below the run monitoring diagram to monitor the real-time **Melting** curve of the current experiment, as shown in figure E-5.2.
- X axis represents the temperature.
 - Y axis represents the Relative Fluorescence Unit (RFU).
 - User can press any dye under the **Fluorescence** option in the run monitoring option bar, and the run monitoring diagram will only display the corresponding real-time melting curve.

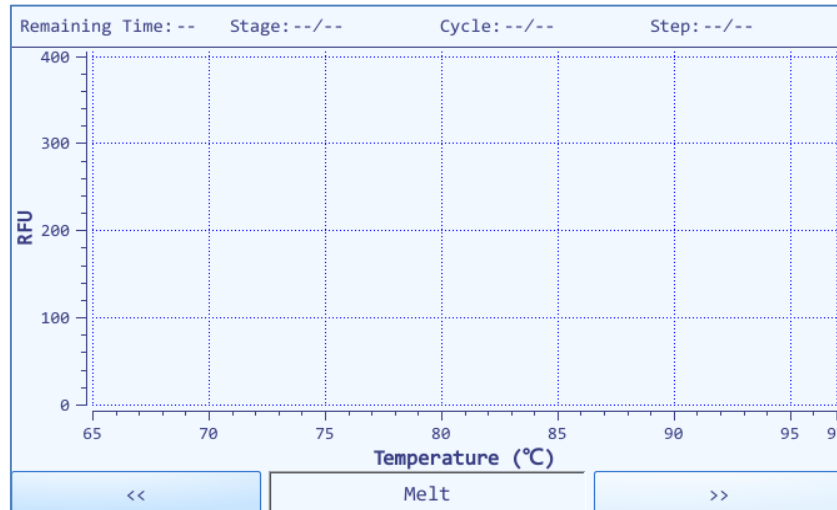

Figure E-5.2. Run Monitoring Diagram - Real-time Melting Curve

- c. User can press key below the run monitoring diagram to monitor the fluorescence **Heat Map** of the current experiment, as shown in figure E-5.3.

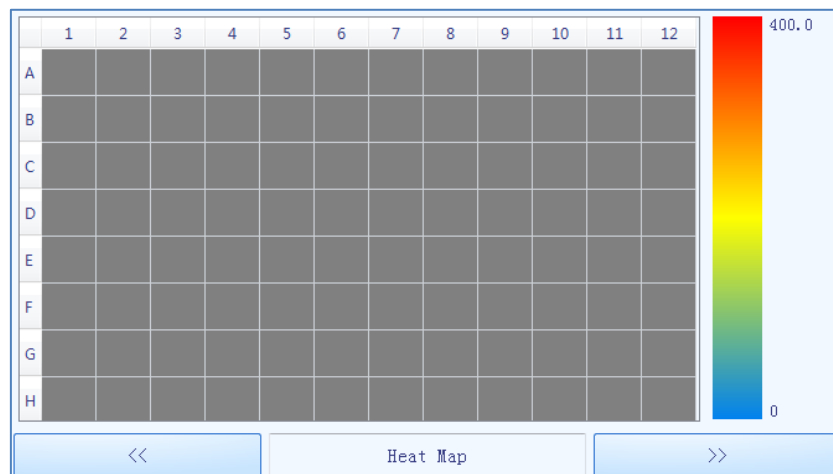

Figure E-5.3. Run Monitoring Diagram - Heat Map

- The fluorescence heat map displays the 96 sample wells corresponding to the sample block;
 - The color bar on the right side of fluorescence heat map displays the change tendency of fluorescence intensity and its corresponding color;
- If user select the **Temperature** option in the run monitoring option bar, run monitoring diagram will display the temperature program of the current experiment, as shown in figure E-5.4.

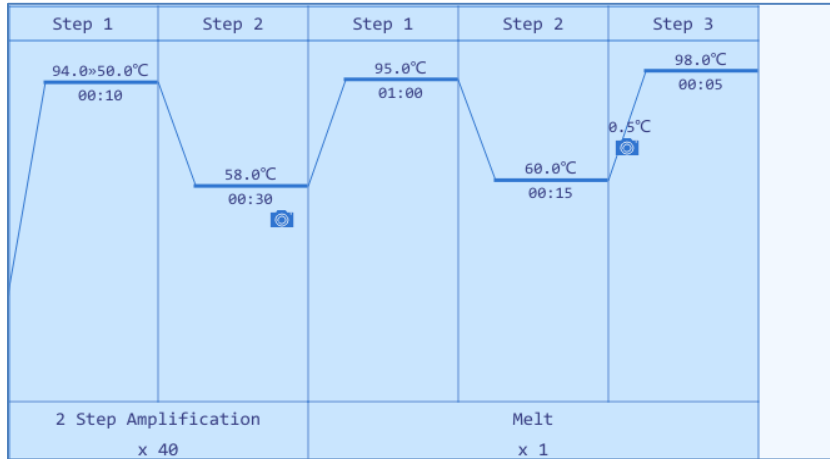

Figure E-5.4. Run Monitoring Diagram - Temperature Program

2.4 General Setting

The General Setting tab consists of **Instrument**, **Configuration** and **Service** three sub-tabs.

2.4.1 Instrument Sub-tab

The General Setting tab displays the **Instrument** sub-tab by default, as shown in figure E-6.1.

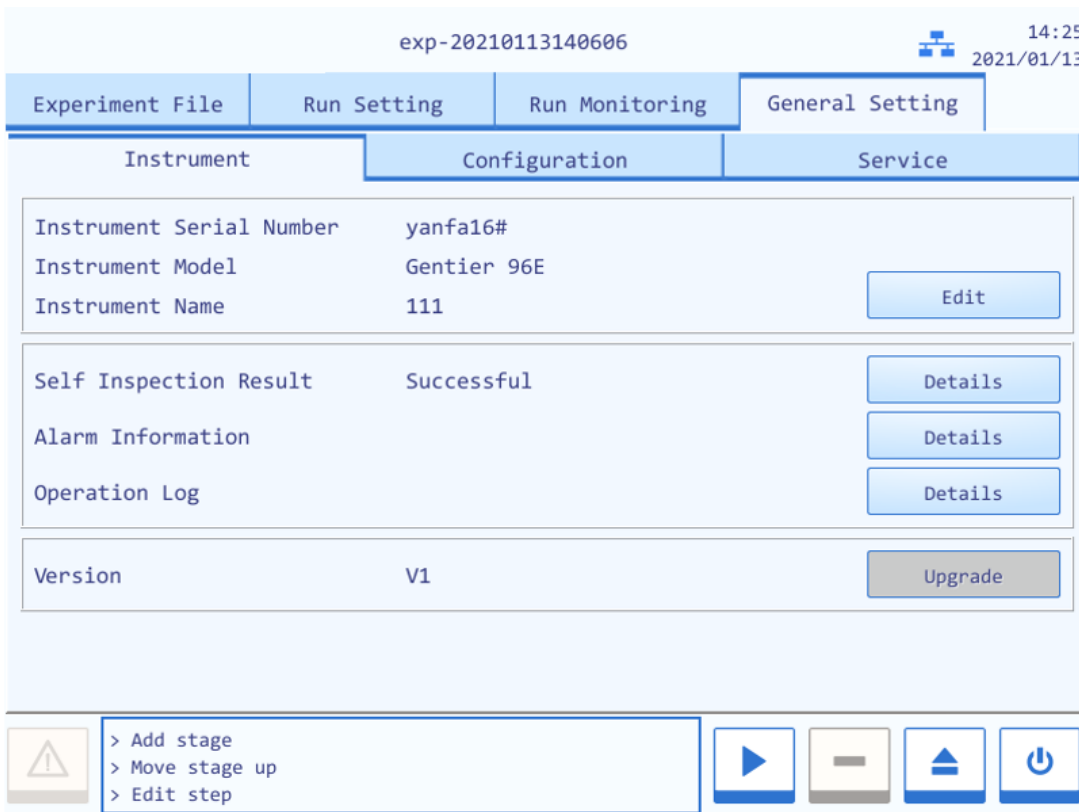

Figure E- 6.1. Instrument Software – General Setting Tab - Instrument Sub-tab

Introduction to Instrument sub-tab

- ▶ **Instrument Serial Number:** display the factory serial number of the current Gentier instrument.
- ▶ **Instrument Model:** display the current Gentier instrument model.
- ▶ **Instrument Name:** display the name of the current Gentier instrument, user can press < **Edit** > and the instrument software will pop up the instrument name edit window, as shown in figure E-6.1a.



Figure E-6.1a. Configuration Sub-tab - Instrument Name Edit Window

- ▶ **Self-Inspection:** display the latest self-inspection result of the current Gentier instrument, user can press < **Details** > to view detailed self-inspection information.
 - ▶ **Alarm Information:** user can press < **Details** > to view the detailed alarm information occurred during the self-inspection and experiment running.
 - ▶ **Operation Log:** user can press < **Details** > to view all the operations have been executed on the current Gentier instrument.
 - ▶ **Version:** user could press < **Details** > to view the system version information of the current Gentier instrument and the < **Upgrade** > is used for instrument system upgrade.
- ⚠ **Reminding:** the instrument system upgrade should be executed by professional engineer or under professional guidelines.
-

2.4.2 Configuration Sub-tab

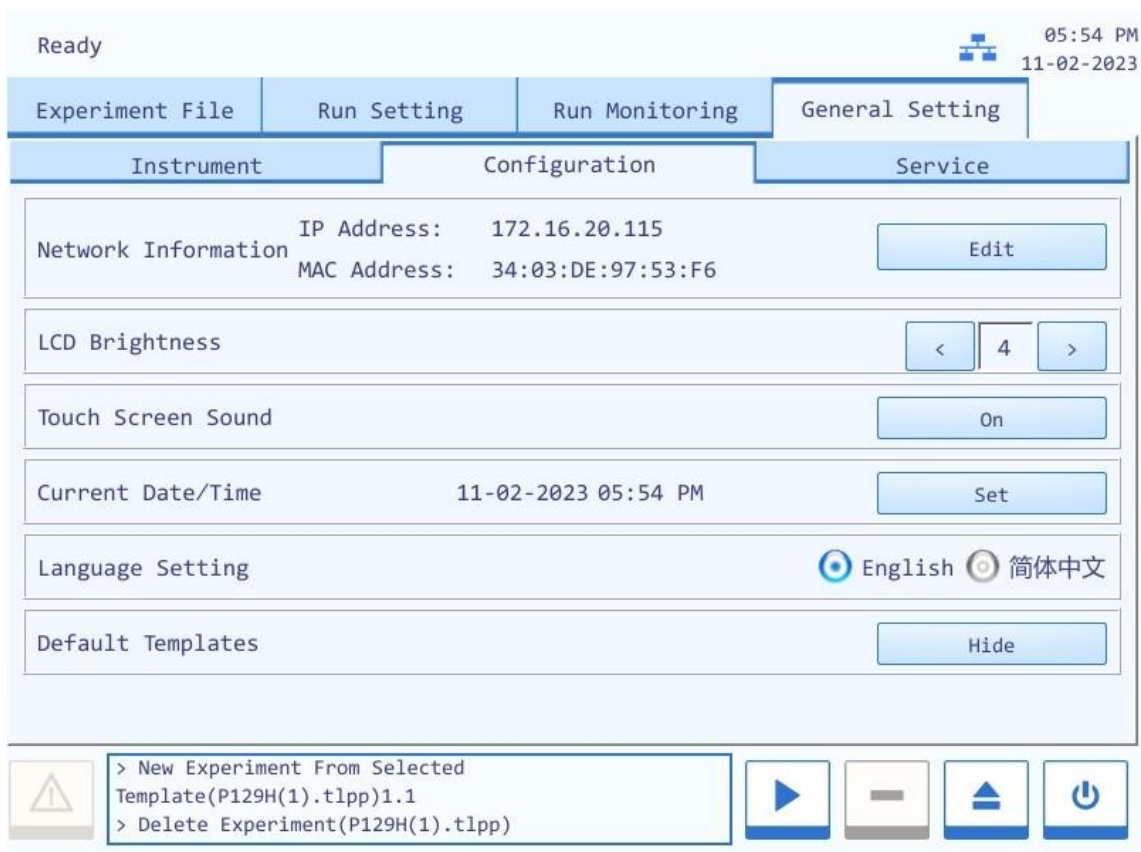

Figure E- 6.2. General Setting Tab - Configuration Sub-tab

Introduction to Configuration Sub-tab

- **Network Information:** display the network information of the current Gentier instrument. User can press < **Edit** > and the instrument software will pop up the network information window, as shown in figure E-6.2a.

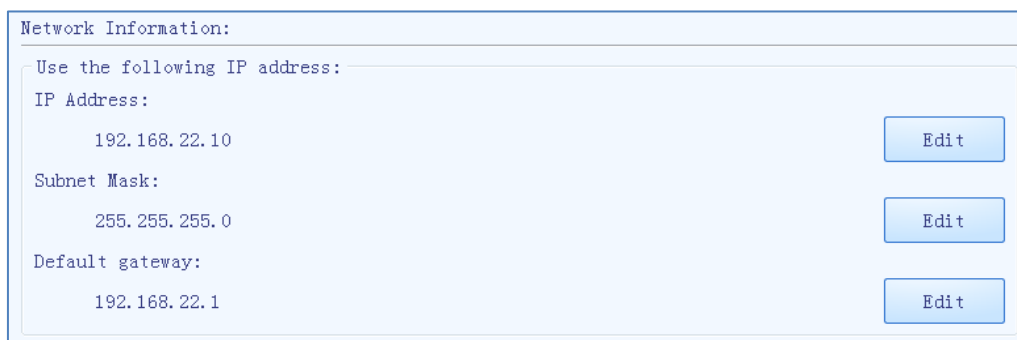



Figure E-6.2a. Configuration Sub-tab - Network Information Window

- In the IP Setting box, user can view all the network IP addresses, or press < **Edit** > to modify the corresponding parameter.
 - User can press < **Default** > to recover the default network IP settings of the current instrument.
 - User can press < **Back** > to turn back to the configuration tab.
- ▶ **LCD Brightness:** user could press  and  icons to adjust the screen brightness (dark: 1 ~ bright: 5).
- ▶ **Touch Screen Sound:** user could press < **Open** > or < **Close** > to decide whether to enable the touch screen sound.
- ▶ **Current Date/Time:** user can press < **Set** > to set the date and time displayed on the current Gentier instrument, the date/time setting window will pop up as shown in E-6.2b.

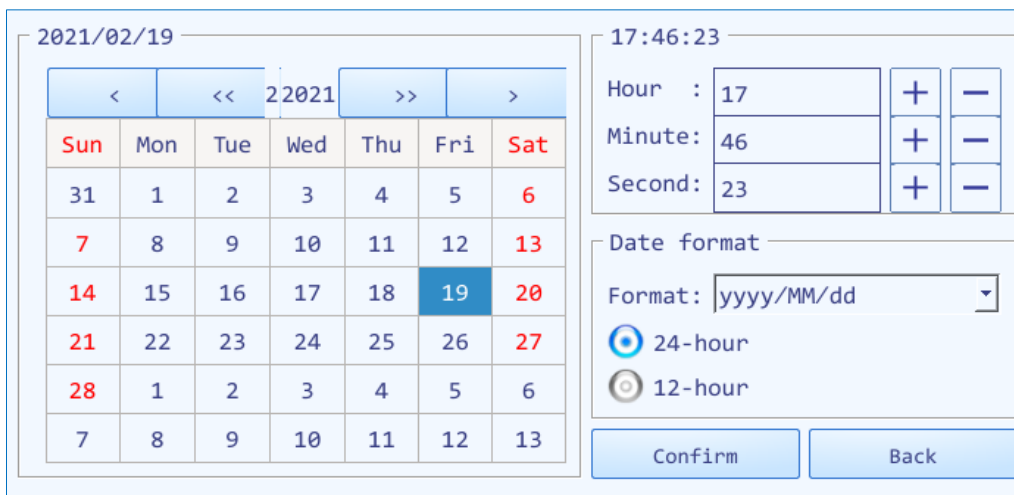







Figure E-6.2b. Instrument Sub-tab - Date/Time Setting Window

- User can press  and  icons to set the displayed year.
 - User can press  and  icons to set the displayed month.
 - User can set the displayed date on the calendar.
 - User can press  and  icons to set the displayed time, including Hour, Minute and Second.
- In the **Date Format** setting box, user can set the displayed date format in the **Format** drop-down list; user can also press **24-hour** or **12-hour** option to set the displayed time format.

- User can press < **Confirm** > to confirm the date and time setting;
- User can press < **Back** > to return to the **Instrument** sub-tab interface.
- ▶ **Language Setting:** user could set the instrument system language. The two options provided are **English** and **Simplified Chinese**.
- ▶ **Default Template:** user could press <**Hide**> to hide the default template in the experiment file interface.

2.4.3 Service Sub-tab

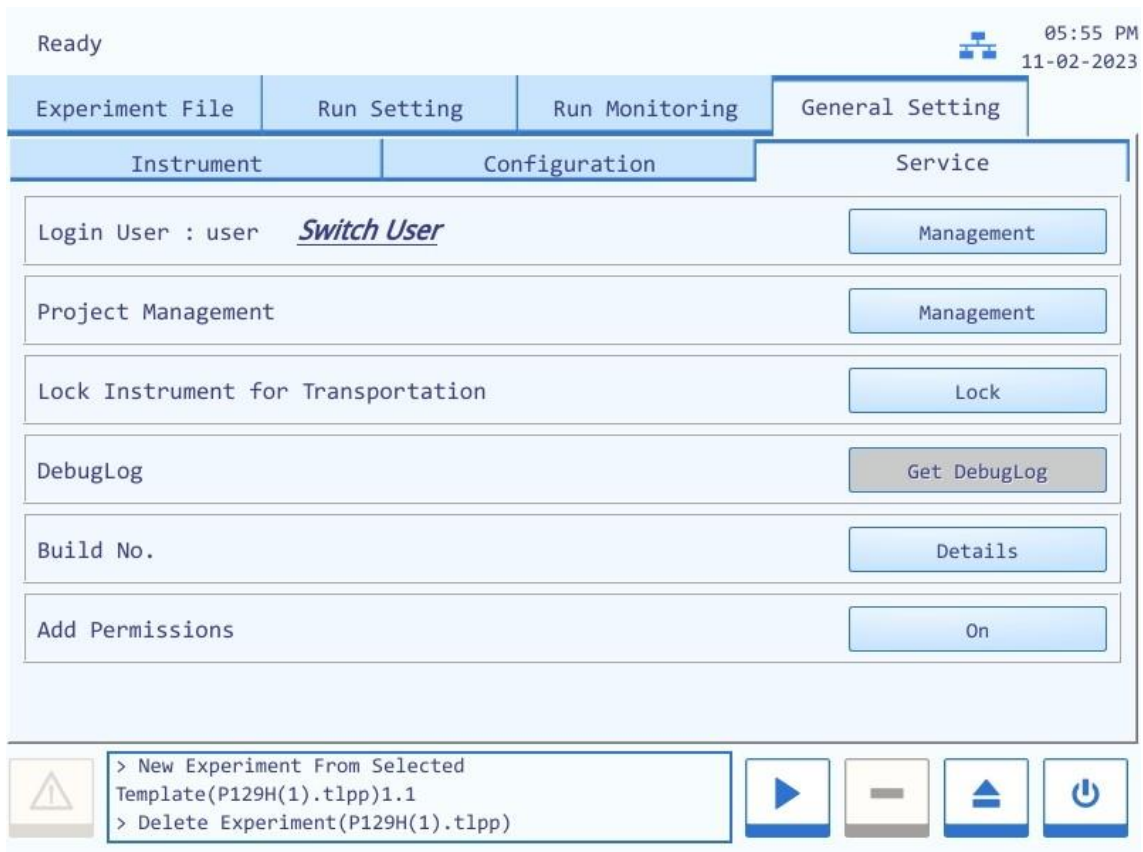



Figure E- 6.3. General Setting Tab - Service Sub-tab

Introduction to Service sub-tab

- ▶ **Login User:** user could press <**Switch User**> to switch user account. User could press <**Management**> to review the user list and relevant information. User could also change

password in **<Management>** interface.

When the admin user is logged in, admin can add new user, change instrument name, clear memory and etc.





- ▶ **Project Management:** user can import project template by clicking **Project Management**.
 - ▶ **Lock Instrument for Transportation:** user can press **< Lock >** and the system software will guide the operator to lock the transport lock. For detailed installation steps of transport, please refer to *F-3.2 Gentier Instrument Transport Lock*.
 - ▶ **Debug Log:** user could connect an USB drive to the Gentier instrument and press **< Get Debug Log >** to download all the log file of the current Gentier instrument, this will help our professional engineer to get the relative information in case the instrument require maintenance.
 - ▶ **Build No. :** user could press **< Details >** to view the build number of the current instrument.
 - ▶ **Add Permissions:** press **< Add Permissions >**, the create, edit, import, outport and delete experiment operations will be needed to input password.
-  **Reminding:** no person except the professional engineers from our company is allowed to enter the debug mode.
-

F. Instrument Cleaning and Maintenance

Under proper use condition, the Gentier instrument requires little maintenance. However, the Gentier instrument should be cleaned and maintained on a regular schedule for long time and constant use. This section includes the information on cleaning and maintenance of the Gentier instrument.

1. Instrument Cleaning Operation Instructions

The Gentier instrument should be cleaned on a regular schedule (every other month), please carefully read the following instructions before cleaning the instrument.

-  **Prohibit:** never clean the instrument when it is electrified.
-  **Prohibit:** never pour water or other solutions in into the sample block, loading platform or any interior parts of the instrument. Fluids can cause electrical shock when the instrument is electrified.
-  **Caution:** ethanol is a flammable and volatile liquid, it's exposure may irritate eyes, skin and respiratory tract, and may lead to central nervous system hypofunction and liver damage. Please wear appropriate protective goggles, clothing and gloves, when using ethanol to clean.
-  **High-Temp:** the sample block may produce high temperature during running, do not clean the sample block until it reaches the room temperature.
-  **Biohazard:** please regard all samples as potential biohazard materials, universal safety precautions should be taken when handling or processing samples. Samples pills should be immediately disinfected with an appropriate disinfectant solution to avoid equipment contamination or user' personnel injury.

1.1 Clean Instrument Shell

1st step: switch off the instrument and unplug the power cord;

2nd step: clean the instrument shell with a piece of damp, soft cloth, and if needed, please rinse the cloth with mild commercial detergent for cleaning.

 **Prohibit:** do not spray the detergent directly on the instrument, as malfunctions of the electronics or may occur.

 **Caution:** please do not use organic or strong detergent to clean the instrument shell, which may ruin the surface coating.

1.2 Clean Touch Screen

1st step: Switch off the instrument and unplug the power cord;

2nd step: Gently wipe the touch screen with a piece of dry, soft cloth to remove dust, oil or fingerprints.

3rd step: If the touch screen is still not clean, use a piece of damp, soft cloth that moistened with low concentration isopropanol or ethanol to clean the touch screen in a gentle motion.

 **Prohibit:** do not spray the detergent directly on the touch screen, as malfunctions of the electronics or may occur.

 **Caution:** do not use abrasive detergent or rough material, as they may scratch the touch screen.

1.3 Clean Loading Platform and Sample Block

1st step: Switch off the instrument and unplug the power cord;

2nd step: Open the loading platform and clean its surface with a piece of damp, soft cloth, and if needed, please rinse the cloth with mild commercial detergent.

3rd step: Clean the sample block wells with the degreased cotton swab moistened with ethanol to ensure the firm contact and good thermal conductivity between the consumables and the wall of block well.

 **Prohibit:** do not spray the detergent directly on the sample block, as malfunctions of the electronics or may occur.

 **Caution:** do not close the hot lid before the sample block is completely dry.

2. Instrument Maintenance Operation Instructions

2.1 Maintain Sufficient Air Flow

The placing area of Gentier instrument should be checked regularly, as it requires sufficient air flow to precisely reach the correct target temperature. Please ensure that the air flow is unrestricted and other items around the instrument do not interfering with the air flow.

2.2 Maintain Stable Power Supply.

The Gentier instrument requires stable power supply for proper functioning, therefore its power supply should be checked regularly to ensure the consistent of instrument required voltage and the power supply voltage (allowable deviation $\pm 10\%$). And make sure that the rated load of receptacle is no less than the requirement of instrument.

2.3 Maintain Instrument Cleanliness

Contamination of loading platform, sample block or optical parts can interfere with thermal cycling and data collection.

Avoid contaminating the Gentier instrument:

- Always clean the outside surface of consumables before placing them in the sample block.
- Clean the loading platform and the sample block periodically to prevent the buildup of dirt, biohazardous materials or solutions.
- Always seal the consumables with sealing film before running the experiment.

 **Caution:** Never place a consumable with open or leak cap in the sample block. The reagents may escape during heating and cover the sample block, hot lid and loading platform.

 **Caution:** Never run a PCR reaction with volatile reagents that could contaminate the sample block, hot lid and loading platform.

 **Caution:** In case the instrument will not be used for a long time, unplug it and cover the instrument with a soft cloth or plastic bags to prevent dust from entering.

2.4 Replace Fuse Tube

The fuse tube (type F10AH250V) of Gentier instrument is located in the fuse tube box near the power outlet at rear of the instrument. Before replacing the fuse tube, please switch off the instrument and unplug the power plug, use a screwdriver to pry open the fuse tube box. Then substitute the old fuse tube with an equal one, as shown in figure F-1.

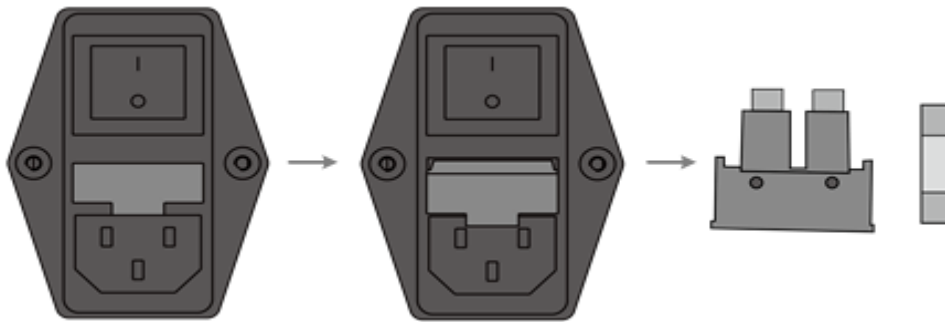

Figure F-1. Replace the fuse tube

⚠ Reminding: in case there is no display on the screen after starting up the Gentier instrument, please check the fuse tube.

⚠ Caution: improper fuse tube may lead to circuit system damage, even fire.

2.5 Replace Dust Filter Foam

In order to avoid the dust particles from entering the Gentier instrument, every cooling fan the instrument is equipped with dust-proof net. Please replace the dust filter foam within the dust-proof net on a regular schedule (every six months), as shown in figure F-2. In case there are dusts accumulated on the cooling fan, please clean it with a vacuum cleaner.

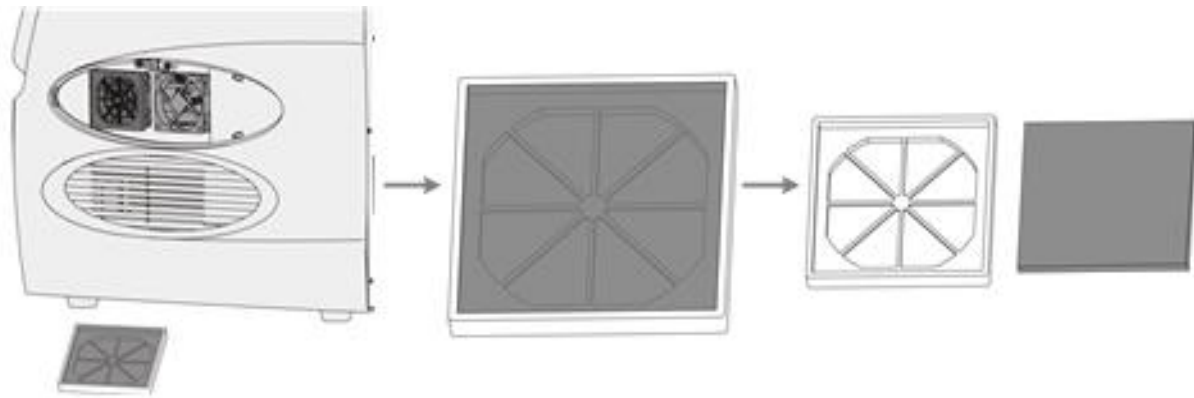

Figure F-2. Replace Dust Filter Foam

3. Transportation or Return to Factory

3.1 Instrument Disinfection

In case the Gentier instrument will be moved to another lab or needed to return to the after-sale service department for maintenance, please first disinfection the instrument and fill in the disinfection certificate.

The disinfection process of Gentier instrument is listed as follows:

- ▶ Please wear protective clothing and medical disposable gloves;
- ▶ Open the loading platform and get all consumables out of the sample block;
- ▶ Switch off the instrument and unplug the power cord;
- ▶ Prepare the detergent (lab routine disinfectant), wet the cotton cloth and degreased cotton swabs with the prepared detergent;
- ▶ Clean the loading platform with the cotton cloth, clean the sample block well with the degreased cotton swabs, and leave the loading platform open until it is dry;
- ▶ Clean the loading platform and the sample block again with 75% ethanol;
- ▶ Clean the instrument shell with mild detergent;
- ▶ Open the loading platform and leave the instrument under UV light for 1 hour disinfection.

3.2 Gentier Instrument Transportation Locking

In order to protect the Gentier instrument during transportation, avoid the transport damages. Please follow the instructions listed below to complete the transportation locking operation.

1st Step: press <  **Open/Close Sample Cabin** > function key on the instrument touch screen, the sample cabin drawer will be drawn out slowly. Please load empty PCR 96-well plate on the sample module or load empty PCR 8-stirp tube in column 2, 5, 8 and 11, as shown in figure F-3.

2nd Step: press the <  **Open/Close** > function key again to close the loading platform.

3rd Step: Open the **General Setting tab > Service sub-tab** and press < **Lock** > on the instrument system software, a prompt will pop up to help user complete the transport lock operation, as shown in figure F-4.

4th Step: Then press < **Next** >, the instrument system software will prompt user that the mechanical parts of the Gentier instrument will move and reset, as shown in figure F-5.

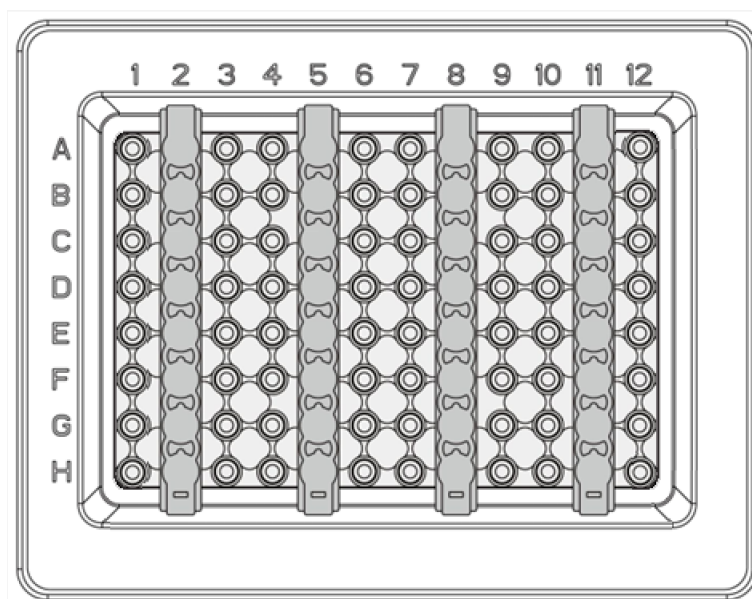

Figure F-3. Transport Locking Operation (1)



Figure F-4. Transport Locking Operation (2)



Figure F-5. Transport Locking Operation (3)

4th Step: press < **Lock** >, the mechanical parts of the Gentier instrument will move and reset. After this, the instrument will automatically shutdown and prompt user to install the transport lock, as shown in figure F-6.

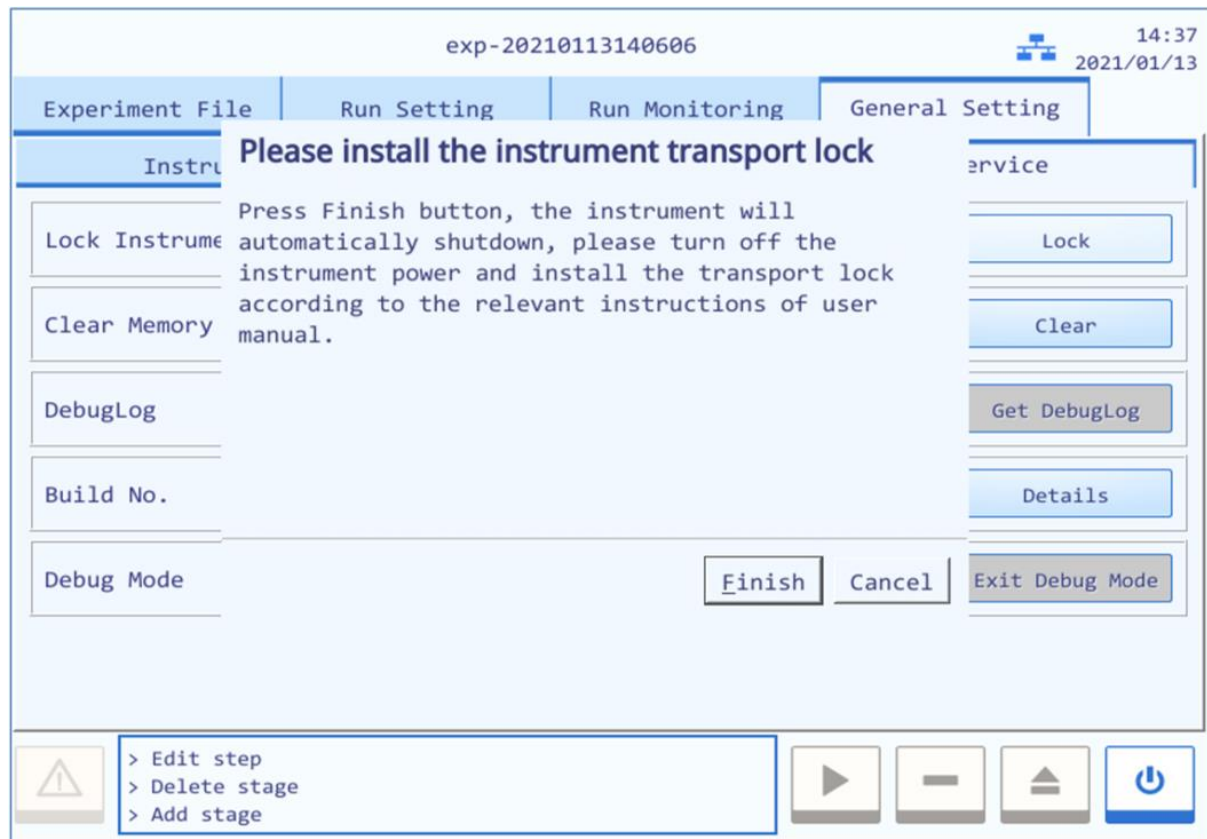

Figure F-6. Transport Locking Operation (4)

6th Step: please use appropriate tool to pry off and remove the removable air vent cover located on the right side of the instrument shell, as shown in figure F-7a.

7th Step: the transport lock screw should be fixed upon two cooling fans, as shown in figure F-7b. Please use screwdriver to fix the transport lock screw, as shown in figure F-7c.

8th Step: please install the air vent cover back to the original place on the instrument shell, as shown in figure F-7d.

⚠ Caution: please first shut down the instrument power and then install the transport lock.

⚠ Caution: unless it is noted in this manual, please do not loosen or remove any internal and external screws or other parts, otherwise it will break the instrument warranty and result in instrument misalignment.

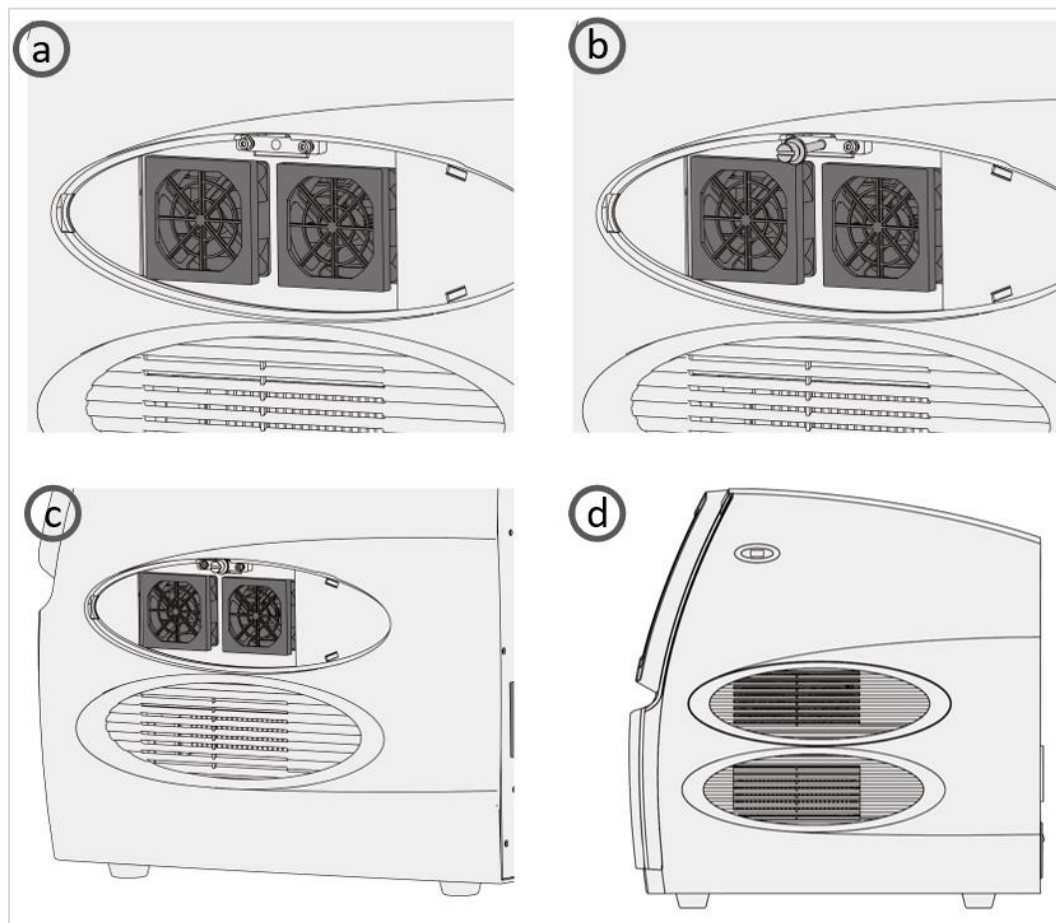

Figure F-7 Transport Locking Operation (5)

3.3 Product Packaging

Please use the original packaging materials to properly pack the Gentier instrument and its accessories in order to prevent the collision and oscillation during transportation. The specific packing steps of Gentier instrument are shown in figure F-8.

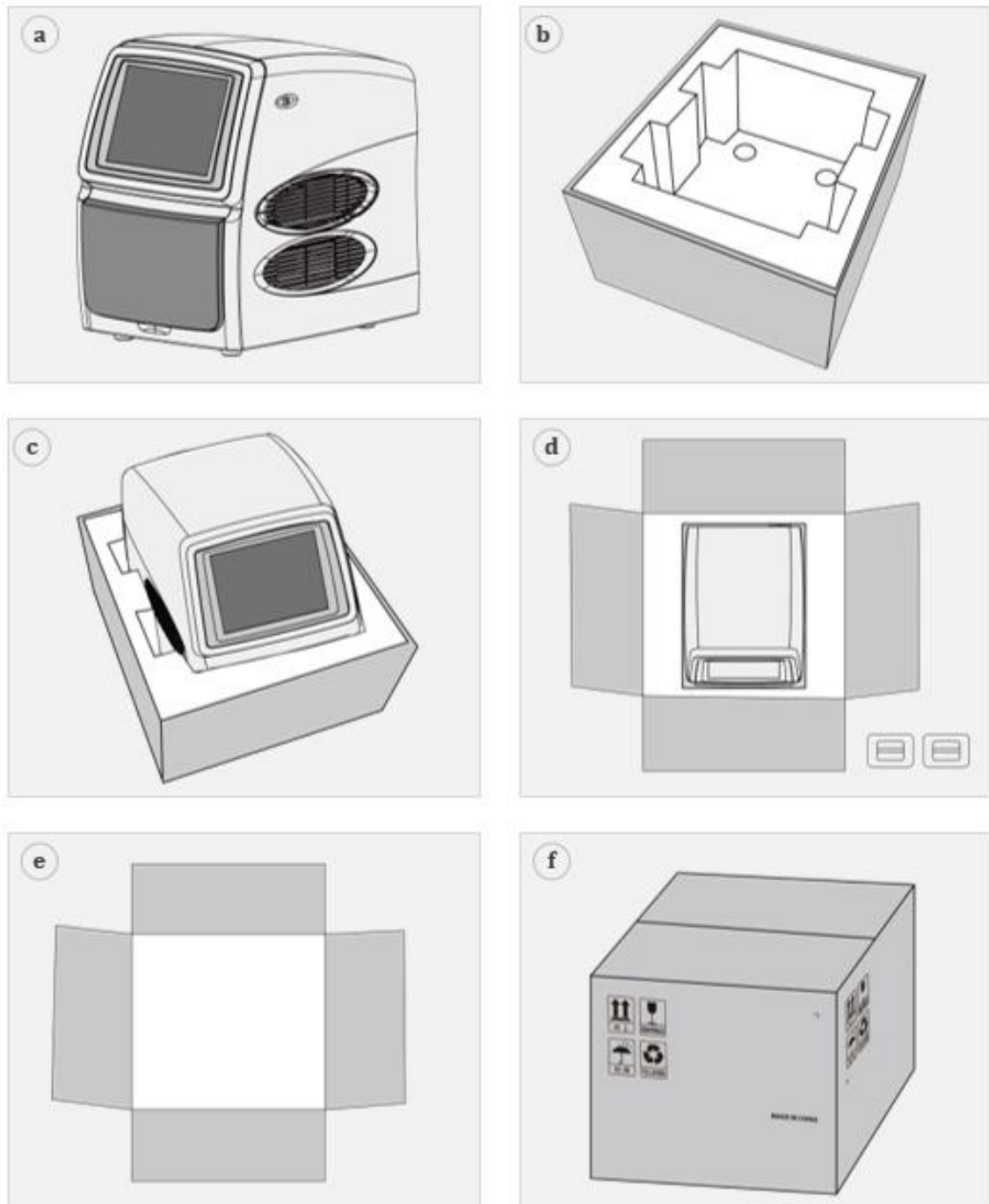

Figure F-8. The Packing Steps of Gentier Instrument

1st Step: pack the Gentier instrument with plastic bag, as shown in figure F-8a.

2nd Step: place the bottom protective foam into the bottom carton, as shown in figure F-8b.

3rd Step insert the Gentier instrument into the protective foam, as shown in figure F-8c.

4th Step: cover the bottom carton with the top carton, and fix them with four plastic buckles on both sides of the carton, as shown in figure F-8d.

5th Step: put the accessories inside the carton and place the top protective foam on the Gentier instrument, as shown in figure F-8e.

6th Step: use wide adhesive tape to seal the top carton cover and pack the whole package with packing bands, as shown in figure F-8f.

 **Caution:** The original transport package of Gentier instrument is designed to reduce the instrument damage and ensure its transportation safety. Adopt other packaging materials will break the warranty, and **XATL Co., Ltd.** will not be responsible for damages as consequences of improper packaging that incurred during the transportation back to maintenance department.

 **Reminding:** the well packaged Gentier instrument can be transported by general means of transportation (with awnings).

4. Troubleshooting

In general, corrective instructions will be display along with the error messages by the application or instrument software. And under normal circumstances the software running errors can be solved by restarting the computer or the instrument system. This section describes the main possible errors of the Gentier Instrument together with possible causes and corrective instructions.

No.	Error	Possible Cause	Corrective Instructions
1	No display on the screen	Without power supply	Plug the power supply
		Power switch is on 'off' position	Switch on the power switch
		Unstable power cord connection	Connect the power cord again or renew the power cord
		Inappropriate power voltage	Adjust the scope of power voltage into a normal range
		Fuse tube damaged	Replace the fuse tube
		Others	Contact us
2	Boot screen display error message	The activation of system failed.	Please contact us and consult the maintenance engineer
		Power voltage too low	Ensure there is no other appliance or circuit in the same electric circuit.

3	System crashed or out of control	Improper operation	Restart the instrument system
		Others	Contact us
4	Temperature does not rise while heating	Check temperature control setting	Startup the temperature control
		Others	Contact us
5	No Experiment Results	Wrong operation process	Check the operation process and test again
		Quality problems of reagents	Renew the reagent and run the experiment again.
		Experiment settings do not meet the requirements (temperature is inappropriate or cycle number is not enough).	Reset the experiment procedure
		Others	Contact us
6	Abnormal ramp or incorrect temperature	Air vent is blocked	Clean up the air vent.
		Connecting lines are loose.	Contact us

 **Caution:** in case you cannot judge and eliminate these failures by yourself, please directly contact with our company.

 **Caution:** in case any of following situation occurs, please immediately cut off the power supply and contract us. We will arrange qualified maintenance personnel for processing.

- Any liquid has entered into the instrument;
- Abnormal sound or smell appears inside the instrument;
- Instrument is soaked with water or rain;
- Any housing damage caused by accidentally drop of the instrument;
- Obvious functional changes of instrument.

 **Reminding:** For a patient/user/third party in the European Union and in countries with similar regulatory regime (Regulation 2017/746/EU on IVD Medical Devices); if, during the use of this device or as a result of its use, a serious incident has occurred, please report it to the manufacturer and/or its authorized representative and to your national regulatory authority.

G. Contact Information



Xi'an Tianlong Science and Technology Co., Ltd.

No.4266, Shanglin Road, Weiyang District, Xi'an, 710021, Shaanxi, P.R. China

Postcode:710021

Company Tel: +86-29-82682132

Company Fax: + 86-29-82216680

Email Address: inquiry@medtl.com

Website Address: www.medtl.net

SUNGO Europe B.V.



Fascinatio Boulevard 522, Unit 1.7, 2909VA Capelle aan den IJssel, The Netherlands.

Tel: +31(0)10 3034500; +31(0)2021 11106

Email Address: ec.rep@sungogroup.com

Appendix 1 - Product Accessories list

No.	List	Qty.	Replacement Period	Remark
1	Power cord	1	Replace after damage	1.5m
2	Network cable	1	Replace after damage	3.0m
3	USB Flash Disk for Application Installation	1	Depends on service status and OEM application update	FAT32
4	User Manual	1	/	
5	Certification	1	/	
6	Packing list	1	/	
7	Warranty card	1	/	
8	Fuse tube	2	After fuse tube broken	F10AH 250V
9	Sponge Filter	3	Half Year	6cm × 6cm



TIANLONG

Xi'an Tianlong Science and Technology Co.,Ltd.

Add: No.4266, Shanglin Road, Weiyang District, Xi'an, 710021, Shaanxi, P.R. China

Tel: +86-29-8268 2132

Fax: +86-29-8221 6680

<https://www.medtl.net>
