

Bring
Technology
to Life 



Automatic Nucleic Acid Extractor

Libex



USER MANUAL

Xi'an Tianlong Science and Technology Co., Ltd.

Automatic Nucleic Acid Extractor

User Manual

Created by Xi'an Tianlong Science and Technology Co. Ltd.

Disclaimer and Copyright

Copyright ©2015-2023 **Xi'an Tianlong Science and Technology Co., Ltd.** (hereinafter referred to as **XATL Co., Ltd.**). All rights reserved.

All contents of this manual (including but not limited to text, trademark, logo, buttons, icons, graphics, tables, data, etc.) are subject to the copyright and other intellectual property rights of **XATL Co., Ltd.** These materials shall not be reproduced in any form, neither mechanical nor electronic, nor translated into any other languages without the express written permission of **XATL Co., Ltd.**

Every effort has been made to ensure that all the information contained in this manual is correct at the time of publishing. However, **XATL Co., Ltd.** reserves the right to make any changes necessary. The contents of this manual are subject to change without prior notice at any time, and the updated revision prevails.

User Manual Version: V2.5

User Manual Revision Time: 12- Dec. -2023

Suitable Instrument Model: Libex



is a registered trademark for **Xi'an Tianlong Science and Technology Corporate Limited.**

Intended Use

The intended use of Libex Automatic Nucleic Acid Extractor is to complete the automatic extraction and purification of nucleic acid in various samples by using magnetic bead nucleic acid extraction reagent. The high purity nucleic acid extraction products are suitable for polymerase chain reaction, gene chip, gene hybridization, gene sequencing and other technologies, and can be applied to scientific research, clinical applications, food safety, forensic medicine and other application fields.

Special Declaration

Before installing and operating the Automatic Nucleic Acid Extractor, please read this manual carefully, observe the warnings and non-recommended functions. Also, please bear in mind the potential scope for misuse; it is advisable to draw attention to the possible consequences.

User Requirements

The Automatic Nucleic Acid Extractor must only be used by laboratory professionals trained in laboratory techniques, who have carefully read this manual.

Usage Precautions and Restrictions

1. Overview

The operation, maintenance and repair of **Automatic Nucleic Acid Extractor** shall strictly follow the basic safety specifications listed in this section and through this manual.

Non-observance of the instructions or performing any operations not stated herein may result in instrument damage or not working properly, and may also destroy the safety standards of design and manufacture as well as the expected application scope of the Automatic Nucleic Acid Extractor.











*The design of Automatic Nucleic Acid Extractor has sufficiently considered the security, **XATL Co., Ltd.** will not be responsible for any possible consequence caused by either not read or violate the instructions mentioned herein.*

Special Declaration

Usage precautions and restrictions provide very important information. Before install and use the Automatic Nucleic Acid Extractor, please read this manual carefully, observe the warnings and non-recommended functions. Also bear mind the potential scope for misuse; it is advisable to draw attention to the possible consequences.

2. Safety Symbol and Label

A. Safety Labels on Transport Package

Label	Description
	Fragile: the items inside are fragile, please handle with care.
	This Side Up: indicates the upward side of the transport package.
	Keep Dry: keep the transport package away from rain or any liquid.
	IVD Instrument: the instrument belongs to In Vitro Diagnostic equipment.
	CE Mark: indicates the instrument is in conformity with In Vitro Diagnostic Medical Devices Regulation (EU) 2017/746.
	Temperature Limit: indicates the temperature limits for the storage and transportation of package.
	Humidity Limit: indicates the humidity limits for the storage and transportation of package.
	Atmospheric Pressure Limit: indicates the atmospheric pressure limits for the storage and transportation of package.
	Max 2 Packages: it is prohibited to stack more than 2 layers for the storage and transportation of packages.
	Recycle: indicates the packaging materials are recyclable.
	Made in China: Indicates that the instrument originated in China.

B. Labels on the Automatic Nucleic Acid Extractor

The following table represents the labels on the Automatic Nucleic Acid Extractor and directly refers to the safe and proper operations of the instrument.

Icon	Description
	High-Temp This label is used to indicate potential hot instrument surfaces, reminding the operation personnel pay attention to avoid high temperature hazard.

**Biohazard**

This label is used to indicate that this area or the experiment cabin may be contaminated by biological reagent or potential infectious materials, certain precautions must be taken while operating relative works.



IVD Instrument: the instrument belongs to In Vitro Diagnostic equipment.



European Community Representative: indicates the authorized representative of this instrument in European.



CE Mark: indicates the instrument is in conformity with In Vitro Diagnostic Medical Devices Regulation (EU) 2017/746.



Serial Number: indicates the serial number of this instrument.



Manufacturer: indicates the manufacture of this instrument.



Caution: indicates the “caution” of this instrument.



Manufacture Date: indicates the manufacture date of this instrument.



Consult Instructions for Use: indicates the consult instructions for the use of this instrument.



Separate Collection for this Equipment: indicates that when the end-user wishes to discard this electrical and electronic equipment, it should not be discarded as unsorted waste but must be sent to separate collection facilities for recovery and recycling.



Made in China: Indicates that the instrument originated in China.

C. Symbols Used in This Manual

The following table represents the symbols used in this manual and directly refers to the safe and proper operations of the instrument. Please pay special attention to the following symbols.

Icon	Description
	<p>Warning</p> <p>Warning the operation personnel pay attention to a certain operation. Operating the Automatic Nucleic Acid Extractor in any manner unspecified in this manual may results in instrument damage or abnormal function.</p>
	<p>Reminding</p> <p>Providing important information that critical to the success operation or usage of</p>

the Automatic Nucleic Acid Extractor, including the information explained in further detail elsewhere in this manual.



Prohibit





Prohibiting the operation personnel from a certain dangerous operation. Otherwise it may results in instrument damage or abnormal function, even constitutes a personal injury hazard.

D. Conventions Used in This Manual

Convention	Meaning
Ordered list	Procedure steps must be performed follow the list order.
(Double) Click A	Click A on the application software.
Click A > B	Click B in menu A on the application software.
Press A	Press A key on the instrument system software.
<i>Italic + Bold</i>	Refers to the instructions/options of the application software.
< <i>Italic + Bold</i> >	Refers to the keys/icons of the application software.
Bold	Refers to the instructions/options of the instrument system software.
< Bold >	Refers to the keys/icons of the instrument system software.
[]	Refers to the keys on computer keyboard.
<i>Italic + Blue</i>	Indicate the reference chapter.

3. Important Operation Safety Information

Before install and use the Automatic Nucleic Acid Extractor, please read the user manual carefully and have a comprehensive understanding of the instrument.

Icon	Meaning
	<p>Warning</p> <p>Please carefully read this manual before usage. Incorrect understanding or operation may result in instrument damage, laboratory damage, operating personnel injury or inefficiency usage of the instrument.</p>
	<p>Warning</p> <p>Please pay attention to the descriptions which are marked with 'Warning', 'Reminding', 'Prohibit', and the safety symbols and labels used in this manual or on the instrument.</p>
	<p>Warning</p> <ol style="list-style-type: none"> 1. Before install and use the Automatic Nucleic Acid Extractor, please remove and reserve the transport lock within its experiment cabin. 2. Please confirm you have removed the transport lock before energizing the instrument. 3. Before moving or transporting the instrument, please install the transport lock again. <i>Otherwise XATL Co., Ltd. will not be responsible for any instrument damage.</i>
	<p>Warning</p> <ol style="list-style-type: none"> 1. Please check for the quantity and quality of the items in the package according to packing list. Report any damages or lacks to the distributor or XATL Co., Ltd. 2. After acceptance, please fill in the installation feedback table with corresponding information, and send it back to XATL Co., Ltd. for documentation and warranty. 3. Please keep the packing materials for future use, for damages as consequences of improper packaging that incurred during the transportation, XATL Co., Ltd. will not be responsible for the warranty.
	<p>Warning</p> <p>In case of any following conditions, please immediately cut off the power supply and contact the distributor or the manufacturer to ask for professional maintenance personnel for processing;</p>

- Any liquid has entered into the instrument;
- Abnormal sound or smell appears while the instrument is running;
- Instrument shell damage;
- Obvious functional changes of instrument.

**Warning**

1. Please do not open the experiment cabin door while the instrument is running.
2. Do not directly touch the heating bars while the instrument is still running, they may generate enough heat to cause serious burns.
3. Please do not force to place an unsuitable 96-wells plate into the instrument.

**Warning**

Without the authorization of **XATL Co., Ltd.**, operating personnel are not allowed to open the apparatus, replace any component or debug the instrument. Such as the need to open the instrument must be approved by the manufacturers and be performed by professional maintenance personnel, otherwise **XATL Co., Ltd.** will not be responsible for warranty.

**Warning**

The voltage required by the instrument may cause harms to human body, please cut off the power before open the instrument housing.

**Prohibit**

The instrument contains permanent magnet field. Anyone who wears cardiac pacemaker or metal prosthetic device is prohibited to operate the instrument. The permanent magnet field may affect the functions of the cardiac pacemaker and metal prosthetic device, even result in damages.

**Prohibit**

1. Never clean the instrument while it is running.
2. Never clean the instrument surface with high concentration alcohol (more than 75%) and other organic solvents.

**Prohibit**

1. Never move the instrument while it is running.
2. Never cover the instrument with cover or anything while it is still running.

Content

1. BRIEF INTRODUCTION.....	1
1.1 INTENDED APPLICATION FIELDS.....	1
1.2 BASIC PRINCIPLE	1
2. FUNCTION DESCRIPTIONS.....	2
2.1 INSTRUMENT STRUCTURE	2
2.2 FEATURES	3
2.3 TECHNICAL PARAMETERS.....	4
2.3.1 <i>General Parameters</i>	4
2.3.2 <i>Performance Parameters</i>	5
3. INSTALLATION AND TRANSPORTATION.....	7
3.1 RECEIVING INSTRUCTIONS.....	7
3.2 ENVIRONMENTAL REQUIREMENTS	7
3.3 INSTRUMENT INSTALLATION	8
3.4 RUNNING MONITORING	10
3.5 INSTRUMENT TRANSPORTATION.....	11
4. INSTRUMENT OPERATION INSTRUCTIONS.....	13
4.1 START UP.....	13
4.2 INSTRUMENT SYSTEM SOFTWARE FUNCTION	14
4.2.1 <i>Stand-by Interface</i>	15
4.2.2 <i>Experiment Selection Interface</i>	16
4.2.3 <i>Experiment Running Interface</i>	16
4.2.4 <i>Instrument Setting Interface</i>	18
4.2.5 <i>UV Lamp Disinfection Interface</i>	19
4.3 INSTRUMENT SYSTEM SOFTWARE OPERATION	19
4.3.1 <i>Run & View an Experiment</i>	20
4.3.2 <i>UV Lamp Disinfection</i>	21
4.3.3 <i>Key Tone Setting</i>	22
4.4 POWER OFF	22

5. TABLET PC OPERATION INSTRUCTIONS.....	24
5.1 APPLICATION SOFTWARE LOGIN	24
5.2 APPLICATION SOFTWARE FUNCTION	25
5.2.1 <i>Experiment Interface</i>	26
5.2.2 <i>Disinfection Interface</i>	33
5.2.3 <i>Instrument Interface</i>	35
5.2.4 <i>Setting Interface</i>	36
5.3 APPLICATION SOFTWARE OPERATION	42
5.3.1 <i>User Login, Registration</i>	42
5.3.2 <i>Connect to Instrument</i>	43
5.3.3 <i>Run Experiment</i>	43
5.3.4 <i>UV Disinfection</i>	43
6. MAINTENANCE	44
6.1 REGULAR MAINTENANCE	44
6.2 DISINFECTION TREATMENT	45
6.3 PACKAGE AND DEPOT REPAIR	46
7. TROUBLESHOOTING AND AFTER-SALE SERVICE.....	47
8. CONTACT INFORMATION.....	49
ANNEX I. LABORATORY MANUAL.....	50
ANNEX II. PRODUCT ACCESSORIES LIST.....	56

User Manual Modification Points between Versions				
SN	Modification Point	Current Version	Page	Date
1	Manual Version; Modification Time	V2.5	II	12.12.2023
2	Registered Trademark		III	
3	Label		V / VI	
4	User Manual Modification Points between Versions		This page	
5	Power supply		5	
6	Reminding		48	
7	Contact Information		49	
8	Annex II		56	
<p>Note: This modification points are only for client reference. If you need modification details, please contact <i>XATL Co., Ltd</i> after-sale service referring to "8. Contact Information".</p>				

1. Brief Introduction

1.1 Intended Application Fields

Automatic Nucleic Acid Extractor is widely used for researches in the fields of common science, genomics, CDC, food safety, forensic medicine, etc. User could simply operate the Automatic Nucleic Acid Extractor by adding samples and magnetic beads based nucleic acid extraction reagents into the 96 deep well plates, selecting or editing appropriate procedures. Through the collocation of different types of nucleic acid extraction reagents, RNA/DNA can be effectively extracted from plant or animal tissues, blood or body fluid samples and criminal materials.

1.2 Basic Principle

The Automatic Nucleic Acid Extractor is designed as a high-tech product to extract the nucleic acid through magnetic beads method. It is characterized as high degree of automation, fast extraction speed, reliable results and easy operation. By utilizing of 96 deep well plates, it is capable of simultaneously deal with 1 to 32 samples. The Automatic Nucleic Acid Extractor takes advantage of the magnetic rods that located on magnetic rod frame, automatically transfer the magnetic beads-nucleic acid mixture from one well to another, then through the movement of magnetic rods and magnetic rod covers, the instrument quickly and repeatedly stirring the reagent, evenly mix the reagent with the magnetic beads. Through the cell lysis, nucleic acid adsorption, washing and elution processes, the instrument will complete the extraction of nucleic acids and obtain highly purified nucleic acids, as shown in the figure 1-1.

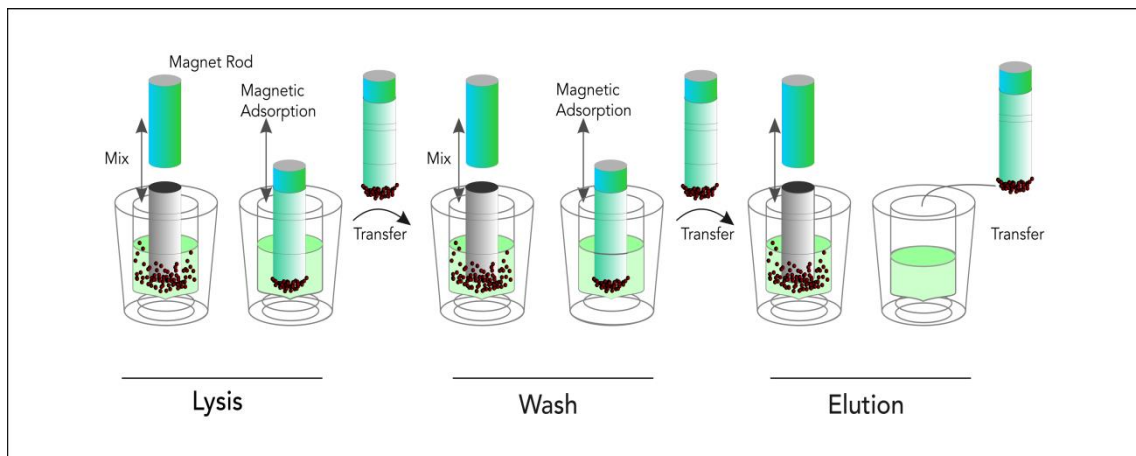

Figure 1-1 Principle Steps of Magnetic Beads Processing

2. Function Descriptions

2.1 Instrument Structure

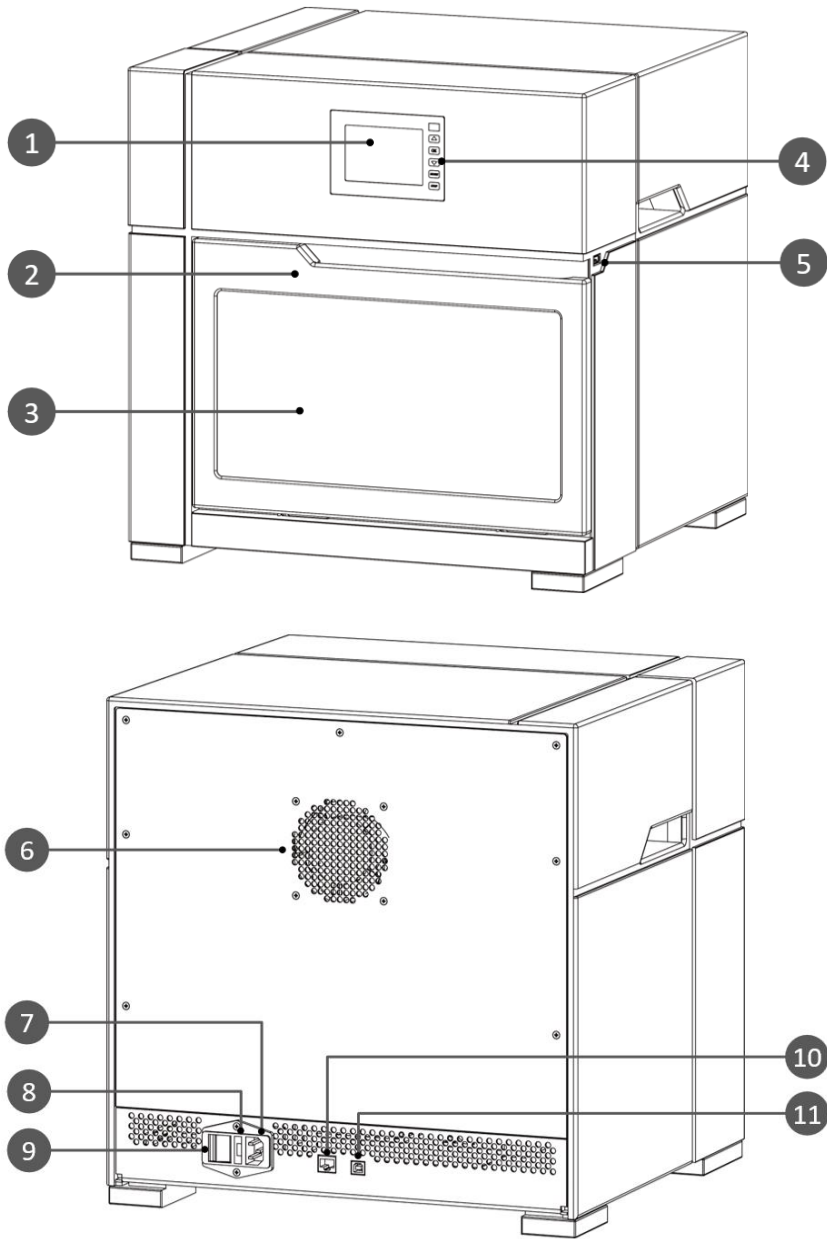

Figure 2-1 Nucleic Acid Extractor

- | | | |
|--------------------------|--------------------------|----------------------------|
| 1. Instrument LCD Screen | 2. Experiment Cabin Door | 3. Experiment Cabin Window |
| 4. Keypads | 5. USB Port | 6. Heat Emission Hole |
| 7. Power Outlet | 8. Fuse Tube Socket | 9. Power Switch |
| 10. Ethernet Port | 11. Reserved PC Port | |

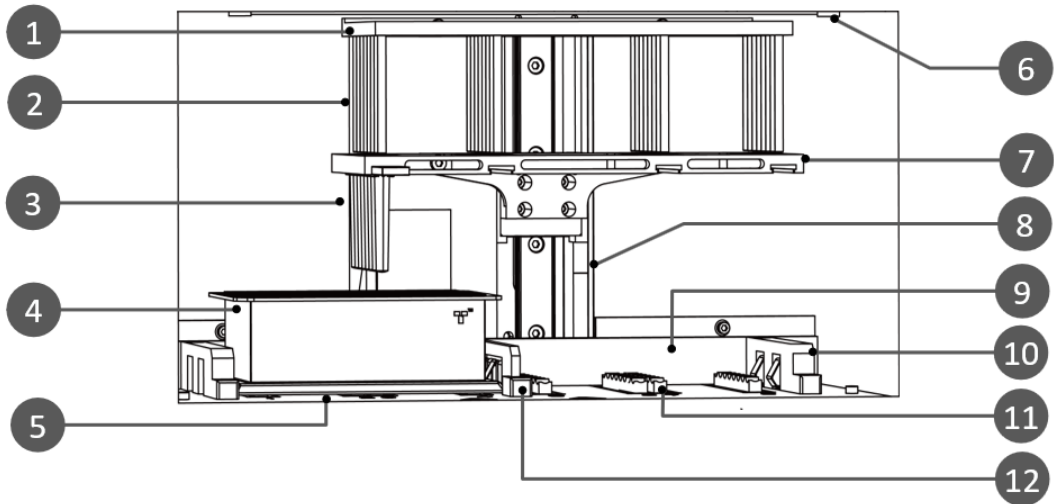

Figure 2-2 Experiment Cabin

- | | | |
|-----------------------------|------------------|----------------------------------|
| 1. Magnetic Rod Frame | 2. Magnetic Rods | 3. Magnetic Rod Covers |
| 4. 96 Deep Well Plate | 5. Base Plate | 6. UV Lamp |
| 7. Magnetic Rod Cover Frame | 8. Motion Device | 9. Back Positioning Bar |
| 10. Side Positioning Bar | 11. Heating Bar | 12. Intermediate Positioning Bar |

2.2 Features

- **Screen Operation:** The instrument is equipped with a 3.5 inch LCD screen. It is capable of independently operating and monitoring the real-time running status.
- **Precision Control:** Built-in engineering computer endows the system the capability of operating independently without PC; Providing highly stable automatic control system; Saving more space and energy at the same time.
- **User-defined Temperature Control:** User could easily define the temperature for lysis and elution by themselves
- **Rapid Extraction:** Short operation time, requires only 30 to 60 minutes (depends on reagents) for single time operation. High throughput, capable of extracting 32 sample simultaneously. 15 or 48 throughput version is able to customize as needed.
- **High Extraction Efficiency:** The extraction protocol can be optimized according to the reagents for more precise incubation time. Truly realize the high efficiency extraction. The high purity extracted DNA/RNA can be directly used for PCR and RT-PCR.

- **Stability and Reliability:** Automatic operation system could avoid the deviations and errors that caused by manual operation, ensuring the stability and reliability of experimental results.
- **Self-cleaning:** With built-in UV lamp disinfect function, it is capable of performing regularly disinfection.
- **Contamination Control:** By means of precision motion control, self-cleaning and using disposable material, the inter-well and inter-batch contamination are strictly controlled to prevent cross-contamination.
- **Safety Reliability:** Automatic lock program ensures the operation safety. The closed experiment cabin and the utilization of disposable experimental materials minimize the contact between the operation personnel and the reagents. Intelligent operation system protects the operation personnel from the hazards of harmful substances.
- **Reagent:** Open reagent.
- **Throughput Replaceable:** The instrument is able to be customized with 15, 32 and 48 throughputs.

2.3 Technical Parameters

2.3.1 General Parameters

1) Instrument specifications

Size: 440mm (L) × 435mm (W) × 445mm (H)

Weight: 31.5kg

2) Package specifications

Size: 670mm (L) × 580mm (W) × 580mm (H)

Weight: 39 kg

3) Operating environment

The instrument is intended for indoor use only. Environment temperature should be between 10°C and 30°C. Relative humidity should be less than or equal to 80%. The atmospheric pressure of the operating environment should be between 56.0 kPa and 106.0 kPa, the elevation should be less than 4000 meters.

4) Storage and transport environment

Temperature: -20°C and 55°C;

Relative humidity: 0~93%RH;

Atmosphere pressure: 26.4kPa~106.0kPa.

5) Power supply

Power voltage: AC 100V ~ 240V

Power supply frequency: 50/60 Hz

Rated power: 600W, the rating of insulation of external circuits can only be connected to IEC/EN 60950 approved peripheral device.

2.3.2 Performance Parameters

1) Processing Volume

30 μ L to 1000 μ L (32 throughputs, standard 96 deep well plate).

2) Capacity

1 to 32 samples (32 magnetic rods, 96 deep well plate and standard extraction reagent. 15 and 48 throughputs are able to be customized).

3) Collection Efficiency of Magnetic Beads

>95% (Use the 96 deep well plate and magnetic rod covers provided by XATL Co., Ltd.; 1 μ m magnetic beads; Recycle 1 time in 6mol/l guanidine hydrochloride; Recycle 2 times in neutral washing liquid).

4) Inter-well Purification Accuracy

CV < 3% (For identical concentration samples that are extracted in identical process).

5) Magnetic Rods

The magnetic rod frame is for 32 magnetic rods.

6) Mixing Mode

Optional multi-modes and multi-gears for mixing.

7) Heating Temperature

Optional heating mode: lysis heating (from room temperature to 120 $^{\circ}$ C) and elution heating (from room temperature to 120 $^{\circ}$ C).

8) Program Storage

The instrument firmware system can store up to 15 experimental programs.

9) Power Failure Protection

The instrument could continue the unfinished experiment, when it is restarted in case the unexpected power failure has occurred.

10) Disinfection

The instrument is equipped with an UV lamp within its experiment cabin. The disinfection time can be manually or automatically controlled.

11) Plates Forms

Dedicated plates, 6-strip tubes and 96 deep well plates are available according to the different throughputs.

3. Installation and Transportation

3.1 Receiving Instructions

The instrument and its accessories are well packed in a package. Before opening the package, please move it to a suitable workplace. In order to prevent the instrument from condensate water, please do not open the package until it reaches room temperature. Then open the package and place the instrument and its accessories on a horizontal platform. Check for the quantity and quality of the items in the package according to packing list. Report any damages or lacks to the distributor or the manufacturer.

After opening the package, please keep the original package and packing material for future transportation. The original package and packing materials are designed to decrease the possibility of instrument damage and ensure the instrument safety during transportation. Use other package or packing materials violates the warranty. For the damages as consequences of improper packaging that incurred during transportation **XATL Co., Ltd.** will not be responsible for the warranty.

 **Warning:** please do not remove any screws or other parts, unless it is specifically mentioned in this manual. This kind of behavior violates the warranty and may cause the instrument out of alignment.

 **Warning:** the net weight of Automatic Nucleic Acid Extractor is about 31.5 kg, which may be too heavy for one person. In order to avoid instrument damage, it is suggested to carefully carry the instrument by two people with safe guard.

3.2 Environmental Requirements

The installation and use of Automatic Nucleic Acid Extractor should be performed indoor. The room should be well ventilated and please avoid dust, vibration, strong magnetic field, direct sunlight, UV radiation, air flow, high humidity and significantly temperature changes.

Place the instrument on common laboratory table which is away from heating furnace, stoves and other heat sources. Please do not place the instrument on soft cushion, the instrument base may sink into the cushion and block up the air vent beneath.

The specific environmental requirements are as follow:

- 1) The working area should be flat, dry and clean, which should avoid shaking and has enough room for accessories, such as cables, reagent bottles, etc.
- 2) Leave enough space on each side of the instrument (25cm at least).
- 3) The environment should be clean and without corrosive gas, smog and dust.
- 4) Never run the instrument in an explosive environment.
- 5) Never run the instrument in environment with potential dangerous liquid or gas.
- 6) Ensure the environment temperature range is between 10°C and 30°C.
- 7) Ensure the environment relative humidity is between 0% and 80%.
- 8) The instrument should be installed at a safe place which is easy to plug the power cord.
- 9) The instrument should be away from the places where people usually move around.
- 10) Voltage requirement: AC 100V~240V, 50Hz / 60Hz \pm 1Hz.
- 11) Input power: 600W. An UPS power supply is suggested.





3.3 Instrument Installation

Automatic Nucleic Acid Extractor belongs to laboratory equipment, whose installation should follow the instructions as below:

- 1) Confirm the locating place first and then place the instrument on the laboratory table. Leave enough space on each side of the instrument (25cm at least).
- 2) Open the experiment cabin door after placing the instrument. Remove and reserve the transport lock according to the labeled warning instruction, as shown in the figure 3-1. In order to protect the instrument from damages, please fix the transport lock before moving or transporting it again (please refer to '[3.5 Instrument Transportation](#)'). Please confirm the transport lock could be removed normally.
- 3) Close the experiment cabin door.
- 4) Plug the instrument power cord and do not power on the instrument.



Warning: the power cord must be reliable grounded. Please confirm that the power voltage and frequency match the requirements of the instrument.

-  **Warning:** under normal circumstances, please use the provided power cord. If the original power cord becomes cracked, frayed, broken or otherwise damaged, please substitute it with the equivalent one.
-  **Warning:** do not put anything on the power cord and keep it away from places where people move around.
-  **Warning:** please hold the plug when you plug the power cord and ensure it is perfectly inserted into the socket, do not pull the power cord to unplug.
-  **Warning:** the rating of insulation of external circuits can only be connected to IEC/EN 60950 approved peripheral device.

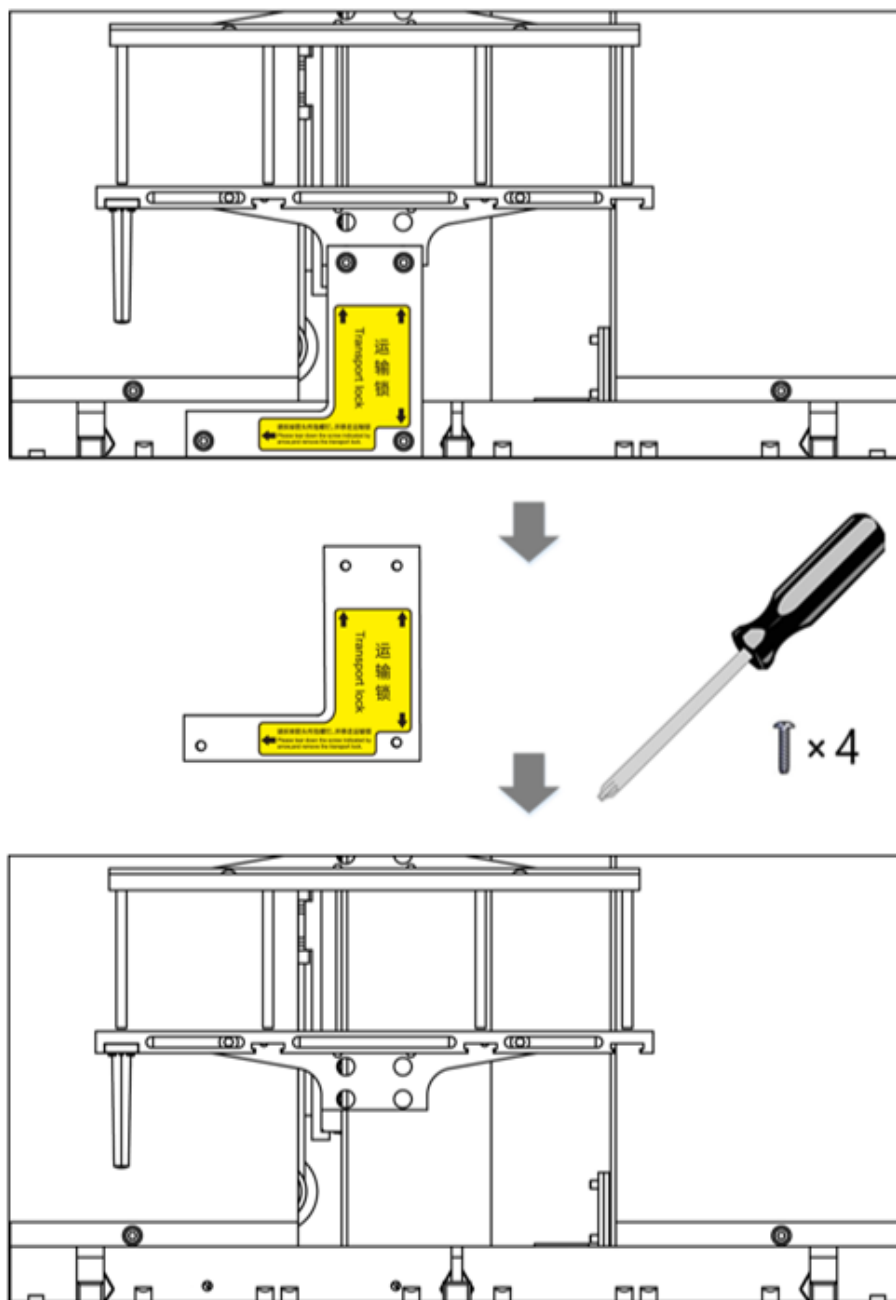



Figure 3-1 Transport Lock

3.4 Running Monitoring

The instrument owns self-testing function. User could let it self-test before running to ensure the normal operation. Specific operation is as follows:

- 1) Connect the power cord and switch on the power switch at the back side of the instrument.
- 2) The instrument will start self-testing after power on and the self-test result includes the instrument version, the power supply state, electric system state and the motor positions will be displayed on the screen.

- 3) The instrument will be on standby state after the self-test.
- 4) In order to observe whether the instrument could normally function, it is suggested to run the 'Demo' program before running your experimental program.

 **Warning:** for first time utilization, please ensure the transport lock is removed before connecting the power supply and usage.

 **Warning:** please close the experiment cabin door while the instrument is self-testing. Do not frequently open and close the experiment cabin door.

 **Warning:** restart the instrument in case the self-test is failed or the LCD screen doesn't work properly. Please contact the distributor or the manufacture if the self-test failed again. Please do not flap or shake the instrument.

3.5 Instrument Transportation

In order to protect the instrument from damage, please fix the transport lock before moving or transporting it again. Please strictly follow the transporting instructions as below:

- 1) Cut off the power supply and open the experiment cabin door.
- 2) Fix the transport lock. Hold the magnetic rod cover frame or magnetic rod frame, and move the frame to the left most end where the locking position is.
- 3) Fix the transport lock at the location where it should be. Specific operation is shown in the figure 3-2.
- 4) Close the experiment cabin door.
- 5) Steadily place the instrument into the package, then close and seal the package.

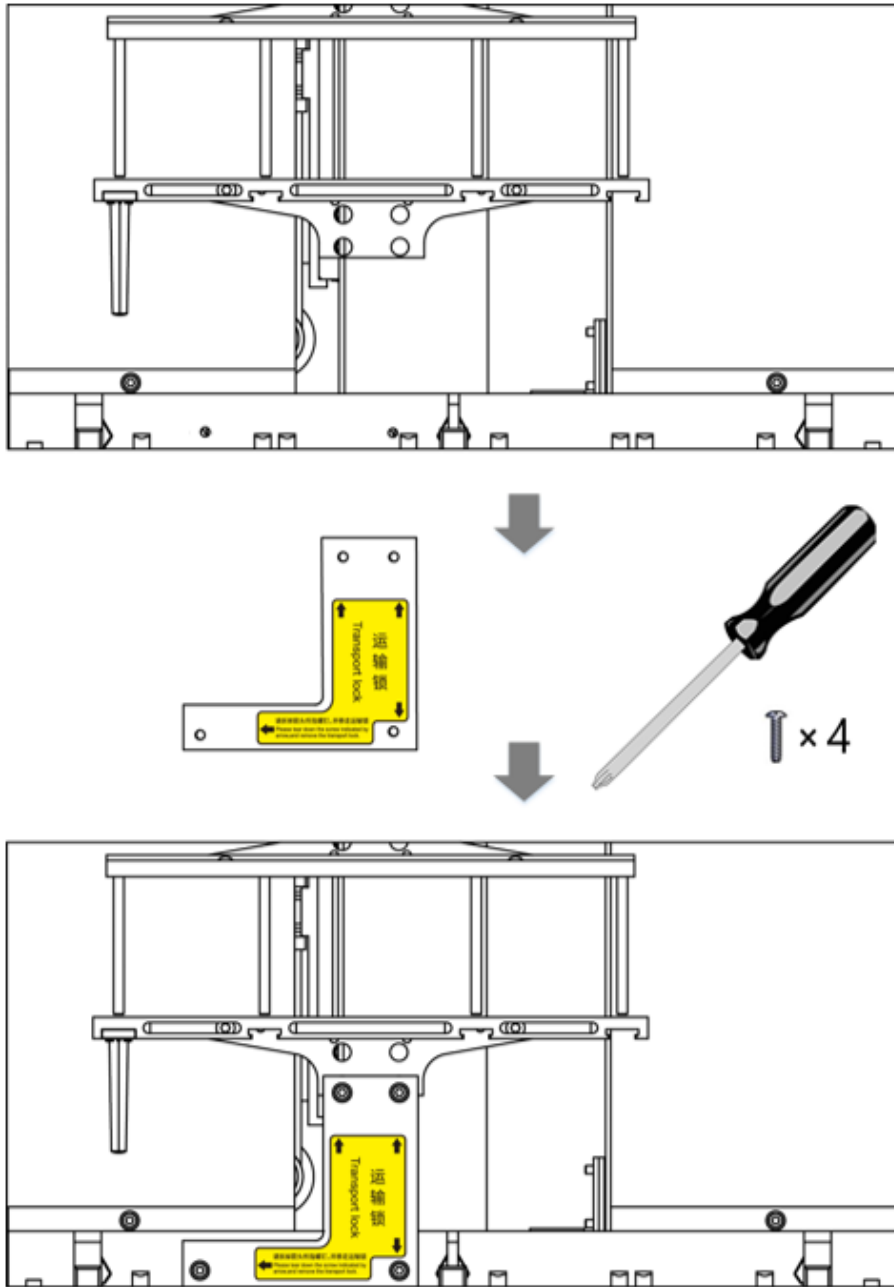

Figure 3-2 Fix Transport Lock

4. Instrument Operation Instructions

This section introduces the function of instrument system software and its operational process. Please operate the instrument in accordance with the instructions and processes provided herein. Incorrect operation may cause instrument damage or abnormal running phenomena.

4.1 Start up

Turn on the power switch at the back side of the instrument, the buzzer will beep twice. After this, the instrument will begin to start up, whose LCD screen will light up and automatically enter the self-test interface for self-test and initialization, as shown in the figure 4-1.

The instrument self-test and initialization includes firmware version querying, power supply testing, temperature control testing, motion device testing, switch testing, communication device testing and other external connection ports testing. After the initialization, the motion device of the instrument will be at zero position.



Figure 4-1 Self-test Interface

⚠ Warning: please ensure the transport lock was removed before first time usage, then connect the power cord and turn on the power switch. If the transport lock was not removed, please refer to [3.3 Instrument Installation -- 2.](#)

- ⚠ **Reminding:** before connecting the power supply, please ensure the consistent of the instrument required voltage and the power supply voltage.
- ⚠ **Reminding:** the instrument required voltage is marked on the name plate located at lower left corner on the back side of the instrument.
- ⚠ **Warning:** do not connect the power supply with a non-grounded socket or unmatched voltage.
- 🚫 **Prohibit:** never touch the plug, the power cord or the power switch with wet hands, in order to avoid the instrument damage or operation personnel injure.

4.2 Instrument System Software Function

The instrument will automatically enter the stand-by interface after initialization, as shown in the figure 4-2.

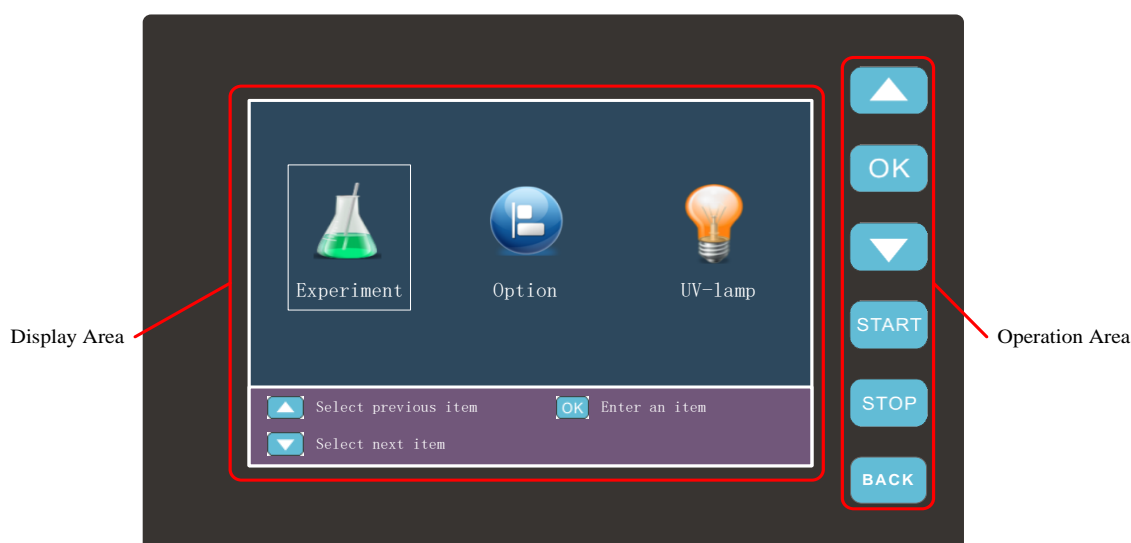

Figure 4-2 Instrument System Software

The left side display area is consisted of two parts: the upper part is function display area, the lower part is prompt display area, the corresponding operation prompts are displayed in this area.

The right side operation area contains several keypads, user could press corresponding keypad to operate the function in accordance with the operation prompts.

- ▲ Select previous function or experimental program; Select previous step to start.

- OK** Enter the selected item; Confirm the setting; View an experimental program.
- ▼** Select next function or experimental program; Select next step to start.
- START** Start an experimental program from the selected step; Start a function
- STOP** Pause or stop an experimental program or a function.
- BACK** Continue a paused experimental program; Return to desktop; Cancel a selected function.

4.2.1 Stand-by Interface

The instrument system software will automatically enter the standby interface after self-check and initialization. The standby interface consists of two parts: the function display area and the prompt display area, as shown in figure 4-3.

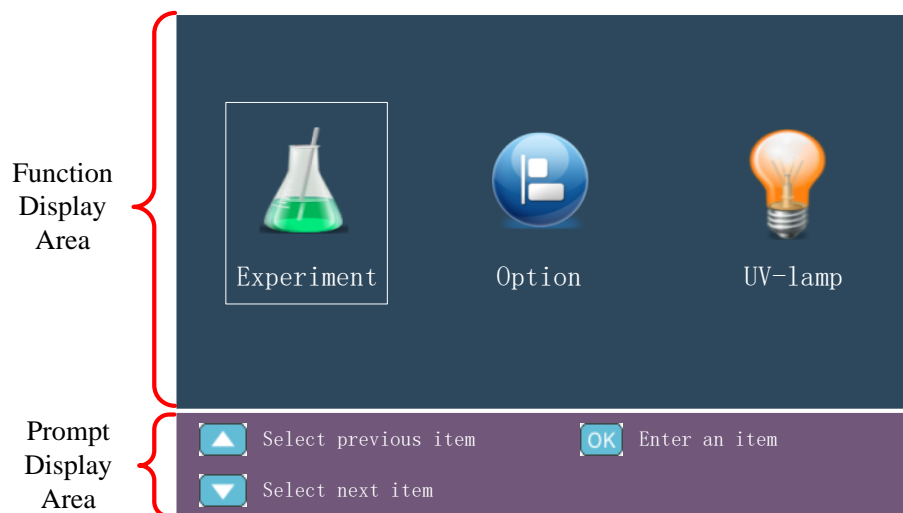









Figure 4-3 Instrument System Software - Standby Interface



1. **Function display area:** three icons are displayed on the stand-by interface.
 - ▶ <  **Experiment** > icon refers to experimental program, select this icon to enter the experiment interface, where user could select and run a certain experimental program as needed.
 - ▶ <  **Option** > icon refers to instrument partial function setting. Such as the disinfection time setting and the key tone setting.
 - ▶ <  **UV-Lamp** > icon refers to UV lamp disinfection. User could manually control the

disinfection or let the instrument to automatically control the disinfection.

2. **Prompt display area:** the corresponding operation prompts are displayed in this area.

- ▶ According to the operation prompts on the stand-by interface, as shown in the figure 4-3. The <  **Experiment** > icon is selected, User could press  to enter the experiment interface, or press  and  to select another icon.

4.2.2 Experiment Selection Interface

The experiment selection interface is shown in the figure 4-4. The experiment program with the white background is selected. User could press  or  to select other experimental program and then press  to open the selected experiment program. The instrument is capable of automatically recording the latest experiment program, and the maximum experiment program storage count of is 15.





Experiment		
No.	Name	User
1	Demo	guest
2	Virus RNA	guest
3	Whole Blood DNA	guest
4	Virus DNA	guest
5	Isz1z	guest
 Select previous experiment  View an experiment  Select next experiment		

Figure 4-4 Instrument System Software - Experiment Selection Interface

4.2.3 Experiment Running Interface

After selecting a certain experimental program on the experiment selection interface, user could press  to enter the experiment running interface, as shown in the figure 4-5.

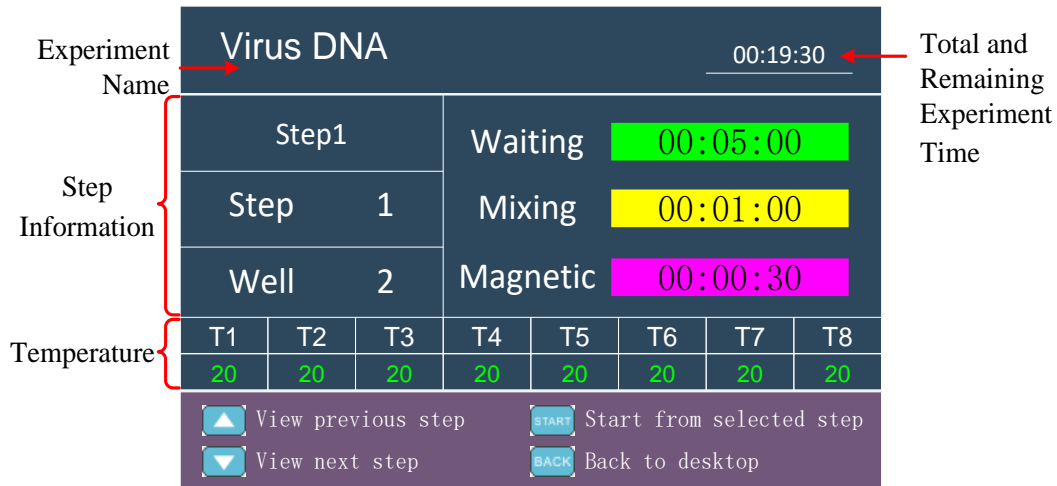

Figure 4-5 Instrument System Software - Experiment Running Interface

- ▶ The selected experiment program will stand-by for running and the detailed information (Experiment name; Step information; Temperature; Total and remaining experiment time) of the selected experiment program will be displayed. And the step information including: step name, step number, well position, waiting time, mixing time and magnetic adsorbing time, as shown in figure 4-6.

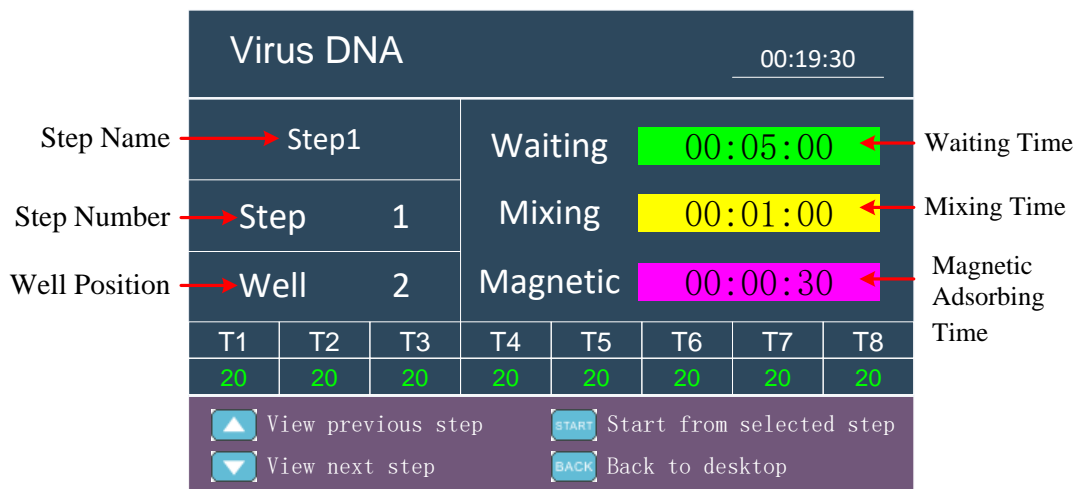

Figure 4-6 Experiment Running Interface - Step Information

- ▶ Press **START** to start running the selected experiment program.
- ▶ Press **STOP** to pause the experiment and there will be a prompt pop up reminding user that **'Press back to continue running the experiment and press stop to stop running the experiment'** as shown in the figure 4-7. While the experiment is running, the corresponding time of the current step will blink and enter the countdown mode.

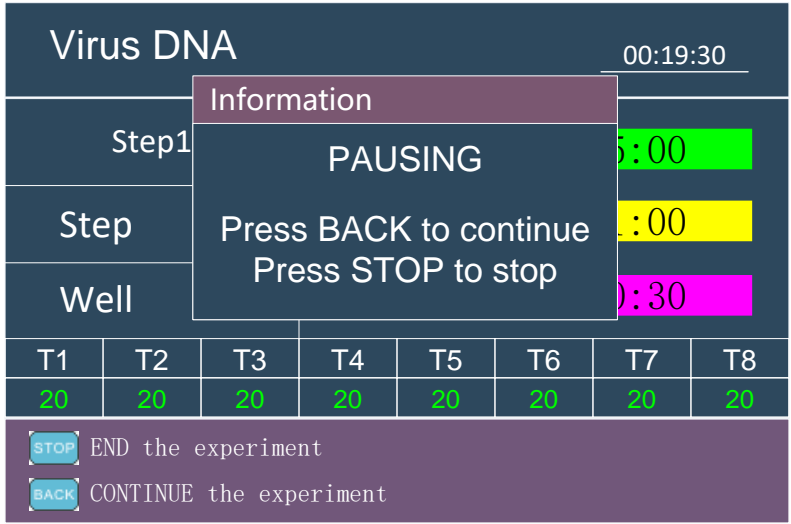

Figure 4-7 Experiment Running Interface - Pause Prompt

⚠ Reminding: do not open experiment cabin door while the instrument is running. The experiment program will be suspended until the experiment cabin door is closed again.

4.2.4 Instrument Setting Interface

User could press or to select the icon on the standby interface, and then press to enter the instrument setting interface, as shown in figure 4-8.

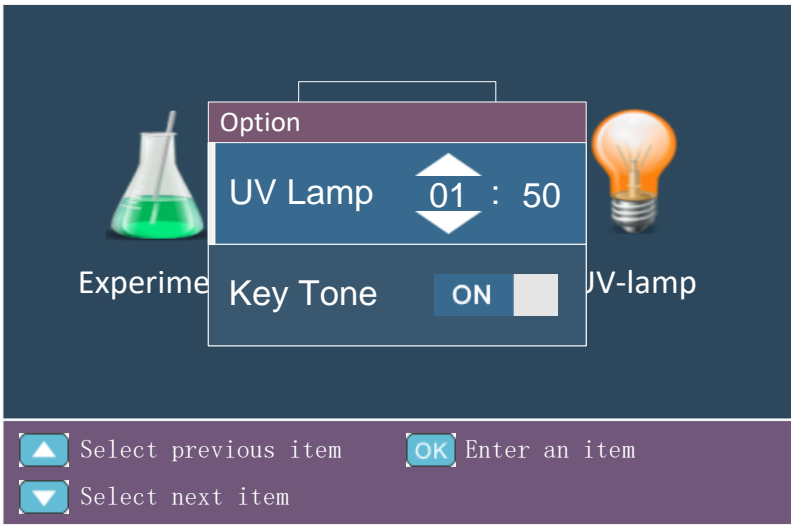





Figure 4-8 Instrument Setting Interface

- ▶ The '**UV Lamp**' refers to the UV lamp disinfection time setting.
- ▶ The '**Key Tone**' refers to whether to turn on the beep when user press the keypads.

4.2.5 UV Lamp Disinfection Interface

User could press  or  to select the  **UV-Lamp** > icon on the standby interface, and then press  to enter the UV lamp disinfection interface, as shown in figure 4-9.

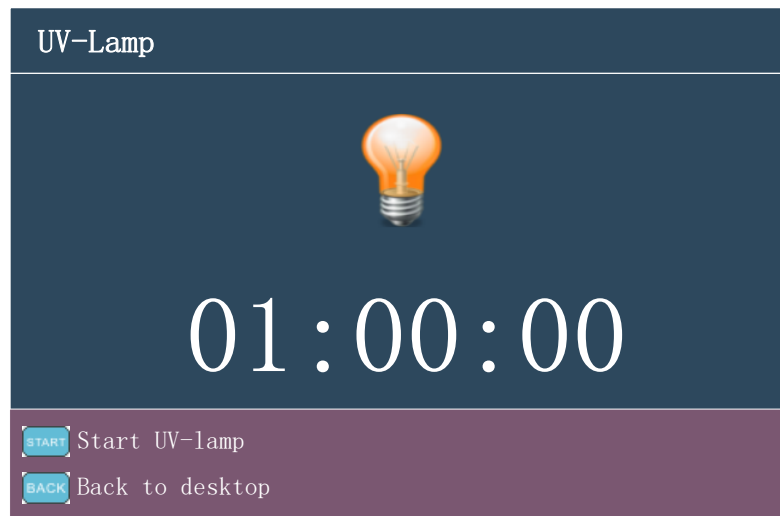







Figure 4-9 UV Lamp Disinfection Interface

- ▶ Press  to turn on the UV lamp.
- ▶ Press  to turn off the UV lamp.
- ▶ Press  to turn off the UV lamp and return to the stand-by interface.

4.3 Instrument System Software Operation

This section introduces how to use the keypads to directly operate the instrument firmware system and view the instrument files.

4.3.1 Run & View an Experiment

1. Connect the power cord and turn on the instrument. The instrument system software will automatically enter the stand-by interface after self-check and initialization.
2. Press  or  to select the <  **Experiment** > icon on the stand-by interface, as shown in figure 4-10.

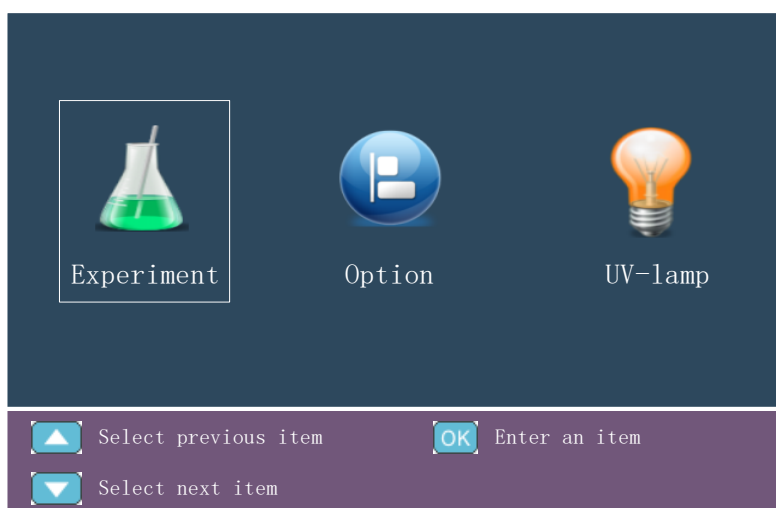













Figure 4-10. Select <  **Experiment** > Icon

3. Press  after selecting the <  **Experiment** > icon to enter the experiment selection interface, in order to select an experiment program for running, as shown in the figure 4-4.
4. Press  or  to select a certain experiment program. Press  to enter the experiment running interface, as shown in the figure 4-5 and the figure 4-6.
5. Check the step name, step number, well position, waiting time, mixing time, magnetic adsorbing time by pressing  or .
6. Press  to start running the experiment program from the current displayed step.
7. Press  to pause the running experiment program, press  again to stop the paused experiment program or press  to continue running the paused experiment program. The magnetic rod cover frame and magnetic rod frame will automatically move back to original position if the running experiment program is stopped.

4.3.2 UV Lamp Disinfection

1. Press  or  to select the <  **UV-Lamp** > icon on the stand-by interface, as shown in the figure 4-11.

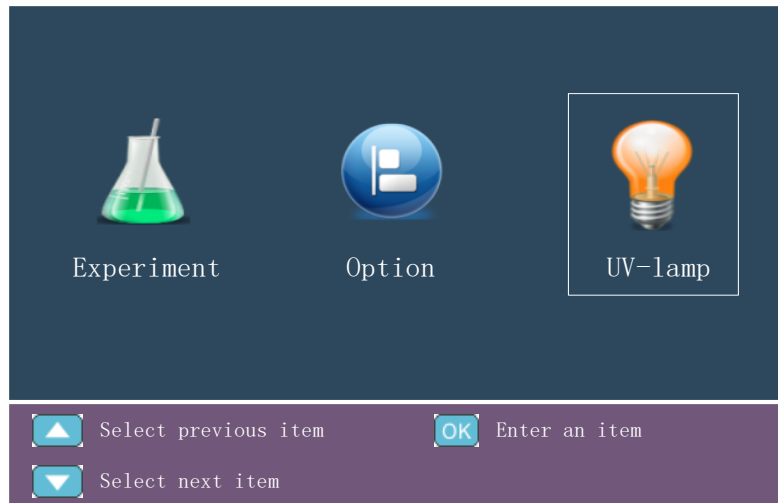



























Figure 4-11. Select <  **UV-Lamp** > Icon

2. Press  to enter the UV lamp disinfection interface, as shown in the figure 4-9.
3. Press  to turn on the UV lamp for disinfection. The default disinfection time is 1h, the UV lamp will automatically turn off when time is out. User could also press  to manually stop the UV lamp disinfection.
4. Press  in case you want to turn off the UV lamp while the instrument is still disinfecting and return to stand-by interface.
5. User could manually set the UV disinfection time, which should be between 1 minute and 12 hours. Please refer to the detail operation instructions as follow:
 - ▶ Press  or  to select the <  **Option** > icon. Then press  to enter the instrument setting interface as shown in the figure 4-8.
 - ▶ Press  or  to select '**UV Lamp**'.
 - ▶ Press  to select hour, and set the hour by pressing  or .
 - ▶ Press  to select minute, and set the minute by pressing  or .
 - ▶ Press  to confirm and save the disinfection time setting.

4.3.3 Key Tone Setting

User could decide whether to turn on the key tone when press any keypad, the specific operation instructions are as follow:

- 1) Press  or  to select the <  **Option** > icon. Then press  to enter the instrument setting interface as shown in the figure 4-8.
- 2) Select '**Key Tone**' by pressing  or .
- 3) Press  to decide whether to turn on the key tone.
- 4) Press  to return to save the current setting and return to the main interface.

 **Reminding:** user could only choose whether to turn on the key tone. It is unable to set the level and style of the key tone.

4.4 Power off

The power switch is located at the back side of the instrument, user could switch the power switch to the 'O' position to turn off the power switch.

 **Reminding:**

1. In case the instrument is in process of running and without any signs of malfunction or accident, please do not cut off the power supply to avoid affecting the running experiment.
2. In case the instrument is in process of running and without any signs of malfunction or accident, please do not cut off the power supply to avoid affecting the running experiment.
3. Please do not frequently switch the power switch during the usage of instrument.
4. Please shut off the instrument when you finish the daily experimental work.
5. Please immediately stop the experimental program and shut off the instrument in case there is any accident occurs, such as the liquid spill in the experiment cabin or the magnetic rod covers are not inserted.
6. Please unplug the power cord if the instrument will not be used for a long time.

 **Warning:**

- a. Please first shut off the instrument and unplug its power cord, in case you want to move the instrument.
- b. Please immediately cut off the power supply in case of electric leakage, and stop using the instrument.
- c. Please hold the plug when you plug the power cord and make sure the plug is perfectly inserted into the socket, do not pull the power cord to pull out the plug.

5. Tablet PC Operation Instructions

User can install the application software **“Extraction System”** on the tablet PC to operate the automatic nucleic acid extractor. This section introduces the function of the application software and its operation process. Please operate the instrument in accordance with the instructions and processes provided herein. Incorrect operation may cause instrument damage or abnormal running phenomena.

5.1 Application Software Login

Click <  **Extraction System** > on the tablet PC, the application software will automatically enter login interface, where user can enter their user name and password for login or register as a new user, as shown in figure 5-1.

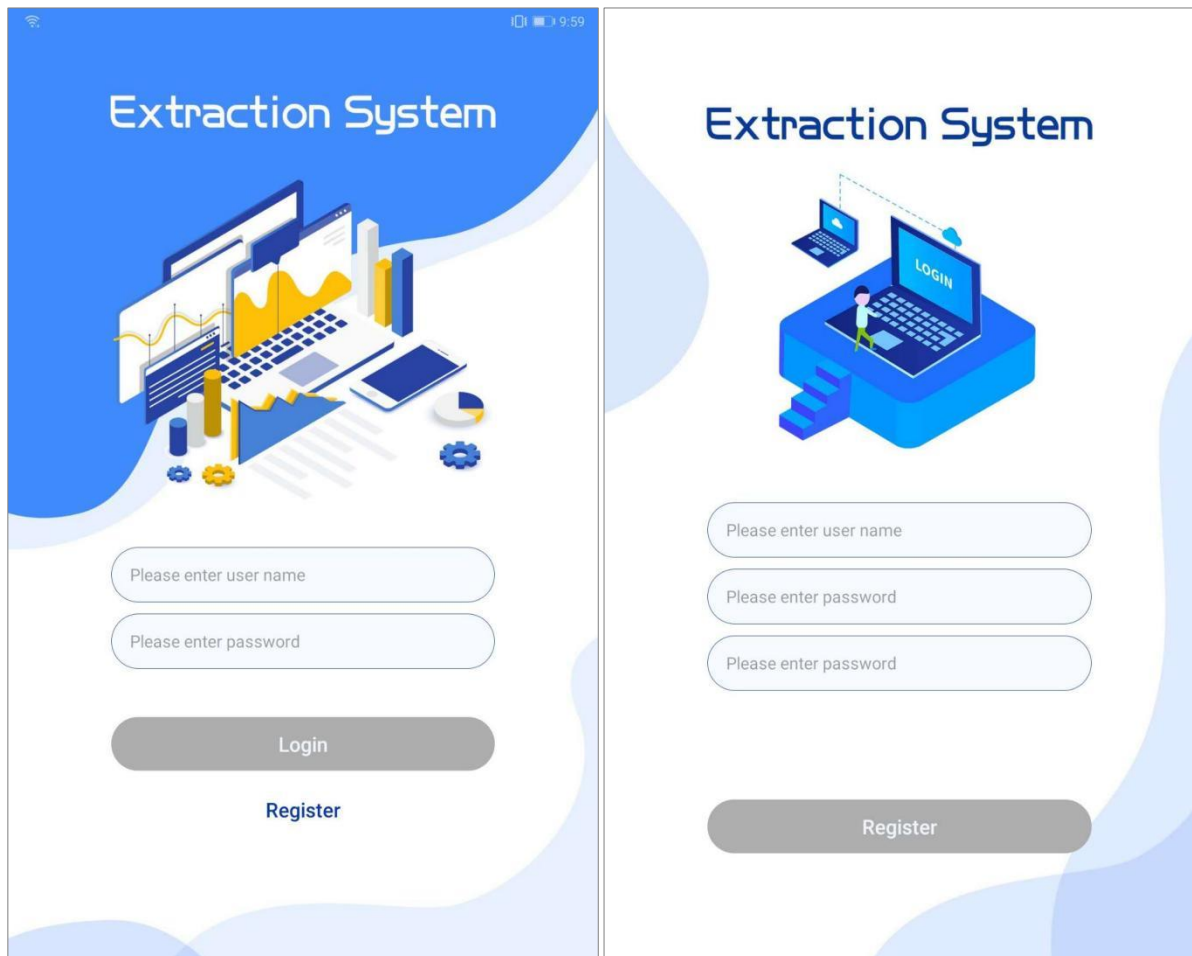

Figure 5-1. Application Software -Login Interface

5.2 Application Software Function

After login, the application software will enter the main interface, as shown in figure 5-2.

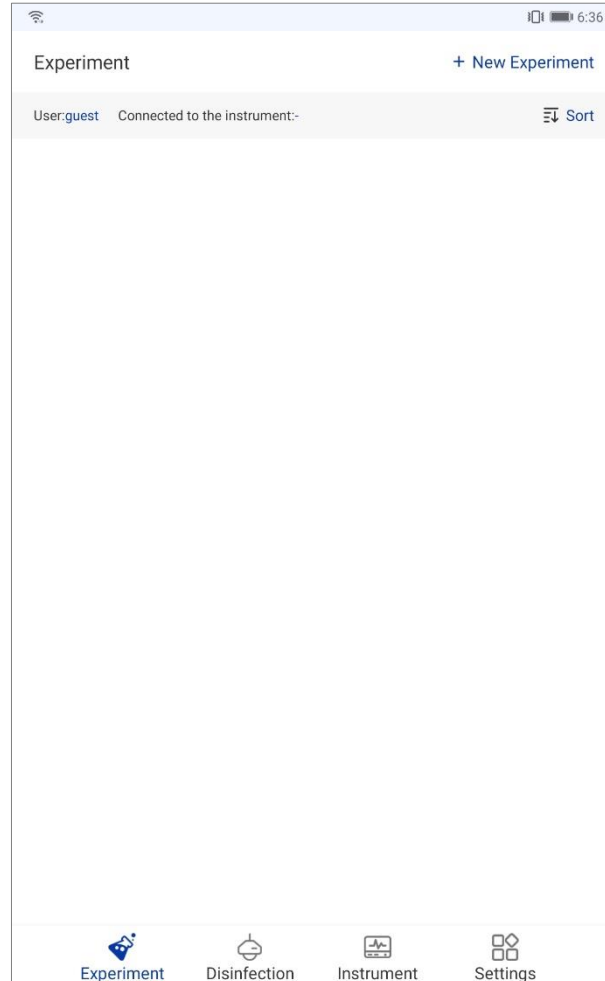











Figure 5-2. Application Software -Main Interface

The current user account is shown on the top of the main interface, as well as the instrument to which the application software is connected. And the bottom of the main interface includes four function tabs:



1. **Experiment Tab:** Click <  **Experiment** > and the icon will change into <  **Experiment** >, the main interface will automatically switch to the Experiment interface, where user can add, delete, edit and run/stop experiment.
2. **Disinfection Tab:** Click <  **Disinfection** > and the icon will change into <  **Disinfection** >, and the main interface will automatically switch to the Disinfection interface, where user can run/stop UV disinfection towards the instrument and set disinfection time.
3. **Instrument Tab:** Click <  **Instrument** > and the icon will change into <  **Instrument** >

Instrument >, and the main interface will automatically switch to the Instrument interface, where user can view instrument status and current experiment list.

- 4. **Settings Tab:** Click <  **Settings** > and the icon will change into <  **Settings** >, and the main interface will automatically switch to the Settings interface, where user can set general parameters for the instrument.

 **Reminding:** experiment tab is selected on the main interface by default, therefore the application software displays the Experiment interface by default, as shown in figure 5-2.

5.2.1 Experiment Interface

Click <  **Experiment** > and the icon will change into <  **Experiment** >, the main interface will automatically switch to the Experiment interface, where user can add, delete, edit and run/stop experiment, as shown in figure 5-3.

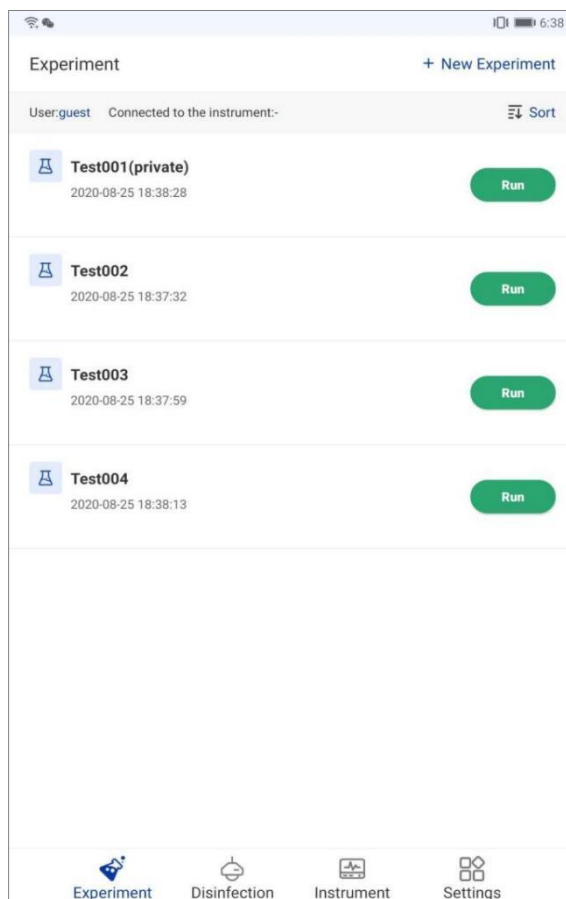



Figure 5-3. Application Software - Experiment Interface

Experiment Interface Description

- 1. New Experiment:** click < + *New Experiment* > in the upper right corner of the experiment interface, the New experiment interface will pop up automatically, as shown in figure 5-4.
 - ▶ **Experiment Name:** user can enter the name of the new experiment.
 - ▶ **Select Template:** the application software provides several experiment templates, user can select experiment template according to the specific experiment requirements.
 - ▶ **Experiment Information:** user can enter experiment information as remarks.
 - ▶ **Private Experiment:** user can click the checkbox of *Private Experiment* to disallow other user from seeing information and parameters of the current experiment.

🚨 **Reminding:** after creating a new experiment, user can click < *Next Step* > to edit the experiment. User can also edit experiment by selecting a test on the Experiment interface.
- 2. Sort:** click <  *Sort* > in the upper right corner of the experiment interface to sort experiment orders by name, time or encryption.
- 3. Synchronize to instrument:** long-press any experiment on the experiment interface and click < *Synchronize to instrument* > to synchronize the current experiment from the application software to the instrument system, as shown in figure 5-4.

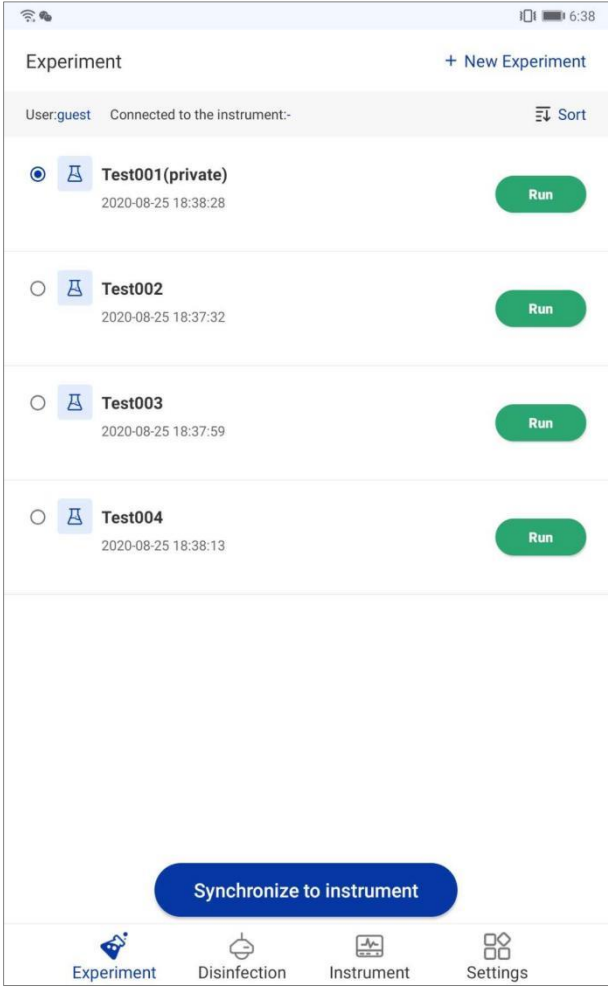

Figure 5-4. Experiment Interface - Synchronize to Instrument

- 4. **Run Test:** select any experiment on the experiment interface and click < **Run** > to enter the Experiment running interface, as shown in figure 5-5.

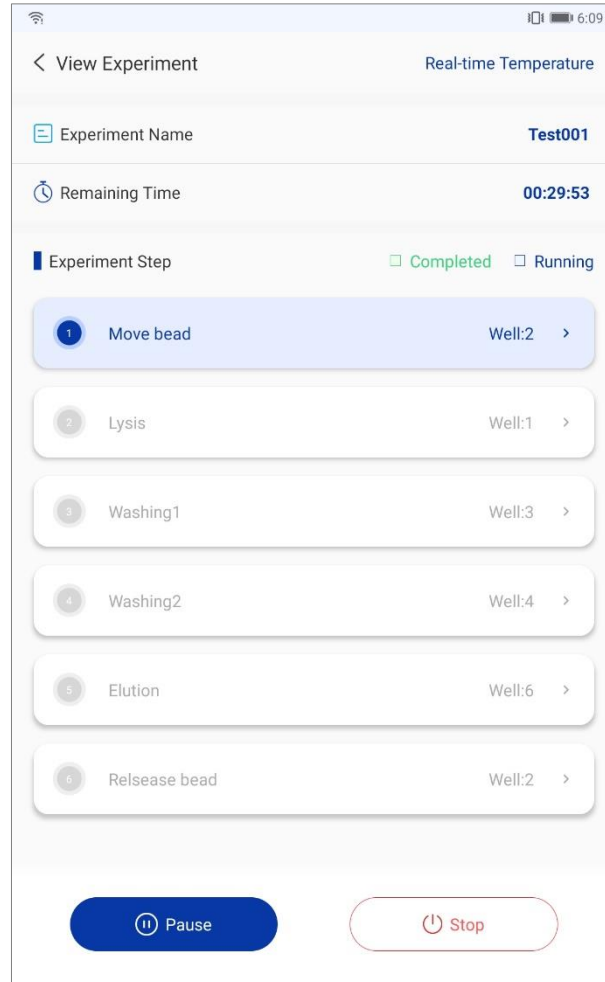

Figure 5-5. Experiment Interface - Run Experiment

- ▶ User can view current experiment name and steps.
 - ▶ Click < **Run** > to run the current experiment, or click < **Stop** > to stop the currently running experiment.
 - ▶ User can view real-time running progress, remaining time and real-time temperature of the current experiment.
5. **Delete Test:** select any experiment on the experiment interface and slide it to the left, user can click < **Delete** > to delete current selected experiment, as shown in figure 5-6.

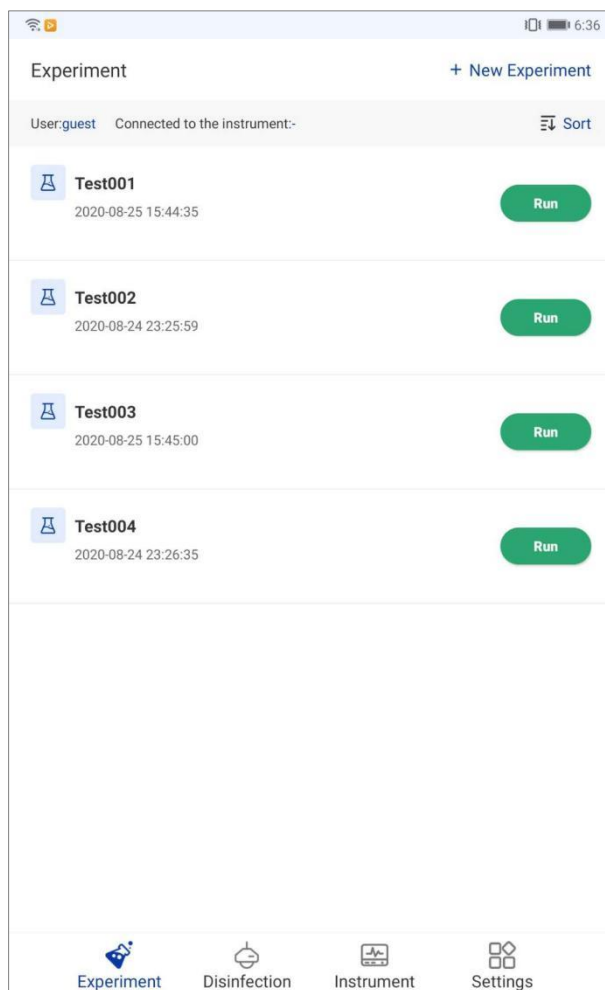

Figure 5-6. Experiment Interface - Delete/Edit Experiment

- 6. **Edit Experiment:** select any experiment on the experiment interface and slide it to the left, click < **Edit** > to edit current selected test experiment, as shown in figure 5-6.
 - ▶ First, user can edit experiment name and experiment information, as shown in figure 5-6a.

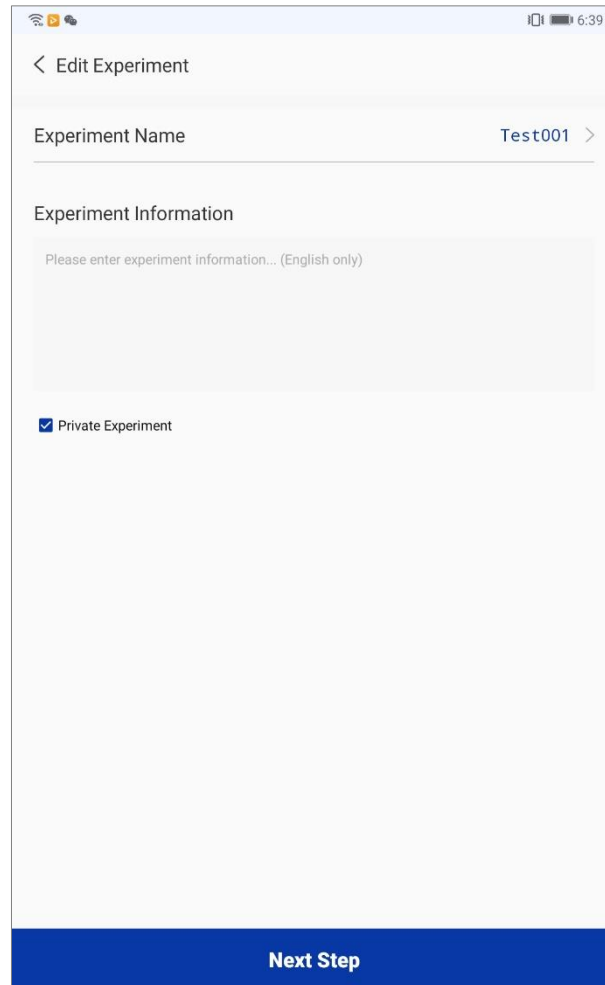





Figure 5-6a. Experiment Interface - Edit Experiment Name and Information

- ▶ User can click < **Next Step** > to continue edit the experiment steps and parameters, as shown in figure 5-7.
- **Add Step**: click <  **Add Step** > in the lower left corner of the interface to add a test step.
- **Step Order**: select any step in the step list, long-press it to drag and rearrange order.
- **Delete Step**: click <  **Delete** > inside any step card to delete it.
- **Edit Step**: click <  **Edit** > inside any step card to edit the step parameters, as shown in figure 5-8.

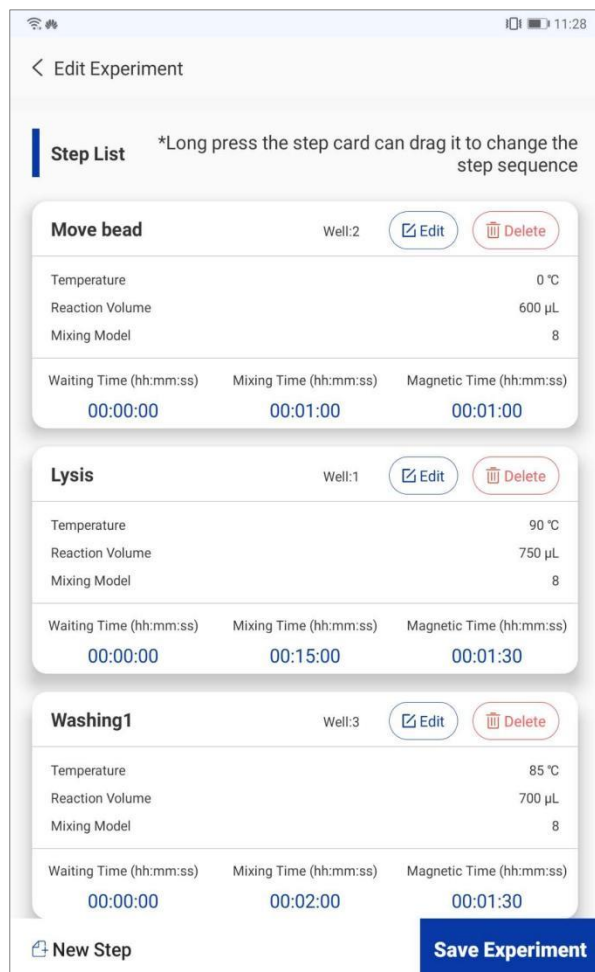

Figure 5-7. Experiment Interface - Edit Experiment Step and Parameter

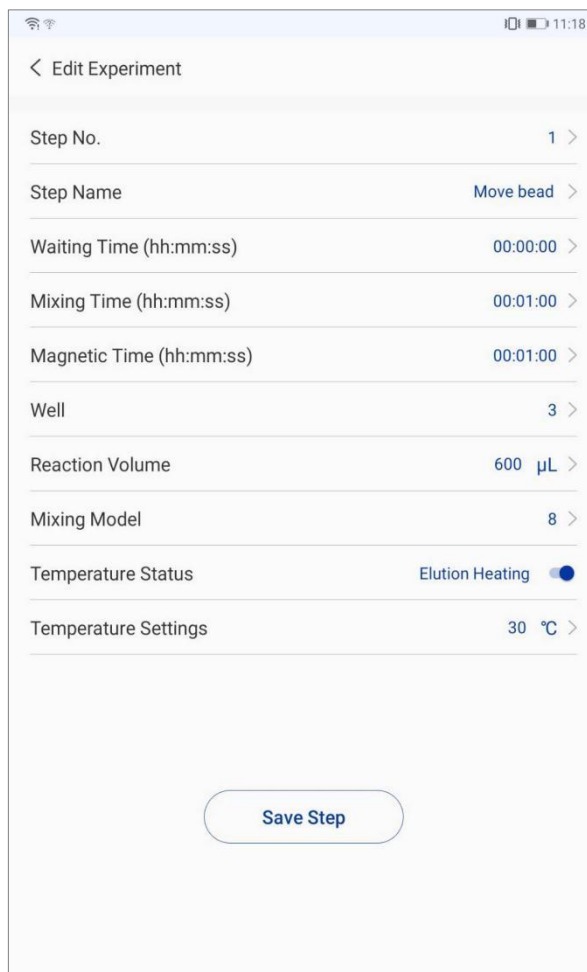



Figure 5-8. Experiment Interface - Edit Step Parameter

- **Step No.:** displays the current step number.
- **Step Name:** displays the current step name. Click here to edit the step name, which is limited to 20 characters at maximum.
- **Waiting Time:** user can set the waiting time of the current step, which is the time for liquid to volatilize after the magnetic rod covers are suspended in air of each step. It is generally suggested that the waiting time should be no more than 30 minutes.
- **Mixing Time:** user can set the time for liquid mixing by the magnetic rod cover of the current step.
- **Magnetic Time:** user can set the magnetic absorption time of the current step, which is the time for magnetic rods to adsorb magnetic beads. It is generally recommended that the magnetic absorption time should be more than 30 seconds;

- **Well:** there are six selectable well positions offered by the application software, user can select well position for the current step according to the experiment requirement.
 - **Mixing Mode:** there are eight selectable mixing modes offered by the application software, user can set mixing mode (Level 1 to 8 refer to different mixing speed of the magnetic rode cover from slow to fast) for the current step according to the experiment requirement.
 - **Reaction Volume:** user can set the reaction volume in the corresponding well of the deep-well plate, according to which the application software will adjust the height of the magnetic rode cover during mixing and magnetization steps.
 - **Temperature Status:** user can set temperature status of the current step that including Lysis Heating, Elution Heating and Close.
 - **Temperature Settings:** user can set the temperature for the current step.
- ▶ After finish editing the step, user can click < **Save Step** > to save current step settings and return to previous interface, as shown in figure 5-8.
- ▶ After finish editing the experiment, user can click < **Save Experiment** > to save current experiment settings and return to Experiment interface, as shown in figure 5-3.

5.2.2 Disinfection Interface

Click <  **Disinfection** > and the icon will change into <  **Disinfection** >, and the main interface will automatically switch to the Disinfection interface, where user can run/stop UV disinfection towards the instrument and set disinfection time, as shown in figure 5-9.

1. User can click < **Run** > to run the UV disinfection program, or click < **Stop** > to stop current running UV disinfection program.

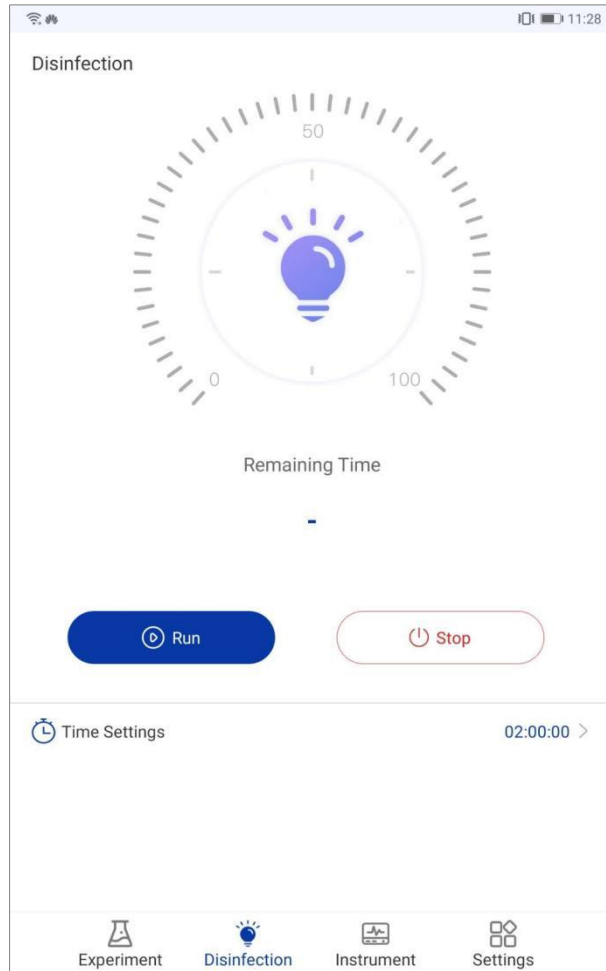

Figure 5-9. Application Software - Disinfection Interface



2. User can click <  **Time Settings** > to set the UV disinfection time, as shown in figure 5-10.



Figure 5-10. Disinfection Interface - Disinfection Time Setting

5.2.3 Instrument Interface

Click <  **Instrument** > and the icon will change into <  **Instrument** >, and the main interface will automatically switch to the Instrument interface, where user can view instrument status and current experiment list, as shown in figure 5-11.

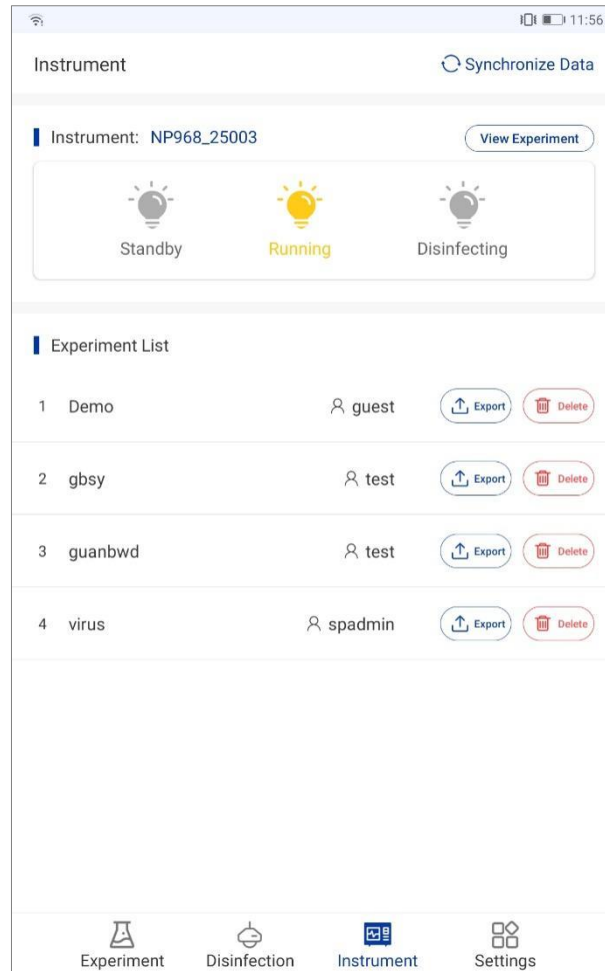







Figure 5-11. Application Software - Instrument Interface

1. User can view the running status of the current instrument(Standby, Running, Disinfecting).
2. User can click < **View Experiment** > to view the information of the current running experiment.
3. User can click <  **Synchronize Data** > in the upper right corner to synchronize the experiment in the current instrument to the experiment list on the Instrument interface.
4. Select any experiment in the experiment list and click <  **Export** > to export the selected experiment from the instrument system software to application software.
5. Select any experiment in the experiment list and click <  **Delete** > to delete the selected experiment.

5.2.4 Setting Interface

Click <  **Settings** > and the icon will change into <  **Settings** >, and the main interface will automatically switch to the Setting interface, where user can set general parameters for the instrument, as shown in figure 5-12.

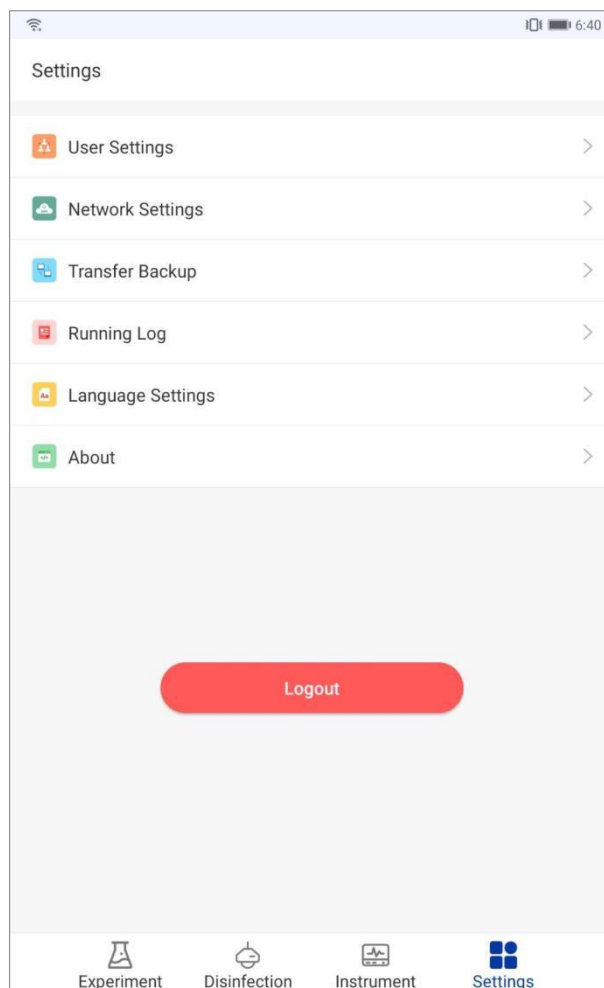

Figure 5-12. Application Software - Setting Interface

1. **User Settings:** intended to set the login user of the current application software, as shown in figure 5-13.

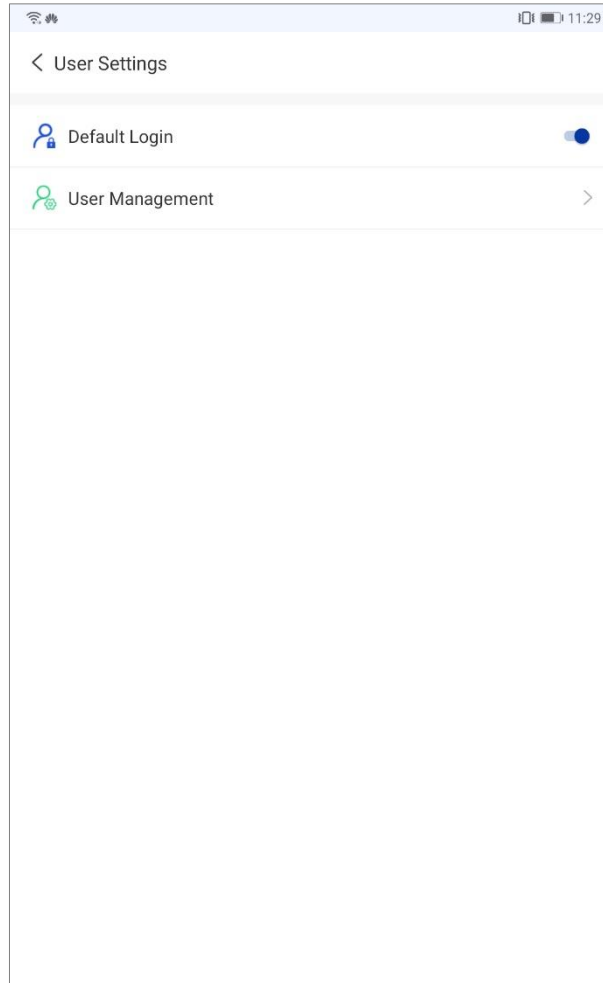



Figure 5-13. Setting Interface – User Settings

- ▶ **Default Login:** user can set whether to set the current user as the default login user.
 - ▶ **User Management:** user can click  to change login password of the current user.
2. **Network Settings:** intended to screen available NP968 Automated Nucleic Acid Extractors in LAN. User can click < **Screen Instrument** > and input the keyword for screening, then connect the corresponding instrument, as shown in figure 5-14.
- ⚠ **Reminding:** if no keyword input, all connectable devices in current LAN will be displayed.
 - ⚠ **Reminding:** user can input NP968_ to screen out all available NP968 Automated Nucleic Acid Extractors in current LAN.

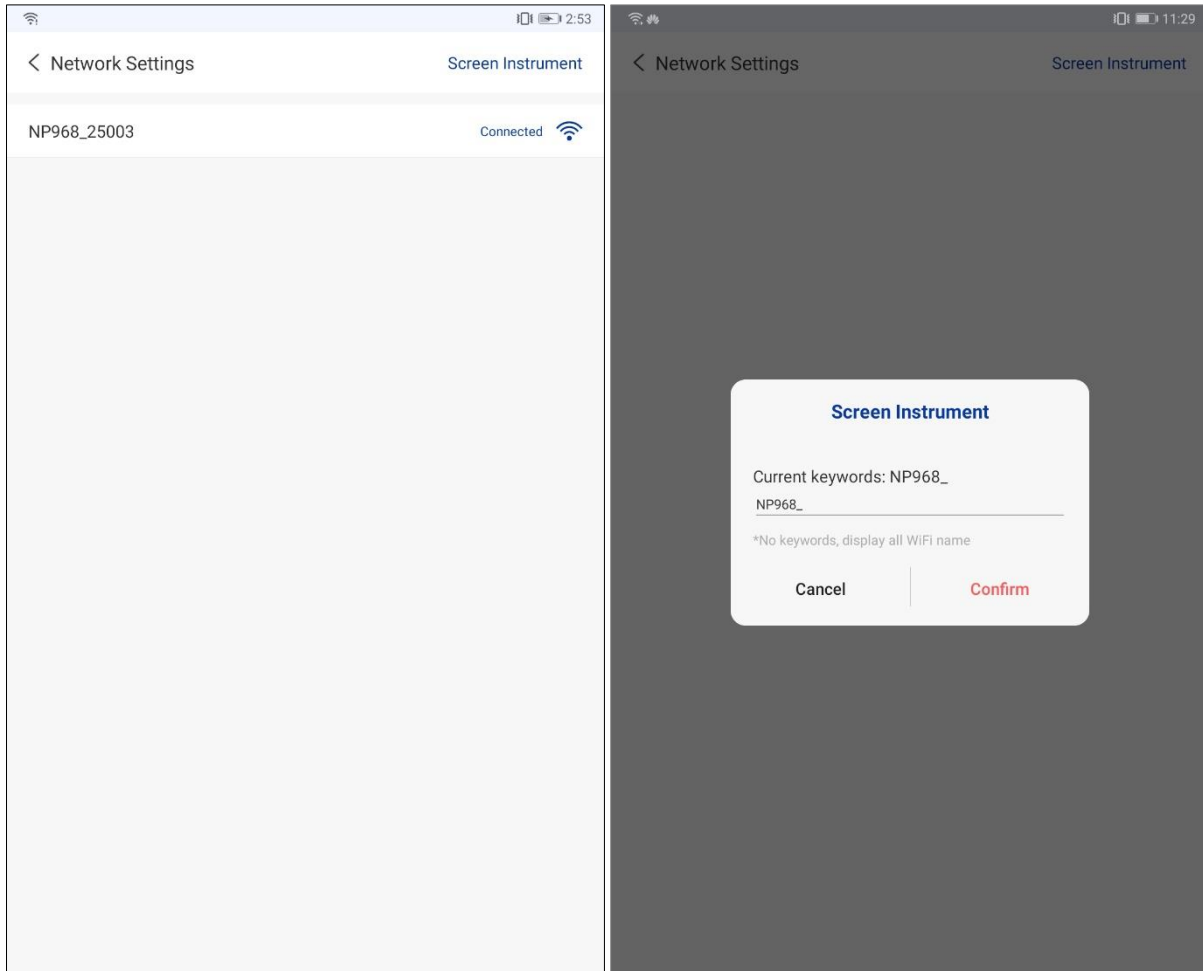

Figure 5-14. Setting Interface – Network Settings

- 3. Transfer Backup:** intended to transfer and back up the experiments between application software and tablet PC, as shown in figure 5-15.

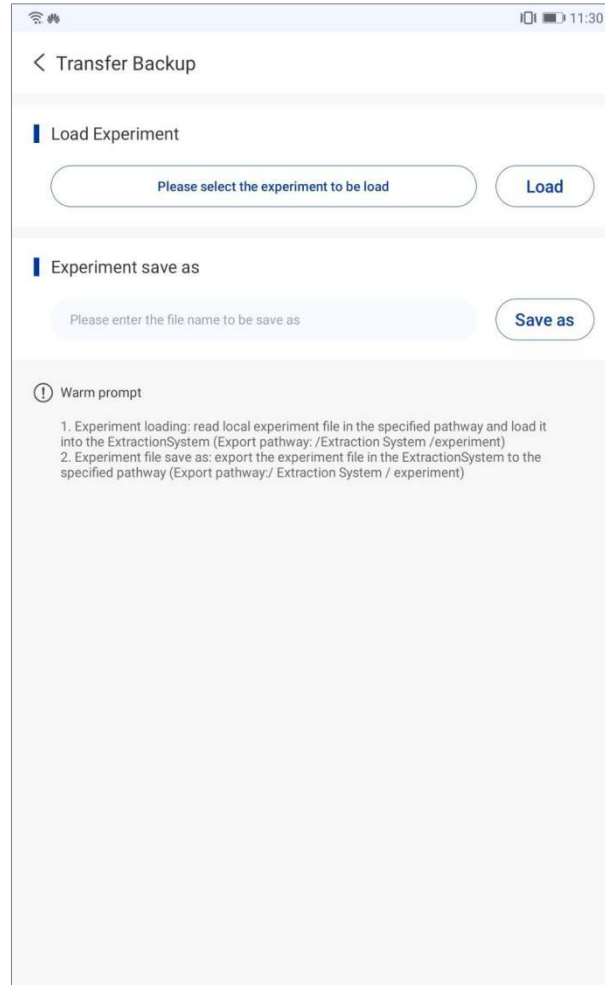

Figure 5-15. Setting Interface –Transfer Backup

- ▶ **Load Experiment:** user can click **< Load >** to select the experiment from the specified path in the tablet PC and load it into the application software.
 - ▶ **Experiment Save as:** user can click **< Save as >** and enter the desired experiment name to save the experiment from the application software to the specified path in the tablet PC.
4. **Running Log:** the application software can store the running log of each experiment. User can click **< Export >** in the upper right corner of the Running Log interface, select running log and click **< Export Log >** to export it/them to the specified path in the tablet PC, as shown in figure 5-16.

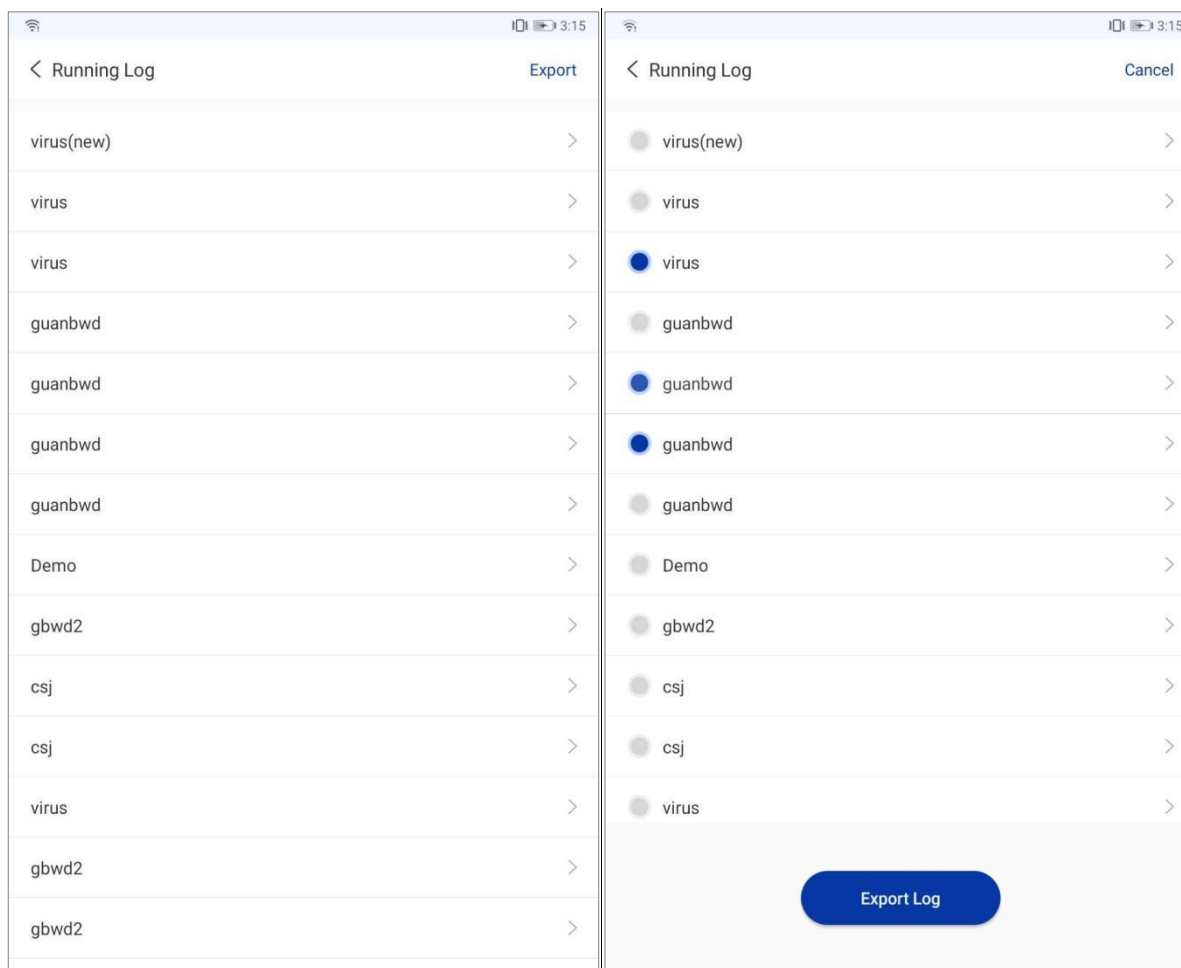

Figure 5-16. Setting Interface – Running Log

5. **Language Setting:** intended to set application software language, as shown in figure 5-17.
 - ▶ **Follow System:** If the option **Follow System** is selected, the application software language will follow the system language setting of the tablet PC, when the tablet PC system language is Chinese, the application software language will set to Chinese, and when the tablet PC system language is other than Chinese, the application language will set to English.
 - ▶ **Simplified Chinese:** If the option **Simplified Chinese** is selected, the application software language will be set to Simplified Chinese regardless of the tablet PC system language.
 - ▶ **English:** If the option **English** is selected, the application software language will be set to English regardless of the tablet PC system language.

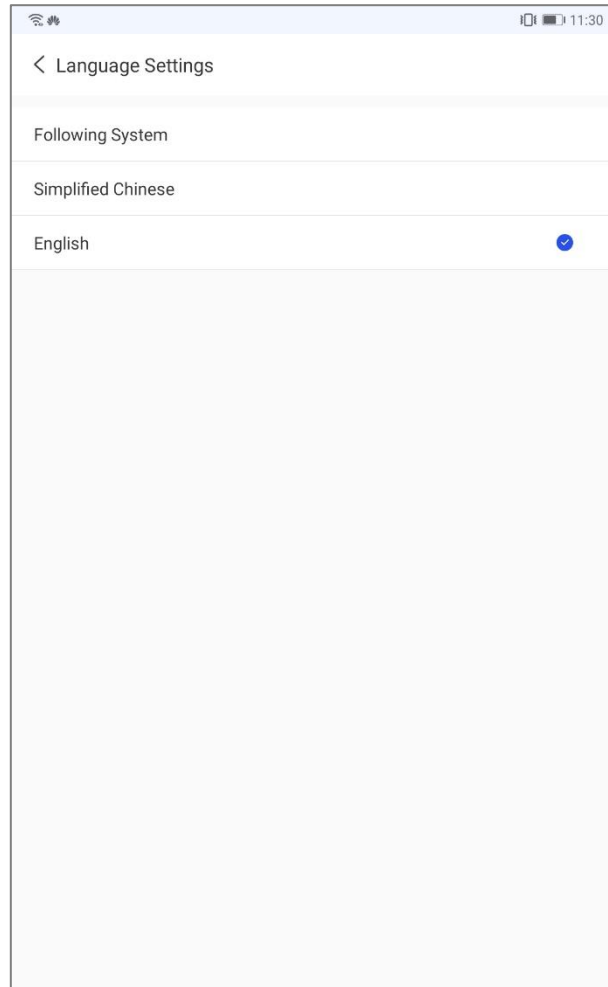

Figure 5-17. Setting Interface – Language Setting

- 6. About:** intended to view the version information of the current application software, as shown in figure 5-18.

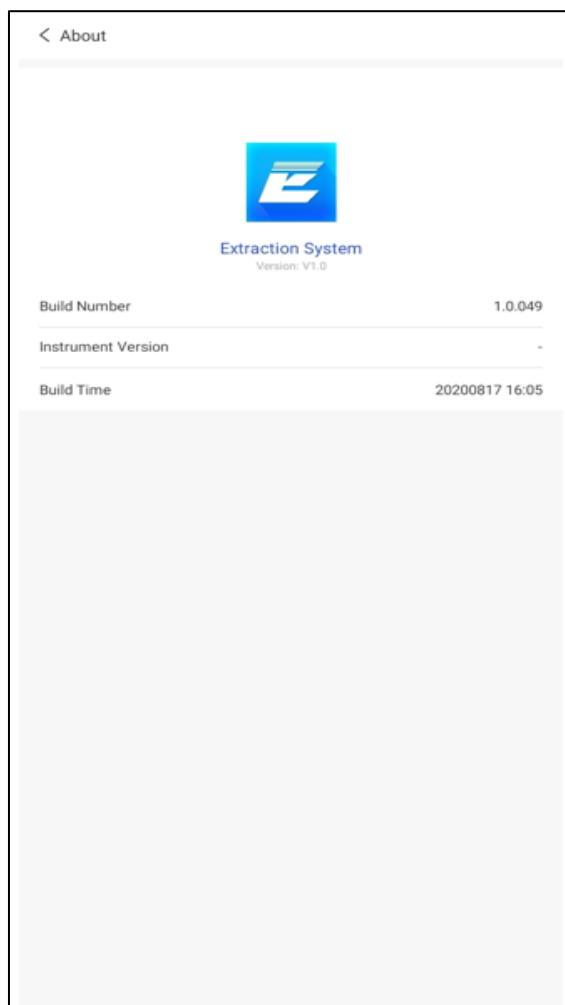



Figure 5-18. Setting Interface – About

5.3 Application Software Operation

The application software needs to run on a tablet PC installed with Android operating system.

5.3.1 User Login, Registration

Turn on the tablet PC and click the <  **Extraction System** >, the application software will automatically enter login interface, where user can enter their user name and password for login or register as a new user, as shown in figure 5-1.



5.3.2 Connect to Instrument

- 1) Open the WLAN switch of the tablet PC.
- 2) Login the application software, click <  **Settings** > → < **Network Settings** > to connect the corresponding instrument. For detail operation instructions, please refer to [5.2.4 Setting Interface – Network Settings](#).

5.3.3 Run Experiment

- 1) Click < **+ New Experiment** > in the upper right corner of the experiment interface, the New experiment interface will pop up automatically, as shown in figure 5-4. For detail operation instructions, please refer to [5.2.1 Experiment Interface – New Experiment](#).
- 2) After creating a new experiment, user can click < **Next Step** > to edit the experiment, as shown in figure 5-6, 5-7 and 5-8. For detail operation instructions, please refer to [5.2.1 Experiment Interface – Edit Experiment](#).
- 3) After the experiment edition, user should properly place the deep-well plate with reagents and the magnetic rod covers into the experiment cabin and close the door.
- 4) After placing the consumables, user can select the experiment on the Experiment interface and click < **Run** >, as shown in Figure 5-5. For detail operation instructions, please refer to [5.2.1 Experiment Interface – Run Experiment](#).

5.3.4 UV Disinfection

- 1) Once the experiment is completed, user should discard the consumables from the experiment cabin as soon as possible.
- 2) Click <  **Disinfection** > and the main interface will automatically switch to the Disinfection interface, as shown in figure 5-9.
- 3) User can click <  **Time Settings** > to set the UV disinfection time, and then click < **Run** > to run the UV disinfection program, as shown in figure 5-9. For detail operation instructions, please refer to [5.2.2 Disinfection Interface](#).

6. Maintenance

6.1 Regular Maintenance

The instrument requires little maintenance under proper operations. However, it should be cleaned and maintained on a regular schedule for long and constant usage. Maintain the instrument in correct manner, helps to prolong its lifespan. This section includes the information on cleaning and maintenance of the instrument:

- 1) Please carefully read the user manual before instrument usage.
- 2) For daily maintenance, please keep the instrument clean and without liquid residue.
- 3) Please clean the instrument surface on a regular schedule. It is suggested to clean the instrument with a piece of moist cloth and mild detergent. Please do not clean the instrument surface with strong detergent/acid/alkali/, organic solvents or with alcohol whose concentration is more than 75%, these solutions may damage the surface coating of the instrument.
- 4) In case there is any salt, acid, alkali solution or organic solvents spill on the instrument, please immediately clean in order to protect the instrument.
- 5) It is permissible to clean the instrument LCD screen with a piece of soft cloth, using 75% ethyl alcohol or routine laboratory detergent. Please do not directly spray any liquid on the screen and keypads.
- 6) Please always keep the experiment cabin dust-free and no liquid residue. Clean the plate area and base plate regularly (at least once a week) with SDS solution, 75% ethyl alcohol or suds. Never pour any liquid into the experiment cabin. Please use absorbent cotton or cotton cloth that moistened with detergent solution to clean the experiment cabin. Remember to cut off power supply before cleaning the instrument, in order to avoid instrument damage or personnel injure.
- 7) Please clean magnetic rod frame and magnetic rod cover frame with SDS solution, 75% ethyl alcohol or suds. Please avoid the usage of metal objects to protect magnetic rods from damage.
- 8) In case the instrument will not be used for a long time, please unplug its power cord and cover the device with a piece of soft cloth or a plastic bag to prevent dust from entering.
- 9) It is suggested to power on the instrument and run an experimental program without plates every 30 days to ensure the normal performance of instrument in case the instrument has not been used for a long time.

 **Warning:**

- a. Please clean the surface coating with routine laboratory detergent. Just follow the related usage and dilution instructions of the detergent. Never pour any high concentration of acid, base solution, ethyl alcohol or organic solvents on the surface coating of the instrument.
- b. Cover the instrument with the dust cover if the instrument will not be used for a long time. Do not place any heavy stuff on top of the instrument.
- c. The instrument contains permanent magnet field. Anyone who wears cardiac pacemaker or metal prosthetic device is not allowed to clean the instrument. The permanent magnet field may affect the functions of the cardiac pacemaker and metal prosthetic device, even result in personnel injuries.
- d. Even though the instrument has passed the security certification and testing, in order to avoid instrument damage or personnel injury, it is prohibited to clean the instrument while it is still running or when it is connected to the power supply.

6.2 Disinfection Treatment

If there is any liquid spill or splash in the experiment cabin, please make sure to disinfect the parts within the experiment cabin. In case user want to move the instrument from one laboratory to another, or transport it back to the distributor or after sale department for overhaul. Please confirm to disinfect the instrument first.

Please disinfect the instrument according to the general method of disinfection. In case user want to use special disinfectant, please refer to the corresponding disinfectant specifications for usage.

The specific operation instructions are as follow:

- 1) Wear protective clothing and medical disposable gloves.
- 2) Prepare the disinfectant in advance (general experimental disinfectant).
- 3) Power off the instrument and take out all the consumables within the experiment cabin.
- 4) Moisten the absorbent cotton or cotton cloth with the pre-prepared disinfectant.
- 5) Gently wipe the experiment cabin interior (including plate placing area, magnetic rods, magnetic rod frame, magnetic rod cover frame) with the absorbent cotton or cotton cloth.
- 6) Please wait until the experiment cabin interior is dry and clean it again with 75% ethyl alcohol. At the same time, please clean the instrument surface with general detergent.

7) Please wait until the experiment cabin interior and the instrument surface are dry. Power on the instrument and then switch on the UV lamp for UV lamp disinfection. It is suggested to set the disinfection time for 2 hours.

8) Please fill the disinfection certificate.



Warning: only trained professionals are allowed to perform the disinfection treatment. Please wear the protective cloth and medical disposable gloves during the disinfection treatment process, which should be performed in a well ventilated environment.

6.3 Package and Depot Repair

In case it is needed to send the instrument back to the distributor or the after sale department, please follow the instructions as below for packaging and transportation.

1) Thoroughly clean the instrument.

2) Comprehensively disinfect the experiment cabin interior according the instructions of '[6.2 Disinfection Treatment](#)', and provide the disinfection certificate.

3) Install the transport lock.

4) Wrap the instrument with plastic bag.

5) Inform the after sale department what kind of biohazard has been used.

6) Inform the after sale department the fault phenomenon that has been occurred and the parts need to be repaired.

7) Package the instrument with the original package to avoid the instrument damage. Any damage caused during the transportation will result in extra repair cost.



8) The transport and storage conditions please refer to '[2.3 Technical Parameters](#)'.



Warning: please first disinfect the instrument before transporting it back to the distributor or the after sale department for overhaul. Specific instructions please refer to '[6.2 Disinfection Treatment](#)'.

7. Troubleshooting and After-sale Service

In case any abnormality or error occurs while the instrument is running, it is suggested to stop the current running step. Please wait until the abnormality or error is solved, and then start to run the experimental program again from the beginning. The main possible errors of the Automatic Nucleic Acid Extractor and their corresponding corrective instructions are listed in the table as below.

No.	Phenomenon	Possible Causes	Corrective Instructions
1	No display on the screen after power on	Unstable power cord connection	Connect the power cord again or renew the power cord.
		Fuse tube is broken	Renew the fuse tube.
		Other	Contact us or the distributors.
2	Unable to enter the stand-by interface while starting up	Prompt 'Error code: EM0. EM1. EM2.' is shown	Contact us or the distributors.
		The prompt is shown as 'Test passed'	Restart the instrument. Contact us or the distributors in case this situation happened again.
3	Firmware upgrade failed	Unable to recognize the USB flash disk	Plug the USB flash disk again or change another USB flash disk
4	Abnormal noise of the instrument	The transport lock has not removed	Remove the transport lock
		The magnetic rod covers are at inappropriate positions.	Plug the magnetic rod cover again
		The 96 wells deep well plate is at inappropriate position.	Place the 96 deep well plate again at appropriate position.
5	Temperature does not rise while heating process	Check temperature control setting	Reset the experiment program temperature and download it to instrument.
		Other	Contact us or the distributors
6	UV lamp does not work	UV lamp is disconnected	Reinstall the UV lamp.
		UV lamp is damaged	Change the UV lamp.
		Experiment cabin door is open	Close the experiment cabin door
7	Magnetic rods misbehaving	Magnetic rods move without up and down motions	Press  to stop the program, press  to restart the program.
		Other	Contact us or the distributors

8	Magnetic rods are dropped		Contact us or the distributors
9	System crashed or out of control	Improper operation	Power off and restart the instrument
		Other	Contact us or the distributors

 **Reminding:** the fuse tube type of the Nucleic Acid Extractor is F10AH250V and it is installed between the power socket and the switch at the backside of the instrument. User could change the fuse tube following the steps below:

- a. Turn off the instrument
- b. Unplug its power cord.
- c. Open the fuse tube socket and take out the fuse tube.
- d. Check the integrity of the fuse tube and change the fuse tube if it is broken.
- e. Insert the fuse tube socket and plug the power cord.

 **Reminding:** For a patient/user/third party in the European Union and in countries with similar regulatory regime (Regulation 2017/746/EU on IVD Medical Devices); if, during the use of this device or as a result of its use, a serious incident has occurred, please report it to the manufacturer and/or its authorized representative and to your national regulatory authority.

8. Contact Information



Xi'an Tianlong Science and Technology Co., Ltd.

No.4266, Shanglin Road, Weiyang District, Xi'an, 710021, Shaanxi, P.R. China

Postcode:710021

Company Tel: +86-29-82682132

Company Fax: + 86-29-82216680

Email Address: inquiry@medtl.com

Website Address: www. medtl.net



SUNGO Europe B.V.

Fascinatio Boulevard 522, Unit 1.7, 2909VA Capelle aan den IJssel, The Netherlands.

Tel: +31(0)10 3034500; +31(0)2021 11106

Email Address: ec.rep@sungogroup.com

Annex I . Laboratory Manual

1. Purpose

The purpose of this manual is to combine the use of the Automatic Nucleic Acid Extractor with its reagents. Help user to quickly understand the operation procedure and be skilled in operation.

2. Operation Procedures

Please choose magnetic beads reagents before performing nucleic acid extraction with the instrument. Generally, the magnetic beads reagents contain different components to realize the purpose of nucleic acid extraction. Take **XATL** virus DNA extraction magnetic beads reagent for instance, it is consisted of lysis buffer, proteinase K, acryl carrier, magnetic beads buffer, wash buffer I, wash buffer II, wash buffer III and elution buffer.

Attached Table 1. Different component functions of magnetic beads reagent

Reagents	Function
Lysis Buffer, Proteinase K	Lyse cells to release the nucleic acid from the cells.
Magnetic Beads Buffer	Adsorb the nucleic acids that released from the cells.
Wash Buffer I, II, III	Wash out other substances except the extracted nucleic acid, such as protein, polysaccharide, etc.
Elution Buffer	Elute the nucleic acids that adhered to magnetic beads.
Acryl Carrier	Increase the nucleic acid precipitation rate when performing ethanol precipitation.

 **Reminding:** the composition and concentration of each reagent are different depend on the different samples to be used. Please choose the suitable reagents strictly according to the classification of the samples.

2.1 DNA Extraction

This section introduces the operation steps of DNA extraction with the Automatic Nucleic Acid Extractor. For example, extract DNA with XATL virus DNA extraction magnetic beads reagent kit.

2.1.1 Materials

- 96 deep well plate;
- Tips with appropriate capacity;
- Absolute ethyl alcohol;
- Isopropyl alcohol.

2.1.2 Components of XATL virus DNA extraction magnetic beads reagent kit

Attached Table 2 Components of XATL virus DNA extraction magnetic beads reagent kit

Components	Amount
Lysis Buffer	12mL×1
Wash Buffer I	18mL×1
Wash Buffer II	6mL×1
Wash Buffer III	30mL×1
Elution Buffer	5mL×1
Magnetic Beads	1.0mL×1
Acryl Carrier	200μL×1
Protease K	14mg×1

2.1.3 Pre-preparation

Please prepare the protease K, lysis buffer, wash buffer I, wash buffer II following instructions of the kit before usage.

2.1.4 Sample types

- Blood serum;
- Blood plasma;
- Tissue extract;
- Swab-based lotion;
- No cell body fluid;
- Virus medium;
- Urine; etc.

2.1.5 Operation steps (For example: extract virus DNA from blood serum)

- a. Please add sample and reagents to the rows of wells on the 96 deep well plate, as shown in the following table.

Attached Table 3 The arrangement of reagent and well on the 96 deep well plate

Row	Reagents	Volume
1 and 7	10 μ L Protease K + 4 μ L Acryl Carrier + 200 μ L Sample + 300 μ L Lysis Buffer + 20 μ L Magnetic beads	534μL
2 and 8	Washing buffer I & absolute ethyl alcohol mixture	500μL
3 and 9	Washing buffer II & absolute ethyl alcohol mixture	500μL
4 and 10	Washing buffer III	550μL
5 and 11	Blank	
6 and 12	Elution buffer	100μL

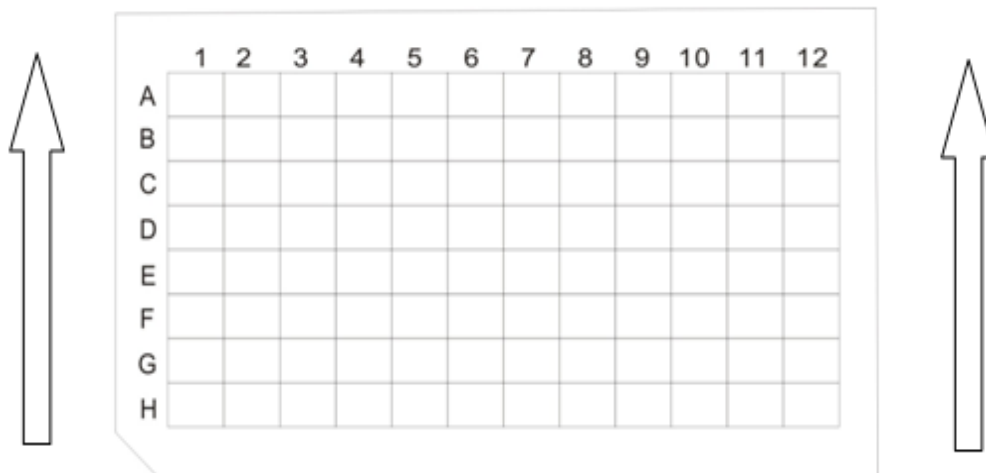

- The lysis buffer, washing buffer, protease K are all pre-prepared.
- Row 1 refers to the left most row of wells on the 96 deep well plate.
- Please mix the reagents and ensure their uniformity before adding them to wells.
- Please make sure that the Elution buffer is at the 6th and 12th rows of 96 deep well plate.



Attached Figure 1 Diagram of 96 Deep Well Plate

- b. Place the 96 deep well plate in the Automatic Nucleic Acid Extractor and ensure the gap of the plate is facing outwards.
- c. Insert the magnetic rod covers into magnetic rod cover frame.
- d. Close the experiment cabin door.
- e. Edit the experimental program as shown in the table below.

Experiment name			TL-DNA						
Remark									
Step	Well	Name	Waiting Time	Mixing Time	Magnet Time	Mixing Mode	Volume (μL)	Temp. Status	Temp. (°C)
1	1	Lysis	00:00:00	00:10:00	00:00:00	7	534	Lysis	90
2	1	Combine	00:00:00	00:10:00	00:01:30	7	534	Closed	--
3	2	Washing1	00:00:00	00:02:00	00:01:30	7	500	Elution	80
4	3	Washing2	00:00:00	00:02:00	00:01:30	7	500	Elution	80
5	4	Washing3	00:00:00	00:00:00	00:00:30	1	550	Elution	80
6	6	Elution	00:00:00	00:05:00	00:01:30	7	100	Elution	80
7	2	Release	00:00:00	00:01:00	00:00:00	5	500	Closed	--

-  **Reminding:** the above mentioned preparation procedure and experimental program is based on the XATL virus DNA extraction magnetic beads reagent kit. In case user want to use other reagent kit, please edit the experimental program according to the corresponding instructions.
- f. Press the <  **Experiment** > icon on the main interface and enter the experiment manage interface. Select the experimental program to be run. Press < **Run** >, the detailed information of the selected experiment will be shown. Press < **Run** > again to start up running the selected experimental program. For more details, please refer to the section of '4.3.1Run and View an Experiment'.
- g. After finishing the experimental program, please take the samples located at the 6th and the 12th row of the 96 deep well plate and maintain them in EP tubes at -20°C.

3. Experiment process and matters needing attention

1. Please ensure to open the experiment cabin door and remove the transport lock, before plugging the instrument power cord for first time usage.
2. Please check the integrity of instrument and power source before plugging the instrument power cord and operating the instrument.
3. Add the sample and regents to the corresponding wells on the 96 deep well plate as the experiment requirements.
4. Place the 96 deep well plate into the experiment cabin and push the magnetic rod covers into the right position. Carefully check the magnetic rod covers position, otherwise it may cause instrument dysfunction and affect the experiment result.

 **Reminding:** please ensure the 96 deep well plate is in the appropriate place and its gap is facing outwards.

 **Reminding:** please ensure the magnetic rod covers are in the right position.

5. Close the experiment cabin door, edit a new experimental program or select a pre-exited experimental program, press  to start running.
6. If there is no instrument dysfunction or special experiment requirement, please do not open the experiment cabin door while the experiment is still running. Such as the need to open the experiment cabin door, please suspend the running experiment first.

7. User could hear the buzzer beeps when the instrument has finished experimental program running.

 **Warning:** the used magnetic rod covers and 96 deep well plates should be recycled and disposed following relevant regulations.

 **Warning:** using expired or unsuitable reagent kit, we cannot guarantee the desired experiment results.

Annex II. Product Accessories List

Packing List

No.	Accessory	Qty.
1	Host	1
2	Power Cord	1
3	Operation Manual	1
4	Fuse Tube	2
5	Quality Certificate	1
6	Packaging List	1
7	Packaging Bag	1
8	96 deep well plate	2
9	Mixing Sleeve	4
10	Cross Screwdriver	1



TIANLONG

Xi'an Tianlong Science and Technology Co.,Ltd.

Add: No.4266, Shanglin Road, Weiyang District, Xi'an, 710021, Shaanxi, P.R. China

Tel: +86-29-8268 2132

Fax: +86-29-8221 6680

<https://www.medtl.net>
